

the association for computational heresy

presents

a record of the proceedings of

SIGBOVIK 2020

*the fourteenth annual intercalary robot dance party in celebration
of workshop on symposium about 2⁶th birthdays; in particular,
that of harry q. bovik*

*cover art by chris yu
global chaos courtesy of sars-cov-2*

carnegie mellon university

pittsburgh, pa

april 1, 2020



Association for Computational Heresy

Advancing computing as Tomfoolery & Distraction

SIGBOVIK

A Record of the Proceedings of SIGBOVIK 2020

ISSN 2155-0166

April 1, 2020

Copyright is maintained by the individual authors, though obviously this all gets posted to the Internet and stuff, because it's 2020.

Permission to make digital or hard copies of portions of this work for personal use is granted; permission to make digital or hard copies of portions of this work for classroom use is also granted, but seems ill-advised. Abstracting with credit is permitted; abstracting with credit cards seems difficult.

Additional copies of this work may be ordered from Lulu; refer to <http://sigbovik.org> for details.



SIGBOVIK 2020

Message from the Organizing Committee

For generality's sake, we have templated the message of the organizing committee. The actual message may be produced by running the TeX command at the end.

```
\newcommand{\Message2020}[3]{  
% TODO: generalize ordinal indicators
```

Friends, family, colleagues, acquaintances for whom we have not yet overcome the activation energy to engage with regularly, and strangers doomed to the same fate: The Association of Computational Heresy welcomes you to the #1th annual meeting of the Special Interest Group on Harry Q#2 Bovik in celebration of Bovik's #3th birthday. In lieu of data about the submission and review process this year, we encourage you to ponder the perils of empiricism as well as our innovations in the publishing process: most notably, triple-blind peer review. In plain English, we have the following definition.

triple-blind peer review /'tripl-blaiɪnd pi:r ri'vju:/ *noun*

1. Scholarly peer review that minimizes bias by concealing not only the identities of the authors and reviewers from each other, but also by concealing the papers from the reviewers. Compare: single- and double-blind peer review.

However, let us undertake some performative formalization. Given a set of names of authors (*auth*) and reviewers (*rev*), we consider the role of author and reviewer as, under the Curry-Howard correspondence, proofs of the following higher-order linear logic propositions/processes conforming to the following protocols.

$$\begin{aligned} \vdash P &:: (c : \exists_{a:\text{auth}, p:\text{paperBy}(a)} \forall_{r:\text{rev}} \text{reviewOfBy}(p, r) \multimap \text{bool}) \\ \vdash Q &:: (d : \forall_{a:\text{auth}, p:\text{paperBy}(a)} \exists_{r:\text{rev}} \text{reviewOfBy}(p, r)) \end{aligned}$$

Under duality, it is clear that communication between P and Q is sound. Then, each level of blindness (single to triple) is achieved by successively abstracting the definition of *rev* for P then *auth* and *paperBy* for Q respectively; we refer to the work of Harper and Lillibridge [1] on translucent

First name	Last name	Email	Organization	Role	Last access	info	update	delete	login as
Sol	Boucher	sboucher@cmu.edu	Association for Computational Heresy	chair	Jan 18, 22:42				
Jenny	Lin	jennylin@andrew.cmu.edu	Association for Computational Heresy	chair	never				
Siva	Somayyajula	ssomayya@andrew.cmu.edu	Association for Computational Heresy	chair	NEVER				

Figure 1: never say NEVER

sums to achieve this. Higher-order notions of blind review require a stronger metatheory like a linear temporal-linear logical framework (that’s TWO linears!); we encourage future work to investigate this idea. Now that the general chair has redeemed himself for not submitting a paper this year, we would like to thank our authors and reviewers for their phenomenal work and for adjusting to the new review process as well as the continuous effort of volunteers who have made this year’s conference possible, which include but are not limited to: Chris Yu for the cover art, Catherine Copetas for managing our finances and other administrative concerns, and Ryan Kavanagh for organising the organisers. Moreover, the program chair also thanks Rose Bohrer and Stefan Muller for further advice. Lastly, we would like to thank Sol Boucher for assembling the proceedings as well as Jenny Lin and Siva Somayyajula for never working in various capacities (see figure 1).

The SIGBOVIK 2020 Organising Committee
Pittsburgh, PA

Jenny Lin (easy chair)
Siva Somayyajula (generalized hard-ass chair)
Sol Boucher (fold-out couch)
Rose Bohrer (reclining chair)
Ryan Kavanagh (rockin’ chair)
Chris Yu (swivel chair)
Stefan Muller (ergonomic office chair)

```
}
\Message2020{14}{uarantine}{{2^6}}
```

References

- [1] HARPER, R., AND LILLIBRIDGE, M. A type-theoretic approach to higher-order modules with sharing. pp. 123–137.

Blindsight is 2020

: Reading Skills	3
1 Anonymous paper	4
2 State-of-the-Art Reviewing: A radical proposal to improve scientific publication	9
: SIGBOVIK	17
3 A thorough investigation of the degree to which the COVID-19 pandemic has enabled subpar-quality papers to make it into the proceedings of SIGBOVIK, by reducing the supply of authors willing to invest the necessary effort to produce high-quality papers	18
4 Is this the longest Chess game?	20
5 Optimizing the SIGBOVIK 2018 speedrun	32
6 Retraction of a boring follow-up paper to “Which ITG stepcharts are turniest?” titled, “Which ITG stepcharts are crossoveriest and/or footswitchiest?”	35
: Programming Languages	37
7 Ntinuation copassing style	38
8 Formulating the syntactically simplest programming language	40
9 Type-directed decompilation of shell scripts	48
10 Verified proof of P=NP in the Silence theorem prover language	51
: Systems	55
11 SIGBOVIK ’75 technical note: Conditional move for shell script acceleration	56
12 NaN-gate synthesis and hardware deceleration	61
13 hbc: A celebration of undefined behavior	66
: Theory	71
14 A polynomial-time SAT algorithm	72
15 Empire Machines and beyond	73
16 Artificial General Relativity	81
17 Lower gauge theory: Dead duck or phoenix?	87
18 Making explicit a constant appearing in an impossible equation of Carl and Moroz	88
: Security	93
19 Determining the laziest way to force other people to generate random numbers for us using IoT vulnerabilities	94
20 Putting the ceremony in “authentication ceremony”	102
: Artificial Intelligence & Machine Learning	109
21 Image2image neural network for addition and subtraction evaluation of a pair of not very large numbers	110
22 Robot ethics: Dangers of reinforcement learning	113
23 Learning to be wrong via gradient ascent: A broken clock is right twice a day, but a clock that runs backwards can be used to tell the time!	116

24	GradSchoolNet: Robust end-to-end *-shot unsupervised deepAF neural attention model for convexly optimal (artificially intelligent) success in computer vision research	121
: Natural Intelligence & Human Learning		257
25	Sorting with human intelligence	258
26	Synthesizing programs by asking people for help online	264
27	HonkFast, PreHonk, HonkBack, PreHonkBack, HERS, AdHonk and AHC: The missing keys for autonomous driving	266
: Education		271
28	A disproof of the Theorem of Triviality	272
29	Visualizing player engagement with virtual spaces using GIS	273
30	How to <code>git bisect</code> when your test suite is having a bad day	282
: Blockchain Gang		289
31	RegisToken	290
: The SIGBOVIK 2020 Field Guide to Conspiracy Theories		299
32	Faking ancient computer science: A special SIGBOVIK tutorial	300
33	MORSE OF COURSE: Paper reveals time dimension wasted	308
34	The Pacman effect and the Disc-Sphere Duality	310
: Serious Business		315
35	The SIGBOVIK 2020 field guide to plants	316
36	Deep industrial espionage	320
37	What is the best game console?: A free-market-based approach	327
: Funny Business		337
38	Can a paper be written entirely in the title? 1. Introduction: The title pretty much says it all. 2. Evaluation: It gets the job done. However, the title is a little long. 3. Conclusion: Yes.	338
39	Erdős-Bacon-Sabbath numbers: <i>Reductio ad absurdum</i>	341

Reading Skills

1 **Anonymous paper**

Anonymous Author

Keywords: anonymous, triple blind, review

2 **State-of-the-Art Reviewing: A radical proposal to improve scientific publication**

Samuel Albanie, Jaime Thewmore, Robert McCraith, João F. Henriques

Keywords: peer review, SotA, State-of-the-Art, computer vision, machine learning

Dear Author,

Thank you very much for your submission

'Anonymous Paper'

We are sorry to inform you that your paper was rejected. The venue received a great many submissions of high quality. Each submission was thoroughly and extensively reviewed by our expert panels. After week-long online and offline discussions, we selected a small subset of papers to be accepted. Unfortunately, your paper was not one of them.

We have enclosed detailed reviews of your paper below. We hope that these will help you in your scientific work and look forward to your future submissions!

Reviewer 2

Generally speaking, this is interesting work which may well find some readers in the community. However, in its present form, the paper suffers from a number of issues, which are outlined below.

Abstract

This paper, titled 'Anonymous Paper,' one more time addresses the problem of Anonymity in SIGBOVIK. The approach is novel, and is well-described in the paper. Yet, it is only incremental with respect to the state of the art. This especially holds when compared against the latest works of Anonymous Author. The approach is shown to work only in theory; but despite its obvious limitations, it is shown to have potential under specific circumstances.

Area

SIGBOVIK is not new. The past decade has seen a flurry of papers in the area, which would indicate progress and interest. However, the impact *outside* of SIGBOVIK has been very limited, as is easily reflected in the ever-decreasing number of citations. Unfortunately, SIGBOVIK finds itself in a sandwich position between a more theoretical community and a more practical community, which can both claim a bigger intellectual challenge and a greater relevance in practical settings. This is especially true for the field of Anonymity, where the last big progress is now decades ago. As refreshing it feels to finally again see progress claimed in the field, the present paper must be read and evaluated in this context.

Originality

The central problem of the paper is its novelty with respect to related work. Just last month, this reviewer attended a talk on Anonymous Paper by Anonymous Author at Anonymous Institution where a very similar solution to the exact same problem was presented. The paper is actually online at

<http://scigen.csail.mit.edu/cgi-bin/scigen.cgi?author=Anonymous%20Author>

Please relate your work carefully against this existing work, precisely highlighting the advances.

Approach

The approach is novel in the sense that the exact same approach has not been examined before.

A central problem with the approach is that the difference with respect to earlier work is simply too small. An incremental approach such as this one may be appreciated in practice, as it may easily integrate into existing processes; but for a research paper, the community expects bigger leaps.

The paper suffers from an excess of formalism. Several important definitions are introduced formally only, without a chance to clearly understand their motivation or usage. The authors should be encouraged to make more use of informal definitions, building on the well-established formal definitions in the community.

It is good to see the approach scale to real-life settings. The price of scalability, however, is having to cope with a multitude of details, which the paper only glosses over, without ever providing a complete picture. The authors would be better served to provide a tangible abstraction of their approach; maybe it only works in limited settings, but at least, for these, we can understand how and why.

The authors should be happy to see their approach being used outside of academia. However, this challenges the novelty of the present submission: Not only is the approach no longer superior to the state of the art, it even is not longer superior to the state of the practice - ironically, because it now defines what the current state of practice is. The submission had better be framed as an experience report and target non-academic readers.

Evaluation

As nice as it is to see the approach defined and its properties discussed, it *has* to be evaluated whether it works on actual subjects. Without a detailed evaluation, we can never know whether the claimed properties also hold under less abstract and less favorable circumstances.

Limitations

The section on 'threats to validity' pretty much sums everything up: The approach cannot claim external validity (no surprise, given the evaluation results); on top, *the authors themselves* list

important threats to internal and construct validity.

The fact that the authors themselves apparently cannot list future work fits into this very picture. This is a clear indication of work being stuck in an impasse; if one ever needed a living proof how Anonymity has become the laughingstock of the SIGBOVIK community, or how SIGBOVIK is more and more becoming a dead branch of science, here it is. With so many threats and limitations, it is unclear whether the paper can be published at all, even in a thoroughly revised form.

Reproducibility

Your code and data are not available as open source. Being unavailable for the general public, there is no way for readers (or this reviewer) to validate your claims, which is a strict requirement for a scientific contribution. Please submit it as an electronic appendix with the next revision.

Presentation

The typography of your paper is a disgrace. Respect the style instructions as given by the publisher. Respect paper lengths. Do not cheat with super-small fonts. Learn what good typography is. Learn how to use LaTeX, and how to use LaTeX properly. Do not use multi-letter identifiers in LaTeX math mode. Distinguish - (hyphen) between elements of compound words, -- (en-dash) in ranges, \$-\$ (minus) for math, --- (em-dash) for digressions in a sentence. use the correct quotes (` and "). In BibTeX, capitalize titles properly. Use \dots rather than This reviewer stops here.

The paper has numerous presentation issues. The paper contains numerous typos - Page 2, for instance, has a period '.' instead of a comma ','. This is a sign of careless proofreading, and ultimately disrespect - if the authors do not care about their paper, why should the reader care? At least *try* to produce a polished version for submission.

Keep in mind that a high number of presentation issues eventually will hinder the readers and reviewers to understand what your work is about. Should you find misunderstandings in the above review, ask yourself what you could have done to avoid these.

Summary

Points in favor: (+) An interesting approach to Anonymity in SIGBOVIK (+) Paper does a good attempt at describing the approach

Points against: (-) Far away from scientific mainstream (-) Incremental (-) Insufficient evaluation (-) Substantial presentation issues

Recommendation

Reject.

Footnote

Generated by autoreject.org



CONFIDENTIAL COMMITTEE MATERIALS

SIGBOVIK'20 3-Blind Paper Review

Paper 1: Anonymous paper

Reviewer: Definitely not the SIGBOVIK webmaster

Rating: 3rd grade reading comprehension

Confidence: Confident that some cool people said to email reviews to the sigbovik-reviews mailing list and *not* to easychair

Conference website	http://sigbovik.org/2020
Submission link	https://easychair.org/conferences/?conf=sigbovik2020
Abstract registration deadline	March 13, 2020
Submission deadline	March 13, 2020

Note that this is the appropriate way to submit papers but *not* reviews, triple-blind or otherwise. See the website for details on *that* process: sigbovik.org/2020

By submitting to SIGBOVIK 2020, I solemnly affirm all of the following:

- My submission does not have page numbers.
- I have the rights to use all images that appear in my submission.
- My submission *really* does not have page numbers. Not even a little bit.
- Page numbers are only permitted if they are *really* necessary for some incredibly niche joke. We're dead serious.

Figure 1: The easychair *paper* submission site

conference date. We welcome prerecorded videos from those who cannot physically make it to SIGBOVIK!

New: To submit your triple blind review, download [The Official Incredibly Secure Extra Blind SIGBOVIK Review Template \(in LaTeX\)](#). After filling out `review-template.tex`, send just your edited `review-template.tex` to sigbovik-reviews@lists.andrew.cmu.edu (the included .cls file is just so you can see the compiled result). If you are displeased by the look of templates for alternate document presentation systems, you may send your own template to sigbovik-reviews@lists.andrew.cmu.edu.

Figure 2: The SIGBOVIK 2020 website instructions for submitting reviews

STATE-OF-THE-ART REVIEWING: A RADICAL PROPOSAL TO IMPROVE SCIENTIFIC PUBLICATION

Samuel Albanie, Jaime Thewmore, Robert McCraith, Joao F. Henriques
SOAR Laboratory,
Shelfanger, UK

ABSTRACT

Peer review forms the backbone of modern scientific manuscript evaluation. But after two hundred and eighty-nine years of egalitarian service to the scientific community, does this protocol remain fit for purpose in 2020? In this work, we answer this question in the negative (strong reject, high confidence) and propose instead *State-Of-the-Art Review* (SOAR), a novel reviewing pipeline that serves as a “plug-and-play” replacement for peer review. At the heart of our approach is an interpretation of the review process as a multi-objective, massively distributed and extremely-high-latency optimisation, which we scalarise and solve efficiently for PAC and CMT-optimal solutions.

We make the following contributions: (1) We propose a highly scalable, fully automatic methodology for review, drawing inspiration from best-practices from premier computer vision and machine learning conferences; (2) We explore several instantiations of our approach and demonstrate that SOAR can be used to both review prints and pre-review pre-prints; (3) We wander listlessly in vain search of catharsis from our latest rounds of savage CVPR rejections¹.

If a decision tree in a forest makes marginal improvements, and no one is around to publish it, is it really “state-of-the-art”?

George Berkeley,
*A Treatise Concerning the Principles of
Human Knowledge (1710)*

1 INTRODUCTION

The process of *peer review*—in which a scientific work is subjected to the scrutiny of experts in the relevant field—has long been lauded an effective mechanism for quality control. Surgically inserted into the medical field by the cutting-edge work of (Ali al Rohawi, CE 854–931), it ensured that treatment plans prescribed by a physician were open to criticism by their peers. Upon discovery of a lengthy medical bill and a dawning realization that theriac was not the “wonder drug” they had been promised, unhappy patients could use these “peer reviews” as evidence in the ensuing friendly legal proceedings.

Despite this auspicious start, it took many years for the peer review protocol to achieve the popular form that would be recognised by the layperson on the Cowley Road omnibus today. Credit for this transformation may be at least partially attributed to the Royal Society of Edinburgh who were among the first to realise the benefits of out-sourcing complex quality assessments to unpaid experts (Spier, 2002).

Effacing the names of these heroic contributors, in a process euphemistically called *anonymous review*, was a natural progression. Attempts to go further and have the reviewers retroactively pay

¹W.A/W.A/B → Reject. A single heavily caffeinated tear, glistening in the flickering light of a faulty office desk lamp, rolls down a weary cheek and falls onto the page. The footnote is smudged. The author soldiers on.

for the privilege of reading a now-copyrighted manuscript (at the discounted price of £50) somehow did not catch on, despite the publishers’ best intentions. Peer review (not to be confused with the French tradition of *Pierre review*, or indeed the spectacle of a *pier revue*) has since gone from strength-to-strength, and is now the primary quality filtration system for works of merit in both the scientific and TikTok communities.

Still, something is rotten in the state of reviewing. To determine what exactly is causing the smell, our starting point in this work is a critical review of peer review. We begin by highlighting three key shortcomings of the existing system.

Ability to Scale. As anyone who has prepared for a tech internship interview knows, scale is important. And so are corner cases. And so is good communication. But the greatest of these is scale. To avoid carelessly ruling out future careers at Google, we therefore demonstrate an appreciation of the critical importance of this phenomenon. Indeed, it is here that we must mount our first attack on peer review: the algorithm is provably $\mathcal{O}(p)$, where p is the number of peers. To concretise the implications of this runtime complexity, consider the nation of the United Kingdom which occupies a small number of green and pleasant islands ’twixt the United States and Europe. There are, at the time of writing, 814 hereditary peers in the UK who can be called upon as professional peers. Of these, 31 are dukes (7 of which are royal dukes), 34 are marquesses, 193 are earls, 112 are viscounts, and 444 are barons. Many of these, however, do not sit in the House of Lords (an Airbnb property in which peers can be recruited to review documents), and so cannot be relied upon here. Fortunately, the vast majority of the 789 members of the House are instead peerages “#4lyF”—these are ephemeral honours which are somewhat easier to create because they do not require building new humans from scratch from a limited set of eligible bloodlines. Nevertheless, short of a fairly sizeable second “Loans for Lordships” political scandal, it is hard to foresee the kind rapid growth in the peerage ranks that is needed to meet reviewing demand. We also note here a second concern: for various technical reasons², only one hereditary position of the house is held by a woman (Margaret, 31st Countess of Mar), which raises questions about not only the *scale*, but also the *diversity* we can expect among the potential reviewing pool.

Speed. The mean age of the House of Lords was 70 in 2017. With a lack of young whippersnappers amidst their ranks, how can we expect these venerable statesmen and stateswomen to do the all-nighters required to review ten conference papers when they are only reminded of the deadline with two days notice because of a bug in their self-implemented calendar app? One solution is to ensure that they take care when sanitising date/time inputs across time-zones. But still, the question remains: how long does peer review really take? Since public data on this question is scarce, we turn to anecdotal evidence from our latest round of reviewing. The results were striking. We found that *any conference review paper batch is likely to contain at least one paper that takes at least ten hours to review*. The blame for these “time bombs” lies with both authors *and* reviewers, since they arise from the combination of: (1) a review bidding process that allows the reviewer access to only the paper title and abstract; (2) authors who write paper titles and abstracts that bear little resemblance to their work. As a consequence of this mismatch, the unsuspecting reviewer may, on occasion, volunteer for a 47 page appendix of freshly minted mathematical notation, ruining their weekend and forcing them to miss a movie they really wanted to see. Of course, the fact that they actively bid on the paper and were therefore *responsible for its assignment* ensures that they feel too guilty to abandon the review. The proof of why this is problematic is left as an exercise for the reader.

Consistency. The grand 2014 NeurIPS review experiment (Lawrence & Cortes, 2015) provides some insight into the consistency of the peer review process. When a paper was assigned to two independent review committees, about 57% of the papers accepted by the first committee were rejected by the second one and vice versa (Price, 2014). While these numbers provide a great deal of hope for anyone submitting rushed work to future editions of the conference, it is perhaps nevertheless worth observing that it brings some downsides. For one thing, it places great emphasis on the role of registering at the right time to get a lucky paper ID. This, in turn, leads to a great deal of effort on the part of the researcher, who must then determine whether a given ID (for example 5738³) is indeed, a lucky number, or whether they are best served by re-registering. A similar phe-

²See Sec. A.2 in the appendix for historical conditions under which a peerage would pass to a female heir.

³Thankfully, numerology is on hand to supply an answer. “5738: You are a step away from the brink that separates big money from lawlessness. Take care, because by taking this step, you will forever cut off your ways to retreat. Unless it is too late.” (numeroscop.net, 2020)

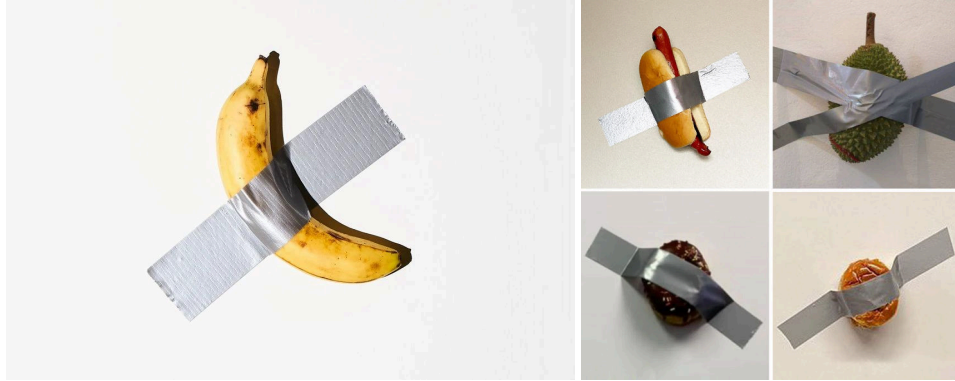

Figure 1: **(Left)** The state-of-the-art according to Cattelan et al. (2020), **(Right)** Some marginal improvements by various authors, with questionable added artistic and nutritional value (as measured in calories and milligrams of potassium).⁴

nomenon is observed in large-scale deep learning experiments, which generally consist of evaluating several random initialisations, a job that is made harder by confounders such as hyper-parameters or architectural choices.

By examining the points above, we derive the key following principle for review process design. *Human involvement—particularly that of elderly hereditary peers—should be minimised in the modern scientific review process.* In this work, we focus on a particular instantiation of this principle, State-Of-the-Art Reviewing (SOAR), and its mechanisms for addressing these weaknesses.

The remainder of the work is structured as follows. In Sec. 2, we review related work; in Sec. 3, we describe SOAR, our bullet-proof idea for automatic reviewing; in Sec. 4 we develop a practical implementation of the SOAR framework, suitable for popular consumption. Finally, in Sec. 5, we conclude with our findings and justification for why we anticipate swift community adoption.

2 RELATED WORK

2.1 INTEREST IN THE STATE-OF-THE-ART

Since the discovery of art (Blombos Cave Engravings, ca. 70000 BC) there has been a rising interest in this form of expression, and consequently, the state thereof. From the Medici family of Florence to theatre buff King James I, much effort has been dedicated to patronage of the arts, and much prestige associated with acquiring the latest advances. Pope Julius II was keen to raise the papal state of the art to new heights, namely the ceiling, enlisting the help of renaissance main man Michelangelo. The score of Sistine remains competitive in chapel-based benchmarks, and Michelangelo became a testudine martial artist (with the help of his three equally-talented brothers) (Eastman & Laird, 1984).

From early on, the importance of adding depth was appreciated (Studies on perspective, Brunelleschi, 1415), which continues to this day (He et al., 2016). Recently, the critically acclaimed work of Crowley & Zisserman (2014) illustrated how the state-of-the-art can be used to assess the state of art, calling into question the relevance of both hyphens and definite articles in modern computer vision research. Of least relevance to our work, Fig. 1 depicts state-of-the-art developments in the art world.

⁴Photo credits: (left): NYT-Photography (2019) (top-centre): Noennig (2019), (top-right): Durian (2019), (bottom-center): Tampa-Police-Department (2019), (bottom-right): Popeyes (2019)

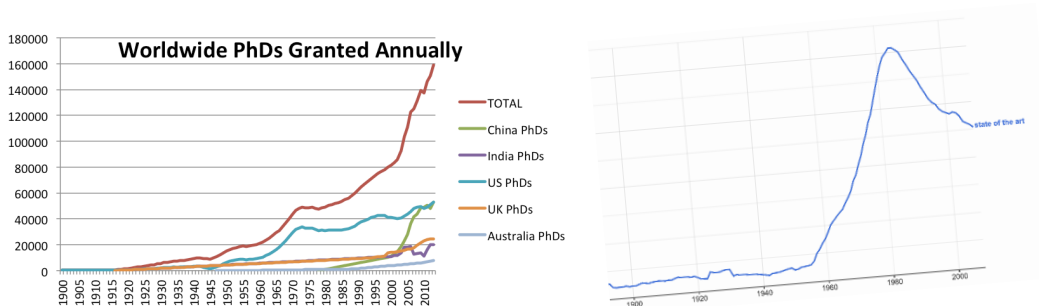

Figure 2: **(Left)** The number of PhDs granted annually exhibits exponential growth (figure reproduced from Gastfriend (2015)), **(Right)** Google retrieved ngram counts of “State of the Art” over the past 200 years of literature. Note that even when the axes are rotated slightly, it remains difficult to preserve an upwards trend. This evidence suggests that either PhDs are becoming exponentially less productive than their predecessors or that the existing reviewing system does not provide sufficient incentivise to use the term “state-of-the-art” in modern manuscripts. Our proposal directly addresses the latter.

2.2 LITERATURE REVIEW

The Grapes of Wrath. In this classic portrayal of the American Dust Bowl, Steinbeck captures the extremes of human despair and oppression against a backdrop of rural American life in all its grittiness. A masterpiece. ★★★★★

Flyer for (redacted) startup, left on a table at NeurIPS 2019 next to a bowl of tortillas. Hastily put together in PowerPoint and printed in draft-mode amid the death throes of an ageing HP printer, this call for “dedicated hackers with an appetite for Moonshots, ramen noodles and the promise of stock options” comes across slightly desperate. ★★

3 METHOD

Science is often distinguished from other domains of human culture by its progressive nature: in contrast to art, religion, philosophy, morality, and politics, there exist clear standards or normative criteria for identifying improvements and advances in science.

Stanford Encyclopedia of Philosophy

In Sec. 1, we identified three key weaknesses in the peer review process: (1) inability to scale; (2) slow runtime and (3) inconsistent results. In the following, we describe the SOAR review scheme which seeks to resolve each of these shortcomings, and does so at minimal cost to the taxpayer or ad-funded research lab, enabling the purchase of more GPUs, nap-pods and airpods.

3.1 STATE-OF-THE-ART REVIEWING (SOAR)

It is well known is that the quality of a scientific work can be judged along three axes: *efficacy*, *significance* and *novelty*. Our key insight is that each of these factors can be measured automatically.

Assessing efficacy. Efficacy is best assessed by determining if the proposed method achieves a new SotA (State-of-the-Art). Thankfully, from an implementation perspective, the authors can be relied upon to state this repeatedly in the text. Thus, rather than parsing results table formats (an error-prone process involving bold fonts and asterisks), we simply word count the occurrences of “state-of-the-art” (case insensitive) in the text. It stands to reason that a higher SotA count is preferable.

Moreover, such an approach avoids the embarrassment of realising that one cannot remember what kind of statistical significance test should be applied since all SotA is significant.

Assessing significance. Significance is measured by efficacy. Thus, the efficacy term is weighted twice in the formula.

Assessing novelty. The assessment of novelty requires close familiarity with prior art and an appreciation for the relative significance of ideas. We make the key observation that the individuals best placed to make this judgement are the author themselves since they have likely read at least one of the works cited in the bibliography. We further assume that they will convey this judgement by using the word “novel” throughout the document in direct proportion to the perceived novelty of the work.

With the strategies defined above, we are now in a position to define the SOAR score as follows.

$$\text{SOAR Score} \triangleq \sqrt[3]{S_{\text{SotA}} \cdot S_{\text{SotA}} \cdot S_{\text{novelty}}} / 10. \quad (1)$$

Here S_{SotA} and S_{novelty} represent the total occurrences in the manuscript of the terms “state-of-the-art” and “novel”, respectively. In both cases, we exclude the related work section (it is important to avoid assigning SotA/novelty credit to the paper under review simply because they cite SotA/novel work). A geometric mean is used to trade-off each factor, but note that a paper must be both SotA and novel to achieve a positive SOAR score. Lastly, we attach a suffix string “/10” to every SOAR score. This plays no role in the computation of the score.

Note that several factors are *not* assessed: vague concepts like “mathematical proofs” and “insights” should be used sparingly in the manuscript and are assigned no weight in the review process. If the proof or insight was useful, the authors should use it to improve their numbers. SotA or it didn’t happen.

A key advantage of the SOAR formula is that it renders explicit the relationship between the key scientific objective (namely, more State-of-the-Art results) and the score. This lies in stark contrast to peer review, which leaves the author unsure what to optimise. Consider the findings of Fig. 2: we observe that although the number of PhDs granted worldwide continues to grow steadily, usage of the term “State-of-the-Art” peaked in the mid 1980’s. Thus, under peer review, many PhD research hours are invested every year performing work that is simply not on the cutting edge of science. This issue is directly addressed by measuring the worthiness of papers by their state-of-the-artness rather than the prettiness of figures, affiliation of authors or explanation of methods.

With an appropriately increased focus on SotA we can also apply a filter to conference submissions to immediately reduce the number of papers to be accepted. With top conferences taking tens of thousands of submissions each typically requiring three or more reviewers to dedicate considerable time to perform each review, the time savings over an academic career could be readily combined to a long sabbatical, a holiday to sunny Crete, or an extra paper submission every couple of weeks.

4 IMPLEMENTATION

In this section, we outline several implementations of SOAR and showcase a use case.

4.1 SOFTWARE IMPLEMENTATION AND COMPLEXITY ANALYSIS

We implement the SOAR algorithm by breaking the submission into word tokens and passing them through a Python 3.7.2 `collections.Counter` object. We then need a handful of floating-point operations to produce the scalar component of Eqn. 1, together with a string formatting call and a concatenation with the “/10”. The complexity of the overall algorithm is judged reasonable.

Cornell University We gratefully acknowledge support from the Simons Foundation and member institutions.

arXiv.org > cs > arXiv:1907.

Search... All fields Search

Help | Advanced Search

Computer Science > Computer Vision and Pattern Recognition

In defense of revisiting Adapting Adaptations: Are convolutions convolutional enough?

SOAR Score: 7/10

Recommendation: You should probably read this

Novel Neville

Submitted on 31 Jul 2019

In recent years, the humble convolution has drawn praise from friends and foes alike for its enviable equivariance, parameter sharing and strong theoretical connection to Joseph Fourier. But is the convolution "convolutional" enough? This question forms the basis of the current work, in which we highlight scenarios in which one does not simply "convolve" a standard convolutional operator, willy-nilly, with all desired inputs.

Download:

- PDF
- Other formats (license)

Current browse context: cs.CV

< prev | next > new | recent | 1907

Change to browse by: cs

Figure 3: **Proposed arXiv-integration:** The arXiv server is an invaluable resource that has played a critical role in the dissemination of scientific knowledge. Nevertheless, a key shortcoming of the current implementation is that it is *unopinionated*, and offers little guidance in whether to invest time in reading each article. The SOAR plugin takes a different approach: summarising the scientific value of the work as an easily digestible score (out of ten) and offering a direct read/don't read recommendation, saving the reader valuable time. Future iterations will focus on removing the next bottleneck, the time-consuming "reading" stage.

4.2 WETWARE IMPLEMENTATION AND COMPLEXITY ANALYSIS

In the absence of available silicon, SOAR scoring can also be performed by hand by an attentive graduate student (GS) with a pencil and a strong tolerance to boredom. Much of the complexity here lies in convincing the GS that it's a good use of time. Initial trials have not proved promising.

4.3 ARXIV INTEGRATION

We apply the SOAR scoring software implementation to the content of arXiv papers as a convenient Opera browser plugin. The effect of the plugin can be seen in Fig. 3: it provides a high-quality review of the work in question. Beyond the benefits of scalability, speed and consistency, this tool offers a direct "read/don't read" recommendation, thereby saving the reader valuable time which can otherwise be re-invested into rejecting reviewer invitations emails to compound its savings effect. We hope that this *pre-review for pre-prints* model will be of great utility to the research community.

5 CONCLUSION

In this work, we have introduced SOAR, a plug-and-play replacement for peer review. By striking an appropriate balance between pragmatism and our lofty goals, we anticipate near-instantaneous community adoption. In future work, we intend to further optimise our implementation of SOAR (from 2 LoC to potentially 1 or 0 LoC, in a ludic exercise of code golf). Other avenues of future research include peer-to-peer ego-limiting protocols and Tourette-optimal author feedback mechanisms.

REFERENCES

- Ishāq bin Ali al Rohawi. *Adab al-tabib* (practical ethics of the physician). CE 854--931.
- Maurizio Cattelan, a tar-covered seagull, and a very strange trip to the local 7-Eleven. Comedian. Art Basel Miami Beach, 2020. (presumably also visible while not under the influence of psychotropic substances).
- Elliot J Crowley and Andrew Zisserman. The state of the art: Object retrieval in paintings using discriminative regions. 2014.
- 99 Old Trees Durian. Durian tape to white wall, 2019. URL <https://www.facebook.com/99oldtrees/posts/2575690792538528:0>. [Online; accessed 27-March-2020].
- Kevin Eastman and Peter Laird. *Teenage Mutant Ninja Turtles*. Mirage Studios, 1984.

- Eric Gastfriend. 90% of all the scientists that ever lived are alive today, 2015. URL <https://futureoflife.org/2015/11/05/90-of-all-the-scientists-that-ever-lived-are-alive-today/?cn-reloaded=1>. [Online; accessed 27-March-2020].
- Kaiming He, Xiangyu Zhang, Shaoqing Ren, and Jian Sun. Deep residual learning for image recognition. In *Proceedings of the IEEE conference on computer vision and pattern recognition*, pp. 770–778, 2016.
- Neil Lawrence and Corinna Cortes. Examining the repeatability of peer review, 2015. URL [http://inverseprobability.com/talks/slides/nips_radiant15.slides.html#/.](http://inverseprobability.com/talks/slides/nips_radiant15.slides.html#/) [Online; accessed 27-March-2020].
- Jordyn Noennig. Banana duct-taped to the wall is art. but how about sausage taped to the wall because, wisconsin, 2019. URL <https://eu.jsonline.com/story/entertainment/2019/12/10/banana-duct-taped-wall-sparks-vanguard-milwaukees-hot-dog-wall/4384303002/>. [Online; accessed 27-March-2020].
- numeroscop.net. On 5738, 2020. URL https://numeroscop.net/numerology_number_meanings/four_digit_numbers/number_5738.html. [Online; accessed 27-March-2020].
- NYT-Photography. The 120,000bananawinsartbasel, 2019. URL. [Online; accessed 27-March-2020].
- Popeyes. Chicken taped to wall, 2019. URL <https://twitter.com/popeyeschicken/status/1203140095005605888>. [Online; accessed 27-March-2020].
- Eric Price. The nips experiment, 2014. URL <http://blog.mrtz.org/2014/12/15/the-nips-experiment.html>. [Online; accessed 27-March-2020].
- Ray Spier. The history of the peer-review process. *TRENDS in Biotechnology*, 20(8):357–358, 2002.
- Tampa-Police-Department. Sgt. donut, 2019. URL <https://www.facebook.com/TampaPD/posts/3297203563685153>. [Online; accessed 27-March-2020].
- Wikipedia contributors. Hereditary peer — Wikipedia, the free encyclopedia, 2020. URL https://en.wikipedia.org/w/index.php?title=Hereditary_peer&oldid=946076588. [Online; accessed 27-March-2020].

A APPENDIX

In the sections that follow, we provide additional details that were carefully omitted from the main paper.

A.1 TITLE PRONUNCIATION

In common with prior works, we hope that the arguments put forward in this paper will spark useful discussion amongst the community. Where appropriate, we encourage the reader to use the official title pronunciation guide in Fig. 4.

A.2 INHERITANCE OF PEERAGES

One historical challenge with the expansion of the UK peerage system has been something of a pre-occupation with preventing the passage of peerages to women. We note that this has grave implications for the ability to scale peer review. Consider the progressive rules for inheritance under Henry IV of England (Wikipedia contributors, 2020), which were as follows:

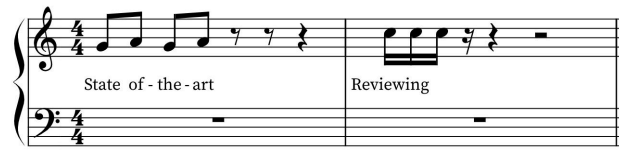

Figure 4: Official Title Pronunciation Guide (gustoso).

“If a man held a peerage, his son would succeed to it; if he had no children, his brother would succeed. If he had a single daughter, his son-in-law would inherit the family lands, and usually the same peerage; more complex cases were decided depending on circumstances. Customs changed with time; earldoms were the first to be hereditary, and three different rules can be traced for the case of an Earl who left no sons and several married daughters. In the 13th century, the husband of the eldest daughter inherited the earldom automatically; in the 15th century, the earldom reverted to the Crown, who might re-grant it (often to the eldest son-in-law); in the 17th century, it would not be inherited by anybody unless all but one of the daughters died and left no descendants, in which case the remaining daughter (or her heir) would inherit.”

Note that by avoiding the necessity of a direct bloodline between peers, SOAR neatly sidesteps this scalability concern, further underlining its viability as a practical alternative to traditional peer review.

A.3 NEW INSIGHTS: A MEMORYLESS MODEL FOR SCIENTIFIC PROGRESS

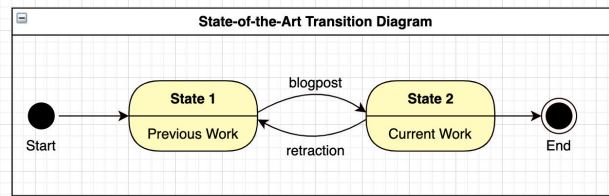

Figure 5: By introducing a State-of-the-Art state transition diagram, we show how the progression of research can be modelled as a memoryless automaton.

Beyond time savings for reviewers, we note here that the SOAR score further provides insights into the scientific method itself, yielding time savings for authors too. To illustrate this, we provide a state transition diagram in Fig. 5 which models the evolution of research progress. Importantly, this model guarantees a Markov-optimal approach to research: a researcher must only ever read the paper which represents the current State-of-the-Art to make further progress.

SIGBOVIK

- 3** **A thorough investigation of the degree to which the COVID-19 pandemic has enabled subpar-quality papers to make it into the proceedings of SIGBOVIK, by reducing the supply of authors willing to invest the necessary effort to produce high-quality papers**

Shalin Shah

Keywords: COVID-19, SIGBOVIK, lazy, quality, sadness, big Oof

- 4** **Is this the longest Chess game?**

Dr. Tom Murphy VII Ph.D.

Keywords: chess, chesses, chessing, G. K. Chesterton

- 5** **Optimizing the SIGBOVIK 2018 speedrun**

leo60228

Keywords: speedrun, SIGBOVIK, pathfinding, DFS, Rust

- 6** **Retraction of a boring follow-up paper to “Which ITG stepcharts are turniest?” titled, “Which ITG stepcharts are crossoveriest and/or footswitchiest?”**

Ben Blum

Keywords: groove, in, retraction, the

A Thorough Investigation of the Degree to which the COVID-19 Pandemic has Enabled Subpar-Quality Papers to Make it into the Proceedings of SIGBOVIK, by Reducing the Supply of Authors Willing to Invest the Necessary Effort to Produce High-Quality Papers

Shalin Shah

Carnegie Mellon University

April 1, 2020

Abstract:

Based on the inclusion of this paper in the proceedings of SIGBOVIK 2020, we find that the COVID-19 pandemic has in fact enabled subpar-quality papers to make their way into the proceedings of SIGBOVIK, through a drastic reduction in the supply of authors willing to invest the necessary effort to produce high-quality papers.

Introduction:

Y'all know what COVID-19 is.

Methods and Materials:

You're looking at the materials. Note that, in order to emphasize the subpar quality of this paper, we have opted to use extremely lazy Microsoft-Word default formatting, rather than LaTeX. Also, we have restricted the contents of this paper to a single page, to highlight its lack of substance. Meanwhile, our method was to simply submit this paper to SIGBOVIK 2020 and see what happened.

Results:

As evidenced by the fact that you're currently reading this in the SIGBOVIK 2020 proceedings, this paper successfully made it into the SIGBOVIK 2020 proceedings.

Discussion:

The results indicate that SIGBOVIK 2020's standards of quality have indeed fallen significantly relative to 2019, presumably due to the COVID-19 pandemic decreasing the supply of authors willing to invest the necessary effort to produce high-quality paper submissions.

Conclusions:

In conclusion, COVID-19 sucks.

References:

n/a



CONFIDENTIAL COMMITTEE MATERIALS

SIGBOVIK'20 3-Blind Paper Review

Paper 36: A thorough investigation of the degree to which the COVID-19 pandemic has enabled subpar-quality papers to make it into the proceedings of SIGBOVIK, by reducing the supply of authors willing to invest the necessary effort to produce high-quality papers

Reviewer: Exponentiator

Rating: Better and better every day, by leaps and bounds and leaping leaps and bounding bounds

Confidence: Those guys have faith, why shouldn't I?

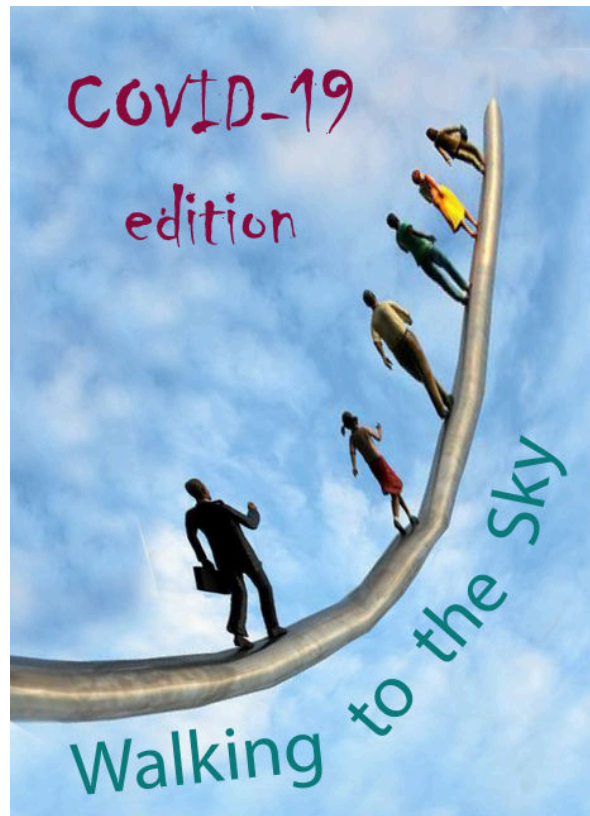

Is this the longest Chess game?

Dr. Tom Murphy VII Ph.D.*

1 April 2020

1 Introduction

In my experience, most chess games end in a few moves. If you want to play a lot of chess moves, you just play a lot of chess games. Still, there are games that seem to go on foreverrrrrrrrr. Perhaps the players are trying to *lull each other into a false sense of security while waiting for the moment to strike*, or perhaps they are stalling in a game of *Chess to the Death*.

Although many people “know how to play” chess, almost nobody fully understands the rules of chess, most authoritatively given by FIDE [1]. (See for example Figure 1 for a minor chess scandal that erupted in 2019 over an obscure corner case in the rules.) Several of these “deep cuts” have to do with game-ending conditions that were introduced to avoid interminable games.

Many chess moves are reversible (e.g. moving the knight forward and back to its starting position [4]), so informal games of chess could last forever with the players repeating a short cycle. In AD 1561, Ruy López added the “fifty-move rule” to prevent infinite games.¹ This rule (detailed below) ensures that irreversible moves are regularly played, and so the game always makes progress towards an end state. Another rule, “threefold repetition” also guarantees termination as a sort of backup plan (either of these rules would suffice on its own).

So, chess is formally a finite game. This is good for computer scientists, since it means that chess has a trivial $O(1)$ optimal solution. This allows us to move onto other important questions, like: What is the longest chess game? In this paper I show how to compute such a game, and then gratuitously present all of its 17,697 moves. Even if you are a chess expert (“chexpert”), I bet you will be surprised at some of the corner cases in the rules that are involved.

Speaking of rules, let’s first detail the three main rules that limit the length of the game. These rules cause the game to end in a draw (tie) when certain conditions are met.

1.1 The seventy-five move rule

The “fifty-move rule,” [8] as it is usually known, requires that an irreversible move is played at a minimum pace. For the sake of this rule, irreversible moves are considered captures and pawn moves,² including promotion and *en passant* (which is also a capturing move) but not the movement of a previously promoted piece. Specifically [1]:

9.3. The game is drawn, upon a correct claim by the player having the move, if:

- he writes his move on his scoresheet and declares to the arbiter his intention to make this move, which shall result in the last 50 moves having been made by each player without the movement of any pawn and without any capture, or
- the last 50 consecutive moves have been made by each player without the movement of any pawn and without any capture.

Note that what is provided here is the option for a player to *claim* a draw (and the two provisions essentially allow either player to claim the draw at the moment of the 50th move). If neither player is interested in a draw, either because they think their position is still winning, or are just trying to create the longest ever chess game, the game legally continues. That’s why what is actually relevant for this paper is provision 9.6, which defines a draw:

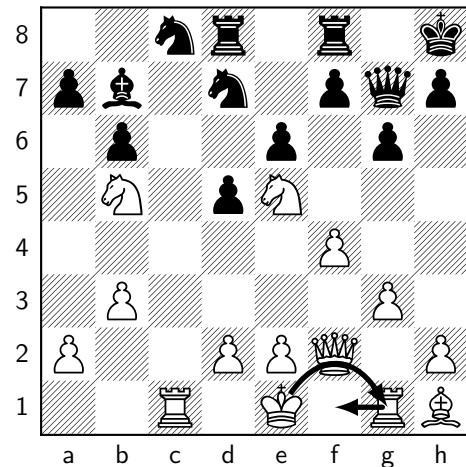

Figure 1: (*Nepomniachtchi – So, 2019.*) White to move during a speed Chess960 (aka “Fischer Random”) tournament. In this variant, the pieces start in different positions, but castling rules are such that the king and rook end up on the same squares that they would in normal chess. As a result, it is possible for the king or rook to not move during castling, or for the destination square for the king to already be occupied by the rook. Attempting to castle in the position depicted, grandmaster Ian Nepomniachtchi first touched the rook to move it out of the way. However, piece-touching rules require that when castling, the player first moves the king (and “Each move must be played with one hand only”); but how? The rook is occupying g1! One commenter suggested tossing the king into the air, then sliding the rook to f1 while the king is airborne, and then watching the king land dead center on its target. The arbiter required Nepo to make a rook move instead, but this was later appealed, and the game replayed.

*Copyright © 2020 the Regents of the Wikiplia Foundation. Appears in SIGBOVIK 2020 with the `ShortMoveString` of the Association for Computational Heresy; *IEEEEE!* press, Verlag-Verlag volume no. 0x40-2A. ☐17,697

¹This rule only applied to games started after its introduction, so it is possible that some pre-1561 games are still in progress and may never end.
²Other irreversible moves include: Castling, moving a piece so as to lose castling rights, and declining to capture *en passant* (such capture must be made immediately, so if the option is not taken, it cannot be regained). The fifty-move rule could be soundly expanded to include these, but, that’s just like, not the rule, man.

9.6. If one or both of the following occur(s) then the game is drawn:

... 9.6.2. any series of at least 75 moves have been made by each player without the movement of any pawn and without any capture. If the last move resulted in check-mate, that shall take precedence.

Draws after 75 moves (per player, so really 150 moves) are compulsory.

Interestingly (at least as interesting as anything in this dubious affair) it is known that some otherwise winning endgame positions require more than 50 moves to execute (Figure 2). The rules of chess have at various times allowed for longer timers in such known situations, but were later simplified to the fixed 50 (and 75) move limit.

1.2 Fivefold repetition

The 75-move rule is rarely applied in practice, but its counterpart, “threefold repetition” [9] is often the cause of draws in modern chess. This rule states that if the same position appears three times, the players can claim a draw:

9.2.2. Positions are considered the same if and only if the same player has the move, pieces of the same kind and colour occupy the same squares and the possible moves of all the pieces of both players are the same. [...]

Like the 75-move rule, this rule has an optional version (upon three repetitions) and a mandatory one in 9.6:

[The game is a draw if ...]

9.6.1. the same position has appeared, as in 9.2.2, at least five times.

Fascinatingly (at least as fascinating as anything in this questionable undertaking), this rule used to require *consecutive* repetition of moves. However, there exist infinite sequences of moves with no consecutive n -fold repetition. For example, in the starting position, white and black can move either of their knights out and back. Let **0** be ♖c3 ♜c6 ♗b1 ♞b8 (queenside knights move, returning to the starting position) and **1** be ♗f3 ♞f6 ♘g1 ♟g8 (kingside). Now the Prouhet–Thue–Morse sequence [7] 0110100110010110...³ can be executed. This infinite sequence is cube-free (does not contain SSS for any non-empty string S) [6], and therefore never violates the consecutive threefold repetition rule [2].

Many implementations of chess ignore these rules or treat them incorrectly. Implementation of the seventy-five move rule simply requires a count of how many moves have transpired since a pawn move or capture, but programs typically do not force a draw after 75 moves. Repetition requires more work, since the program must keep track of each of the states reached since the last irreversible move. There are also some corner cases, such as ambiguity as to whether the starting position has “appeared” before the first move [4]. The ubiquitous FEN notation for describing chess positions does not even include any information about states previously reached.

³Let s_0 be the string “0”, then s_i is $s_{i-1}\bar{s}_{i-1}$ where $\bar{0} = 1$ and $\bar{1} = 0$.

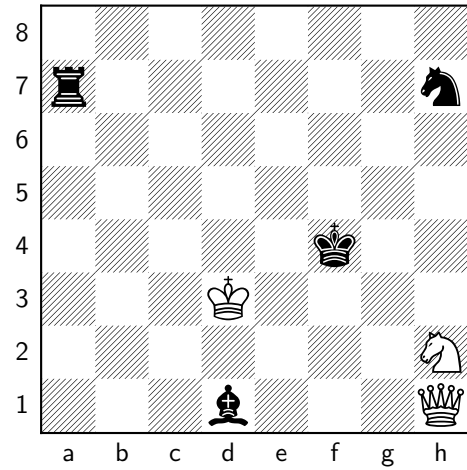

Figure 2: Black to move and mate in 545 moves (!). The position was found (by Zakharov and Makhnichev [10]) while building an endgame tablebase of all possible 7-piece positions. Of course, the game ends prematurely in a draw because of the 75-move rule.

1.3 Dead position

The informal version of this rule (“insufficient material”) states that if neither side has enough pieces to mate the opponent (for example, a king and bishop can never mate a bare king) then the game is drawn. Again, the formal rule is more subtle:

5.2.2. The game is drawn when a position has arisen in which neither player can checkmate the opponent’s king with any series of legal moves. The game is said to end in a ‘dead position’. This immediately ends the game. . .

This clearly includes the well-known material-based cases like king and knight vs. king, but it also surprisingly includes many other specific positions, especially those with forced captures (Figure 3).

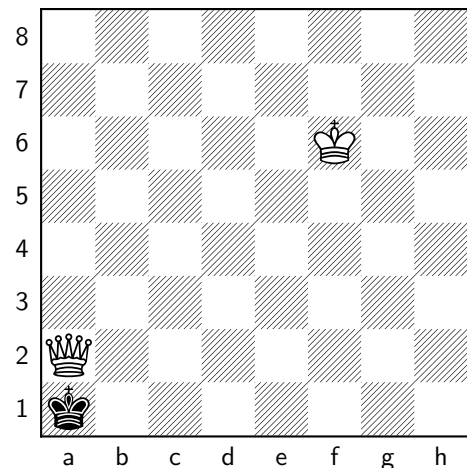

Figure 3: Black to move and draw in 0 (!). Most players and even chexperts believe that the only legal move is Kxa2, and that the game then ends in a draw with “insufficient material.” However, this game is *already over*. Since neither black nor white can win via any series of legal moves, by rule 5.2.2 the game immediately ends in a ‘dead position’. (Although see Section 1.3.1 for possible ambiguity in this rule.)

The insufficient material rule is curious in that it requires non-trivial computation to implement. In order to know whether the position is a draw, an implementation needs to be able to decide whether or not a series of moves that results in checkmate exists. Note that this is not nearly as bad as normal game tree search because the two sides can collaborate to produce the mate (it is not a $\exists\forall\exists\forall\dots$ but rather $\exists\exists\exists\exists\dots$). Still, such “helpmates” can still be quite deep (dozens of moves) and are interesting enough to be a common source of chess puzzles. Proving the non-existence of a helpmate can be very difficult indeed (Figure 4).⁴

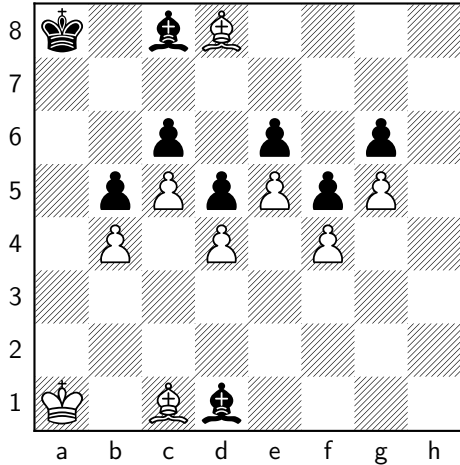

Figure 4: Thinking of implementing the rules of chess? To be correct, you’ll need your program to be able to deduce that no helpmates are possible in this position and thus the game is over. Stockfish rates this as +0.4 for white, even searching to depth 92. (Position is due to user `supercat` on Chess StackExchange.)

1.3.1 Ambiguity

Moreover, this rule contains some ambiguity. The phrase “any series of legal moves” is usually taken to mean something like, “the players alternate legal moves and follow most of the normal rules of chess.” In my opinion it is hard to justify an interpretation like this.

First, the rules specifically define “legal move”, with 3.10.1 saying “A move is *legal* when all the relevant requirements of Articles 3.1 – 3.9 have been fulfilled.” These requirements describe the movement of each piece as you are familiar (e.g. 3.3 “The rook may move to any square along the file or the rank on which it stands.”). They also disallow capturing one’s own pieces, or moving when in check. However, they allow as legal some moves that would otherwise be prohibited, like capturing the opponent’s king (this is excluded by 1.4.1, outside the definition of “legal”). Capturing the opponent’s king is generally not useful for demonstrating that checkmate is possible (Figure 5), so this is mostly a curiosity.

Second, what is a “series” of legal moves? It seems completely consistent to allow the white player to make several legal moves in a row, for example. The rules about alternating moves are again outside the definition of “legal move” and “series” is never defined.

We could instead interpret “any series of legal moves” as “taking the entirety of the rules of chess, any continuation of the game that ends in checkmate for either player.” I like this better, although it creates its own subtle issues. For example, should the position

⁴Perhaps an enterprising reader can prove that for generalized chess, it is NP-hard to decide whether the game has ended due to this rule?

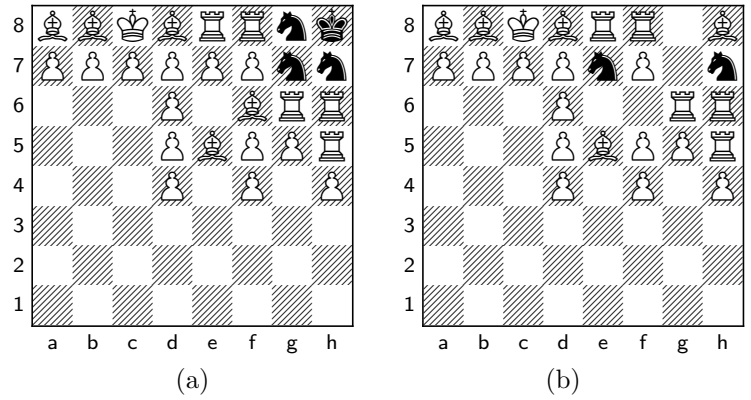

Figure 5: In this contrived and impossible position (a), white has many easy paths to mate. All of black’s pieces are pinned. There is also a “series of legal moves” where black mates white: $\text{♜xg7++} \text{ ♝xh8??} \text{ ♞xe7++}$. Capturing the king (by moving twice in a row) is a “legal move” (despite not being allowed by other rules), and doing so unpins black’s knight to deliver a smothered mate (b). Of course, abuse of this dubious technical possibility doesn’t change the status of the position, since we already have a mating sequence by white.

be considered dead if there is a checkmating sequence, but it requires entering a fivefold repetition or exhaustion of the 75-move rule? If so, this would end the game prematurely, and so it has implications for the longest possible game (Section 2.1). Even more esoterically, this interpretation causes the rule to be self-referential: A sequence must also be allowed by the rule being defined. A normal person would take the “least fixed point” (in the Kripke sense [3]) of this self-referential definition (fewest positions are drawn). But it is also consistent to interpret it *maximally*—in which case the longest chess game is zero moves!

For completeness, note that there are other routes to a draw (stalemate, draw offers) which we can ignore; it is easy to avoid these situations when generating the longest game.

2 Generating the longest game

It is generally not hard to avoid repeating positions, so the main obstacle we’ll face is the 75-move rule. Let’s call an irreversible move that resets the 75-move counter a *critical move*; this is a pawn move or capturing move (or both). The structure of the game will be a series of critical moves (I will call these “critical” moves) with a maximal sequence of pointless reversible moves in between them. If we execute the maximum number of critical moves and make 149 moves (just shy of triggering the compulsory version of the 75-move rule) between them, then this will be fairly easily seen as a maximal game.

In fact, for most positions, it is easy to waste 149 moves and return to the exact same position. So, the strategy for generating the longest game can mostly be broken into two tasks: Make a game with a maximum number of critical moves (it can also contain other moves) and then pad that game out to maximum-length excursions in between its critical moves.⁵

⁵The first phase was constructed by hand. Software for inserting excursions and checking the result is available at: sf.net/p/tom7misc/svn/HEAD/tree/trunk/chess/longest.cc

2.1 Maximal critical moves

Critical moves are pawn moves and captures. There are 16 pawns, each of which has 6 squares to move into before promoting, so this is 16×6 critical moves. There are 14 capturable pieces, plus the 16 pawns (they can be captured after promoting); capturing them nets an additional $16 + 14$ critical moves for a total of 126. Each critical move can be made after a maximum of $75 + 74$ reversible moves, giving $(75 + 74 + 1) \times 126 = 18900$ moves. The final move would capture the last piece, yielding a draw due to the remaining kings being insufficient material (“dead position”). This is our starting upper bound.

We will not quite be able to use the entire critical move budget. If pawns only move forward in single steps, they will eventually get blocked by the opposing pawn on the same file. Pawns can move diagonally off their starting file only by capturing. We have plenty of capturing to do anyway, so this is no problem. With four captures per side, the pawns can be doubled, with a clear route to promotion, like in Figure 6.

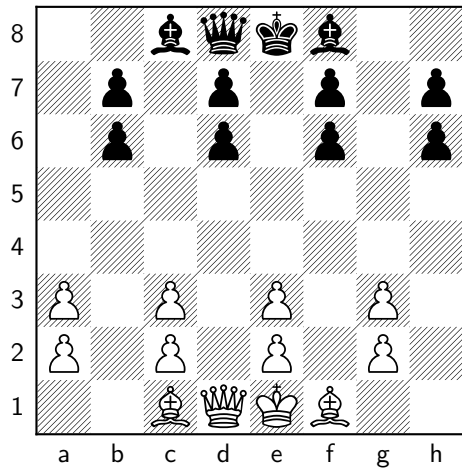

Figure 6: One way to clear the promotion routes for all pawns with eight captures.

However, each of these captures is *both* a pawn move *and* a capturing move. This means that we lose $4 + 4$ critical moves off our total budget. $150 \times (126 - 8) = 17700$ is the new upper bound.

Parity. If a critical move (such as a pawn move) is made by white, then the first non-critical move is made by black. The players alternate these pointless moves until black has made 75 and white 74. Now it is white’s move, and white must make a critical move or the game ends due to the 75-move rule. If instead we wanted black to make the next critical move, this would happen after black has made 74 and white 74 non-critical moves. Any time this happens we lose one move against the upper bound. So, we want to minimize the number of times we switch which player is making the critical moves. Obviously we must switch at least once, because both black and white must make critical moves. This reduces the upper bound to 17699.

Starting condition. The first critical move should be made by black. The starting position (with white to move) is analogous to the situation just described, as if black has just made a critical move, and it’s white’s turn. White will play 75 reversible moves,

black plays 74, and the 150th move is black making the first critical move.

Note that white is quite constrained during this beginning phase, as pawn moves are critical moves and must be avoided. Only the white knights can escape the back rank. When we try to insert 149 pointless moves, we’ll only be able to move the knights and rooks, and doing this 75 times must leave e.g. one of the knights on an opposite-colored square.⁶ So we have to be a little careful about the position in which we make black’s first critical move.

Since white can only free their two knights, these are the only pieces that can be captured by black pawns. So it will not be possible for black to double four sets of their pawns as in Figure 6. This would require white to have a phase of critical moves to free pieces to capture, then black again to finish doubling pawns, then white again to promote its freed pawns. Each switch costs one move off the naive max. We can be more efficient with an asymmetric approach.

Black’s first phase of critical moves instead results in this:

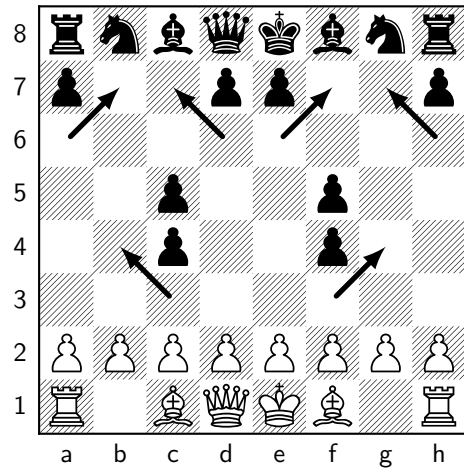

The white b and g pawns have a clear route to promotion. White can free each of the remaining 6 pawns with a single capture. Between this and black’s two pawn captures, this is the optimal 8 pawn moves that are also captures. Since black has plenty of freed pieces, white can promote all of their pawns during their own phase of critical moves, resulting in:

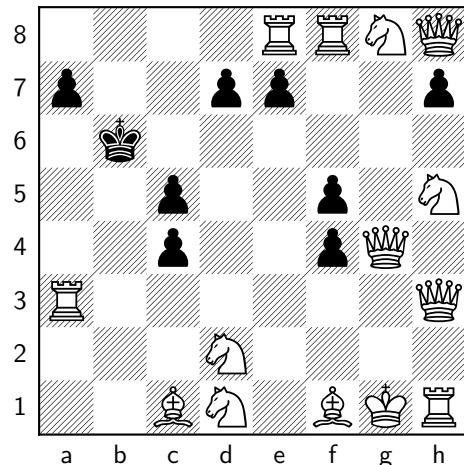

Now black can promote all of its pawns and capture white’s pieces. We actually leave the white queen; this turns out to be essential:

⁶Knight moves always change the color of the knight’s square, and same for rook moves constrained to the a1/b1 or g1/h1 squares.

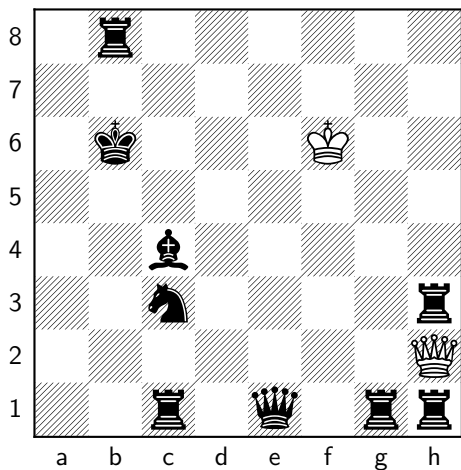

Finally, white captures all of black's pieces, and mates the black king:

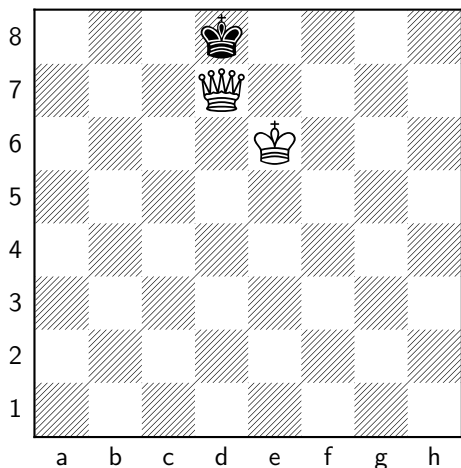

Since we switch which color is making critical moves a total of three times, we must come shy of the naïve maximum of 17,700 moves by three. This gives us an upper bound of 17,697 for this approach, which we will be able to achieve.

Ending condition. The way this game ends is subtle for several reasons. First, note that we left the white queen on the board and used it for mate. It is required that white be the one mating for parity reasons, similar to the reason black must make the first critical move. Since white makes critical moves in the last phase, black leads on non-critical moves; at the moment white makes the checkmating move, black has made 75 non-critical moves, and white 74. White's 75th move mates.

But doesn't this trigger the 75-move rule? No, this rule (9.6.2; Section 1.1) has a special exception for checkmate: "If the last move resulted in checkmate, that shall take precedence." Essentially, we can treat checkmate as a type of critical move.

Why not capture the white queen too? This would be a critical move, but once two kings remain, the game ends immediately in a draw. So there is no length advantage here over checkmate. In fact, attempting to capture may *shorten* the game: Consider the position in Figure 3 where black is *forced* to capture the queen. This game is over prior to the capture, so this is shorter than the checkmating sequence! Even if the king had an escape square, it is arguable (Section 1.3.1) that the game is over in any case: There is no "series of legal moves" that leads to mate. Either the king captures the queen (and then clearly no mate is possible with just the two kings) or the king escapes, but in doing so plays the 75th non-critical move, and triggers a draw by the 75-move rule.

The most foolproof way to ensure that mate is always possible is for the game itself to end in mate. This sidesteps any ambiguity

about the way the 75-move condition should be interpreted, as well.

2.2 Inserting excursions

The game described in Section 2.1 has 118 critical moves in 289 total moves. There is some inefficiency between the critical moves, but this doesn't matter since we are trying to generate a long game anyway. In fact, the next step will be to add *as much inefficiency as possible* in between the critical moves.

Each "critical section," which is the series of moves ending in a critical move, can be treated independently. If black ends the section with a critical move, then we want 75 + 74 non-critical moves to be played, and then black's critical move. For white, of course, 74 + 75. There are many ways we could try to make these 149 moves; we don't even have to use the moves that are already there as long as we end up in the right position to make the critical move. But a simple approach suffices.

For each critical section, we loop over all of the positions encountered, and attempt inserting excursions that return us to the same position but waste moves. There are two types of excursions we try: Even excursions (each player makes two moves) and odd (each player makes three moves).

Even excursions. This four move sequence moves two pieces of X_1 and X_2 of opposite colors. X_1 moves from s_1 to d_1 then X_2 from s_2 to d_2 , then X_1 moves from d_1 back to s_1 , and X_2 from d_2 back to s_2 . Easy. Any piece can perform this maneuver other than pawns (which would be critical moves anyway) as long as there are legal squares (considering check, etc.). All of s_1 , d_1 , s_2 , d_2 must be distinct. No shorter excursions are possible.

Odd excursions. This is the straightforward extension to three squares ($s_i \rightarrow m_i \rightarrow d_i \rightarrow s_i$), for a six-move sequence. The squares for each piece must be distinct but it is possible for e.g. m_2 to equal s_1 . Knights cannot perform this trick; each move changes the color of the square the knight sits on, which causes a contradiction with a cycle of length three. All other pieces can do it with sufficient room. The king, for example, can move horizontally, then diagonally, then vertically back to its starting square.

Note that odd excursions are not possible early in the game (prior to white moving any pawns), because even when the knights are free, the rooks only have two squares (and thus the same color parity argument applies as knights). Some opportunity can be created by having a black knight capture one of white's bishops. Fortunately, we do not need any odd excursions at this point in the game.

We find excursions by just looping over possible moves that satisfy the criteria, prioritizing odd excursions if the target (divided by two) is odd. In order to avoid triggering the fivefold repetition rule, we also keep track of all of the positions encountered, and never enter a position more than two times. (Here we avoid even threefold repetition.) It is not necessary to look beyond the critical section, because critical moves make it impossible to return to a prior position.

This process is not at all guaranteed to work; it may fail to fill the critical section. Indeed, as discussed in Section 2.1, we must have at least one move of slack whenever we switch from a critical move by one player to the other. In practice this approach succeeds readily, and manages to waste 149 moves in each critical section of the input game, save for the three times that parity requires one move of slack. The full game is uselessly included in a very tiny font in Section 4.

3 Reader's guide

The paper demonstrates a game with three “switches” of which side is making critical moves; each costs a move against the naïve maximum due to parity. We clearly need at least one switch (both sides must make critical moves), but is it possible to do it with only two? If not, can this lower bound be proved?

The game given is believed to be maximal, as measured in the number of moves. But, other metrics exist. For example, the letter g is slightly wider than f, so moving ♖g3 is *typographically* longer than ♜f1. PGN format itself can be stretched by making moves that need to be disambiguated (♜ff7 means “move the ♜ on the f file to f7” (not “the giant sword from Final Fantasy 7”, as many believe)) or checking the opponent’s king for a bonus +. Some moves are longer in terms of distance traveled; moving the queen or bishop between opposite corners is $\sqrt{2} \times 7$ squares! What is the longest game according to these or other metrics?

In *Chess*, it is impossible to capture your own pieces. How does this limitation apply to your own life?

In many games of *Chess*, the black and white pieces are found to disagree. What does this say about society?

How do you feel about the ending of the game? Is it disappointing that the result is not symmetric (i.e. a draw), or elegant that it demonstrates its own avoidance of the “dead position” rule? Was it what you expected?

The character called ♚ often plays an important role in the story. How would you describe her personality? How does she develop over the course of the game?

Is this the longest Chess game? is the author’s sixth paper about chess for SIGBOVIK, but it is widely believed that nobody wants to read this kind of thing. What is wrong with him?

4 A longest game

There are jillions of possible games that satisfy the description above and reach 17,697 moves; here is one of them.⁷ Critical moves are marked with **[bold]**. Note that in the standard PGN format for listing games, move numbers are “full moves” consisting of a move by white and then black, whereas we use “move” in this paper to mean “half-move”; an individual move by one of the players. Thus the game ends during full move 8,849, one half of 17,697.

1. ♔a3 ♚f6 2. ♔c4 ♚g4 3. ♔a5 ♚e3 4. ♔b3 ♚a6 5. ♔c5 ♚f5 6. ♔e6 ♔d4 7. ♔c5 ♚e6 8. ♔b3 ♚b8 9. ♔c5 ♚f4 10. ♔a6 ♚h3 11. ♔c5 ♚a6 12. ♔b3 ♚c5 13. ♔f3 ♚a6 14. ♔c5 ♚g1 15. ♔g5 ♚h3 16. ♔e4 ♚e1 17. ♔d4 ♚b8 18. ♔g3 ♚c6 19. ♔c5 ♚e5 20. ♔f5 ♚h3 21. ♔e6 ♚g1 22. ♔c5 ♚g4 23. ♔g3 ♚e5 24. ♔c4 ♚c6 25. ♔c5 ♚h3 26. ♔a4 ♚g1 27. ♔f5 ♚b8 28. ♔g3 ♚h3 29. ♔c5 ♚g1 30. ♔a5 ♚a6 31. ♔a4 ♚h3 32. ♔a5 ♚f4 33. ♔g5 ♚h3 34. ♔b3 ♚g1 35. ♔c5 ♚b4 36. ♔f3 ♚a6 37. ♔e5 ♚h3 38. ♔f3 ♚b4 39. ♔b3 ♚a6 40. ♔a5 ♚c5 41. ♔b3 ♚g5 42. ♔g1 ♚h3 43. ♔a5 ♚a6 44. ♔b3 ♚b4 45. ♔c5 ♚a6 46. ♔a4 ♚b8 47. ♔c5 ♚g5 48. ♔a6 ♚h3 49. ♔b4 ♚f4 50. ♔a6 ♚g6 51. ♔c5 ♚f4 52. ♔b3 ♚c5 53. ♔c5 ♚a6 54. ♔b3 ♚d4 55. ♔c5 ♚b4 56. ♔e6 ♚a6 57. ♔f4 ♚f5 58. ♔e6 ♚h4 59. ♔c5 ♚f5 60. ♔a4 ♚e3 61. ♔c5 ♚a6 62. ♔b3 ♚c3 63. ♔h3 ♚b8 64. ♔g1 ♚f5 65. ♔a5 ♚e3 66. ♔c6 ♚g4 67. ♔a5 ♚c6 68. ♔c4 ♚b8 69. ♔d5 ♚f6 70. ♔g1 ♚a6 71. ♔a5 ♚b7 72. ♔f3 ♚g8 73. ♔g1 ♚a6 74. ♔b1 ♚h8 75. ♔a4 ♚b7 76. ♔e5 ♚a6 77. ♔c4 ♚b6 78. ♔c3 ♚h5 79. ♔c5 ♚f4 80. ♔c4 ♚b7 81. ♔a5 ♚h5 82. ♔c4 ♚a3 83. ♔a5 ♚c6 84. ♔b1 ♚c8 85. ♔b7 ♚b5 86. ♔a5 ♚a6 87. ♔b7 ♚f6 88. ♔d8 ♚c6 89. ♔b7 ♚a5 90. ♔c3 ♚b3 91. ♔a4 ♚b8 92. ♔c3 ♚g8 93. ♔a5 ♚c8 94. ♔d5 ♚d3 95. ♔b4 ♚h6 96. ♔a6 ♚g8 97. ♔b4 ♚b7 98. ♔d5 ♚c8 99. ♔e3 ♚a6 100. ♔d5 ♚d8 101. ♔c5 ♚c3 102. ♔c6 ♚b8 103. ♔a5 ♚f6 104. ♔b7 ♚g8 105. ♔a4 ♚f6 106. ♔a5 ♚c8 107. ♔d4 ♚d4 108. ♔c3 ♚b3 109. ♔b1 ♚a5 110. ♔c3 ♚c6 111. ♔b1 ♚e4 112. ♔d5 ♚f6 113. ♔e6 ♚b8 114. ♔d8 ♚d3 115. ♔b7 ♚a6 116. ♔c5 ♚h5 117. ♔b7 ♚f4 118. ♔a5 ♚h5 119. ♔c6 ♚b5 120. ♔a5 ♚c4 121. ♔b7 ♚b5 122. ♔c6 ♚c6 123. ♔b1 ♚a6 124. ♔a5 ♚b8 125. ♔a5 ♚d8 126. ♔b1 ♚f6 127. ♔c3 ♚h5 128. ♔b7 ♚a4 129. ♔a5 ♚f5 130. ♔c4 ♚a4 131. ♔a4 ♚b7 132. ♔c3 ♚g3 133. ♔a5 ♚h5 134. ♔b3 ♚f4 135. ♔a5 ♚c6 136. ♔c4 ♚b7 137. ♔c3 ♚a6 138. ♔d4 ♚h5 139. ♔a5 ♚b7 140. ♔c1 ♚a6 141. ♔b5 ♚f6 142. ♔c3 ♚a5 143. ♔c4 ♚f6 144. ♔a3 ♚g8 145. ♔b1 ♚c8 146. ♔e5 ♚d8 147. ♔c3 ♚c8 148. ♔b1 ♚f6 149. ♔f3 ♚g8 150. ♔c3 **[g6]** 151. ♔g5 ♚b7 152. ♔c4 ♚h6 153. ♔c5 ♚f3 154. ♔c4 ♚c6 155. ♔c3 ♚d5 156. ♔a4 ♚e5 157. ♔e6 ♚f8 158. ♔c3 ♚h6 159. ♔c5 ♚c6 160. ♔b5 ♚c3 161. ♔a6 ♚a4 162. ♔b4 ♚a5 163. ♔a6 ♚g4 164. ♔f3 ♚c6 165. ♔e4 ♚b3 166. ♔b4 ♚c4 167. ♔g5 ♚d3 168. ♔f3 ♚g5 169. ♔d5 ♚b8 170. ♔g1 ♚b5 171. ♔f3 ♚d3 172. ♔d5 ♚b6 173. ♔d5 ♚c4 174. ♔b4 ♚d3 175. ♔g5 ♚g4 176. ♔f3 ♚c4 177. ♔g5 ♚b8 178. ♔e4 ♚d8 179. ♔c5 ♚b3 180. ♔e4 ♚d4 181. ♔a6 ♚c6 182. ♔g3 ♚a4 183. ♔e4 ♚g7 184. ♔c3 ♚f8 185. ♔b5 ♚c6 186. ♔c3 ♚b3 187. ♔b5 ♚a4 188. ♔b8 ♚h6 189. ♔a6 ♚b3 190. ♔b4 ♚a4 191. ♔d3 ♚c6 192. ♔b4 ♚b8 193. ♔a6 ♚c6 194. ♔a3 ♚b3 195. ♔b5 ♚b8 196. ♔c5 ♚c6 197. ♔e6 ♚d5 198. ♔c5 ♚f5 199. ♔c5 ♚h6 200. ♔b1 ♚c5 201. ♔c3 ♚f5 202. ♔e6 ♚b6 203. ♔e4 ♚g8 204. ♔c3 ♚a4 205. ♔a4 ♚d5 206. ♔d4 ♚h6 207. ♔e6 ♚f6 208. ♔g5 ♚g8 209. ♔e4 ♚c6 210. ♔g5 ♚b8 211. ♔c3 ♚d8 212. ♔b5 ♚f3 213. ♔c3 ♚f6 214. ♔c4 ♚g8 215. ♔e6 ♚b8 216. ♔g6 ♚h5 217. ♔c5 ♚f3 218. ♔a4 ♚b7 219. ♔c5 ♚a6 220. ♔c4 ♚b8

221. ♔c5 ♚f8 222. ♔c4 ♚c8 223. ♔c3 ♚h6 224. ♔f3 ♚g8 225. ♔e5 **[g5]** 226. ♔b5 ♚c6 227. ♔a3 ♚a6 228. ♔d3 ♚c8 229. ♔b4 ♚d8 230. ♔c6 ♚b7 231. ♔b5 ♚e4 232. ♔c6 ♚f5 233. ♔b1 ♚h6 234. ♔a3 ♚d3 235. ♔c4 ♚a6 236. ♔b8 ♚c8 237. ♔a5 ♚f5 238. ♔a6 ♚a4 239. ♔b4 ♚b7 240. ♔b7 ♚f6 241. ♔a5 ♚d4 242. ♔c4 ♚a6 243. ♔e5 ♚h3 244. ♔b6 ♚b5 245. ♔a5 ♚h6 246. ♔f3 ♚b7 247. ♔f5 ♚e6 248. ♔f3 ♚d4 249. ♔b3 ♚b6 250. ♔a5 ♚b5 251. ♔e5 ♚a6 252. ♔a6 ♚f8 253. ♔a5 ♚b6 254. ♔c6 ♚f5 255. ♔b4 ♚h3 256. ♔c4 ♚f5 257. ♔d5 ♚b8 258. ♔b4 ♚c6 259. ♔a5 ♚d4 260. ♔b7 ♚c6 261. ♔d3 ♚g4 262. ♔b4 ♚d4 263. ♔a5 ♚f5 264. ♔a8 ♚f8 265. ♔b4 ♚h6 266. ♔a6 ♚c8 267. ♔b8 ♚h6 268. ♔c4 ♚d3 269. ♔a5 ♚a6 270. ♔c4 ♚a5 271. ♔c6 ♚a6 272. ♔d4 ♚c8 273. ♔c6 ♚f5 274. ♔a3 ♚h6 275. ♔a5 ♚f5 276. ♔e6 ♚e4 277. ♔b1 ♚f5 278. ♔a6 ♚g8 279. ♔c6 ♚a4 280. ♔a3 ♚f5 281. ♔b4 ♚e4 282. ♔c6 ♚f3 283. ♔b8 ♚e4 284. ♔b1 ♚b7 285. ♔a6 ♚b6 286. ♔c6 ♚f8 287. ♔c4 ♚a6 288. ♔a4 ♚b7 289. ♔b4 ♚b8 290. ♔d5 ♚c6 291. ♔b4 ♚b8 292. ♔d3 ♚c6 293. ♔e5 ♚d8 294. ♔d3 ♚c8 295. ♔e5 ♚h6 296. ♔b5 ♚f8 297. ♔d4 ♚b8 298. ♔e5 ♚g7 299. ♔c3 ♚f8 300. ♔d5 **[b5]** 301. ♔g6 ♚h6 302. ♔h4 ♚f6 303. ♔f4 ♚b7 304. ♔d5 ♚a6 305. ♔g6 ♚f8 306. ♔c3 ♚d5 307. ♔c4 ♚h6 308. ♔b6 ♚f4 309. ♔f8 ♚c6 310. ♔g6 ♚c5 311. ♔c8 ♚b3 312. ♔f8 ♚a5 313. ♔g6 ♚b6 314. ♔h4 ♚b8 315. ♔b6 ♚f8 316. ♔c8 ♚a6 317. ♔b6 ♚c5 318. ♔c8 ♚h6 319. ♔g6 ♚c6 320. ♔b6 ♚c6 321. ♔c8 ♚b6 322. ♔h4 ♚b8 323. ♔f3 ♚f8 324. ♔h4 ♚c4 325. ♔b6 ♚e5 326. ♔f3 ♚c6 327. ♔h4 ♚g7 328. ♔c8 ♚f8 329. ♔g6 ♚a5 330. ♔h4 ♚c4 331. ♔b6 ♚a5 332. ♔d5 ♚h6 333. ♔b6 ♚a6 334. ♔c8 ♚a5 335. ♔f5 ♚b6 336. ♔h4 ♚g7 337. ♔g6 ♚h6 338. ♔f4 ♚b8 339. ♔g6 ♚b7 340. ♔h8 ♚a5 341. ♔b6 ♚b3 342. ♔c8 ♚b7 343. ♔g6 ♚a6 344. ♔f4 ♚c5 345. ♔g6 ♚b7 346. ♔b6 ♚e5 347. ♔d5 ♚e6 348. ♔b6 ♚c8 349. ♔h8 ♚a6 350. ♔a4 ♚f4 351. ♔b6 ♚b7 352. ♔g6 ♚a6 353. ♔c8 ♚d5 354. ♔e6 ♚c3 355. ♔c4 ♚d5 356. ♔c3 ♚f8 357. ♔c4 ♚f6 358. ♔e3 ♚c8 359. ♔d5 ♚d8 360. ♔b6 ♚h6 361. ♔d5 ♚g4 362. ♔h4 ♚f6 363. ♔f5 ♚b7 364. ♔h4 ♚c6 365. ♔f4 ♚b7 366. ♔f4 ♚b7 366. ♔f4 ♚c6 367. ♔h4 ♚a6 368. ♔d5 ♚b8 369. ♔c3 ♚g8 370. ♔d5 ♚g7 371. ♔d5 ♚h6 372. ♔e3 ♚f8 373. ♔d5 ♚h6 374. ♔e5 ♚g8 375. ♔c4 **[bxc4]** 376. ♔b4 ♚h6 377. ♔c6 ♚g7 378. ♔b4 ♚f8 379. ♔c6 ♚a6 380. ♔b4 ♚g7 381. ♔d3 ♚b7 382. ♔e5 ♚h6 383. ♔c6 ♚b8 384. ♔d8 ♚b4 385. ♔c6 ♚b8 386. ♔a6 ♚d8 387. ♔b3 ♚d5 388. ♔d4 ♚c6 389. ♔f3 ♚a5 390. ♔h4 ♚b3 391. ♔g6 ♚g7 392. ♔f4 ♚c3 393. ♔c6 ♚b4 394. ♔d4 ♚b8 395. ♔e6 ♚a5 396. ♔d8 ♚e4 397. ♔c6 ♚b8 398. ♔b4 ♚d3 399. ♔a6 ♚e5 400. ♔b4 ♚b3 401. ♔d5 ♚e4 402. ♔b4 ♚d8 403. ♔c6 ♚c8 404. ♔d8 ♚b8 405. ♔c6 ♚d5 406. ♔d8 ♚b7 407. ♔b6 ♚b8 408. ♔c5 ♚b4 409. ♔e6 ♚f3 410. ♔d4 ♚d5 411. ♔f3 ♚d8 412. ♔d4 ♚a3 413. ♔e6 ♚a4 414. ♔f8 ♚c3 415. ♔e6 ♚f3 416. ♔f4 ♚d5 417. ♔h3 ♚g7 418. ♔f4 ♚h6 419. ♔g6 ♚g7 420. ♔h4 ♚h6 421. ♔f5 ♚a5 422. ♔h4 ♚c6 423. ♔f3 ♚a5 424. ♔d4 ♚c6 425. ♔b6 ♚b3 426. ♔d4 ♚b7 427. ♔b3 ♚f6 428. ♔a5 ♚g8 429. ♔c6 ♚c8 430. ♔a5 ♚b8 431. ♔c6 ♚a6 432. ♔d8 ♚b7 433. ♔e6 ♚a6 434. ♔d8 ♚g7 435. ♔c6 ♚h6 436. ♔b4 ♚d8 437. ♔c6 ♚c5 438. ♔e5 ♚a6 439. ♔d3 ♚g7 440. ♔e6 ♚c6 441. ♔d3 ♚e5 442. ♔b4 ♚g7 443. ♔c6 ♚f8 444. ♔b4 ♚b8 445. ♔e6 ♚g7 446. ♔b4 ♚h6 447. ♔c6 ♚f8 448. ♔b4 ♚a6 449. ♔d5 ♚c8 450. ♔f4 **[gxf4]** 451. ♔g1 ♚b7 452. ♔h1 ♚h6 453. ♔g1 ♚g5 454. ♔h1 ♚a6 455. ♔g1 ♚h4 456. ♔h1 ♚c6 457. ♔g1 ♚b8 458. ♔h1 ♚a4 459. ♔g1 ♚f6 460. ♔h1 ♚b5 461. ♔h1 ♚e5 462. ♔h1 ♚a5 463. ♔h1 ♚b5 464. ♔h1 ♚g5 465. ♔h1 ♚g6 466. ♔h1 ♚e4 467. ♔g1 ♚c6 468. ♔h1 ♚b5 469. ♔g1 ♚h6 470. ♔h1 ♚h4 471. ♔g1 ♚h5 472. ♔h1 ♚h3 473. ♔g1 ♚b7 474. ♔h1 ♚g3 475. ♔g1 ♚c5 476. ♔h1 ♚b3 477. ♔g1 ♚d6 478. ♔h1 ♚h4 479. ♔g1 ♚e5 480. ♔h1 ♚h6 481. ♔g1 ♚a4 482. ♔h1 ♚h3 483. ♔g1 ♚c6 484. ♔h1 ♚b7 485. ♔h1 ♚g3 486. ♔h1 ♚d8 487. ♔g1 ♚g6 488. ♔h1 ♚g3 489. ♔g1 ♚b7 490. ♔h1 ♚h3 491. ♔g1 ♚d6 492. ♔h1 ♚b5 493. ♔g1 ♚h4 494. ♔h1 ♚c5 495. ♔g1 ♚g5 496. ♔h1 ♚b3 497. ♔g1 ♚g3 498. ♔h1 ♚b7 499. ♔g1 ♚c5 500. ♔h1 ♚e4 501. ♔g1 ♚h3 502. ♔h1 ♚b5 503. ♔g1 ♚h4 504. ♔h1 ♚a6 505. ♔g1 ♚h5 506. ♔h1 ♚g6 507. ♔g1 ♚c6 508. ♔h1 ♚a4 509. ♔g1 ♚f6 510. ♔h1 ♚h5 511. ♔h1 ♚h4 512. ♔h1 ♚a5 513. ♔g1 ♚b7 520. ♔h1 ♚g5 521. ♔g1 ♚b8 522. ♔h1 ♚h6 523. ♔g1 ♚f8 524. ♔h1 ♚c8 525. ♔g1 **[c6]** 526. ♔h1 ♚f6 527. ♔g1 ♚a6 528. ♔h1 ♚h5 529. ♔g1 ♚c7 530. ♔h1 ♚b5 531. ♔g1 ♚a6 532. ♔h1 ♚c8 533. ♔g1 ♚d4 534. ♔h1 ♚g7 535. ♔g1 ♚b5 536. ♔h1 ♚h5 537. ♔g1 ♚f5 538. ♔h1 ♚h3 539. ♔g1 ♚a6 540. ♔h1 ♚d4 541. ♔g1 ♚c8 542. ♔h1 ♚e4 543. ♔h1 ♚a4 544. ♔h1 ♚f5 545. ♔h1 ♚g7 546. ♔h1 ♚e3 547. ♔g1 ♚e5 548. ♔h1 ♚c3 549. ♔h1 ♚g7 550. ♔h1 ♚b5 551. ♔g1 ♚d8 552. ♔h1 ♚b4 553. ♔g1 ♚b3 554. ♔h1 ♚c3 555. ♔g1 ♚c7 556. ♔h1 ♚b8 557. ♔g1 ♚d6 558. ♔h1 ♚f6 559. ♔g1 ♚e6 560. ♔h1 ♚h3 561. ♔g1 ♚g3 562. ♔h1 ♚a4 563. ♔g1 ♚b3 564. ♔h1 ♚h3 565. ♔g1 ♚c6 566. ♔h1 ♚d6 567. ♔g1 ♚c3 568. ♔h1 ♚b8 569. ♔g1 ♚c7 570. ♔h1 ♚d8 571. ♔g1 ♚b4 572. ♔h1 ♚a4 573. ♔g1 ♚c3 574. ♔h1 ♚c8 575. ♔g1 ♚g3 576. ♔h1 ♚f7 577. ♔g1 ♚e5 578. ♔h1 ♚g7 579. ♔g1 ♚e4 580. ♔h1 ♚f8 581. ♔g1 ♚d4 582. ♔h1 ♚b5 583. ♔g1 ♚g3 584. ♔h1 ♚a6 585. ♔g1 ♚d5 586. ♔h1 ♚c8 587. ♔g1 ♚h5 588. ♔h1 ♚d4 589. ♔g1 ♚g7 590. ♔h1 ♚a6 591. ♔g1 ♚h5 592. ♔h1 ♚b5 593. ♔g1 ♚d8 594. ♔h1 ♚c8 595. ♔g1 ♚c7 596. ♔h1 ♚a6 597. ♔g1 ♚f6 598. ♔h1 ♚b8 599. ♔g1 ♚g8 600. ♔h1 **[c5]** 601. ♔g1 ♚a6 602. ♔h1 ♚f6 603. ♔g1 ♚b6 604. ♔h1 ♚g4 605. ♔g1 ♚b8 606. ♔h1 ♚c3 607. ♔g1 ♚c6 608. ♔h1 ♚a6 609. ♔g1 ♚g4 610. ♔h1 ♚c5 611. ♔g1 ♚f6 612. ♔h1 ♚b7 613. ♔g1 ♚b5 614. ♔h1 ♚f3 615. ♔g1 ♚a5 616. ♔h1 ♚c3 617. ♔g1 ♚g6 618. ♔h1 ♚g4 619. ♔g1 ♚d4 620. ♔g1 ♚b7 621. ♔g1 ♚g8 622. ♔h1 ♚e4 623. ♔g1 ♚g7 624. ♔h1 ♚e5 625. ♔g1 ♚c6 626. ♔h1 ♚a4 627. ♔g1 ♚h4 628. ♔h1 ♚b5 629. ♔g1 ♚g3 630. ♔h1 ♚a4 631. ♔g1 ♚g6 632. ♔h1 ♚c6 633. ♔g1 ♚f3 634. ♔h1 ♚g4 635. ♔g1 ♚c6 636. ♔h1 ♚e4 637. ♔g1 ♚g7 638. ♔h1 ♚g4 639. ♔g1 ♚f3 640. ♔h1 ♚e5 641. ♔g1 ♚g6 642. ♔h1 ♚c6 643. ♔g1 ♚a4 644. ♔h1 ♚g3 645. ♔g1 ♚b5 646. ♔h1 ♚g7 647. ♔g1 ♚a4 648. ♔h1 ♚h6 649. ♔g1 ♚c6 650. ♔h1 ♚e4 651. ♔g1 ♚g4 652. ♔h1 ♚g4 653. ♔g1 ♚h6 654. ♔h1 ♚g7 655. ♔g1 ♚d4 656. ♔h1 ♚c3 657. ♔g1 ♚f6 658. ♔h1 ♚e5 659. ♔g1 ♚a5 660. ♔h1 ♚b5 661. ♔g1 ♚b7 662. ♔h1 ♚a6 663. ♔h1 ♚c8 664. ♔h1 ♚f6 665. ♔g1 ♚f4 666. ♔h1 ♚c6 666. ♔h1 ♚c3 667. ♔g1 ♚b6 668. ♔h1 ♚b8 669. ♔g1 ♚g4 670. ♔h1 ♚a6 671. ♔g1 ♚f6 672. ♔h1 ♚d8 673. ♔g1 ♚g8 674. ♔h1 ♚c8 675. ♔g1 **[f6]** 676. ♔h1 ♚h6 677. ♔g1 ♚b7 678. ♔h1 ♚b5 679. ♔g1 ♚b5 680. ♔h1 ♚c6 681. ♔g1 ♚e4 682. ♔h1 ♚g6 683. ♔g1 ♚f5 684. ♔h1 ♚g7 685. ♔g1 ♚h5 686. ♔h1 ♚d5 687. ♔g1 ♚h6 688. ♔h1 ♚g5 689. ♔g1 ♚c6 690. ♔h1 ♚g7 691. ♔g1 ♚e4 692. ♔h1 ♚f5 693. ♔g1 ♚e5 694. ♔h1 ♚d3 695. ♔g1 ♚f8 696. ♔h1 ♚g4 697. ♔g1 ♚c6 698. ♔h1 ♚e6 699. ♔g1 ♚b8 700. ♔h1 ♚g6 701. ♔g1 ♚d6 702. ♔h1 ♚d3 703. ♔g1 ♚e4 704. ♔h1 ♚b6 705. ♔g1 ♚c6 706. ♔h1 ♚c7 707. ♔g1 ♚a5 708. ♔h1 ♚b5 709. ♔g1 ♚d4 710. ♔h1 ♚a4 711. ♔g1 ♚c6 712. ♔h1 ♚b4 713. ♔g1 ♚a4 714. ♔h1 ♚d4 715. ♔h1 ♚c6 716. ♔h1 ♚c6 717. ♔g1 ♚a5 718. ♔h1 ♚b6 719. ♔g1 ♚b6 720. ♔h1 ♚b8 721. ♔g1 ♚d6 722. ♔h1 ♚d3 723. ♔g1 ♚g6 724. ♔h1 ♚e6 725. ♔g1 ♚d3 726. ♔h1 ♚c6 727. ♔g1 ♚g4 728. ♔h1 ♚e5 729. ♔g1 ♚f5 730. ♔h1 ♚g7 731. ♔g1 ♚e4 732. ♔h1 ♚c6 733. ♔g1 ♚g5 734. ♔h1 ♚d5 735. ♔g1 ♚h6 736. ♔h1 ♚b8 737. ♔g1 ♚h5 738. ♔h1 ♚g7 739. ♔g1 ♚b7 740. ♔h1 ♚b5 741. ♔g1 ♚h6 742. ♔h1 ♚g6 743. ♔g1 ♚e4 744. ♔h1 ♚c6 745. ♔g1 ♚b5 746. ♔h1 ♚a5 747. ♔g1 ♚d8 748. ♔h1 ♚c8 749. ♔g1 ♚f8 750. ♔h1 **[f5]** 751. ♔g1 ♚c7 752. ♔h1 ♚h6 753. ♔g1 ♚b7 754. ♔h1 ♚d5 755. ♔g1 ♚a6 756. ♔h1 ♚e5 757. ♔g1 ♚f8 758. ♔h1 ♚c3 759. ♔g1 ♚c3 760. ♔h1 ♚g7 761. ♔g1 ♚b3 762. ♔h1 ♚a4 763. ♔g1 ♚c8 764. ♔h1 ♚d4 765. ♔g1 ♚c3 766. ♔h1 ♚b3 767. ♔g1 ♚b7 768. ♔h1 ♚f3 769. ♔g1 ♚b7 770. ♔g1 ♚b7 771. ♔g1 ♚d8 772. ♔h1 ♚d4 773. ♔g1 ♚d5 774. ♔h1 ♚f7 775. ♔g1 ♚a5 776. ♔h1 ♚b6 777. ♔g1 ♚c7 778. ♔h1 ♚c8 779. ♔g1 ♚c6 780. ♔h1 ♚e6 781. ♔g1 ♚h6 782. ♔h1 ♚d4 783. ♔g1 ♚b7 784. ♔h1 ♚c6 785. ♔g1 ♚c3 786. ♔h1 ♚d5 787. ♔g1 ♚e5 788. ♔h1 ♚c6 789. ♔g1 ♚f7 790. ♔h1 ♚d4 791. ♔g1 ♚b8 792. ♔h1 ♚h6 793. ♔g1 ♚e3 794. ♔h1 ♚c6 795. ♔g1 ♚c6 796. ♔h1 ♚c8 797. ♔g1 ♚c7 798. ♔h1 ♚b6 799. ♔g1 ♚a5 800. ♔h1 ♚d8 801. ♔g1 ♚d5 802. ♔h1 ♚e4 803. ♔g1 ♚f3 804. ♔h1 ♚c8 805. ♔g1 ♚b7 806. ♔h1 ♚b3 807. ♔g1 ♚b7 808. ♔h1 ♚c8 809. ♔g1 ♚a4 810. ♔h1 ♚d4 811. ♔g1 ♚g7 812. ♔h1 ♚a6 813. ♔g1 ♚b3 814. ♔h1 ♚c3 815. ♔g1 ♚f8 816. ♔h1 ♚c3 817. ♔g1 ♚e5 818. ♔h1 ♚h6 819. ♔g1 ♚d5 820. ♔h1 ♚c8 821. ♔g1 ♚b7 822. ♔g1 ♚c7 823. ♔g1 ♚f8 824. ♔h1 ♚d8 825. **[b3]** ♚h6 826. ♔g1 ♚c6 827. ♚a3 ♚b8 828. ♚c1 ♚b6 829. ♚b2 ♚f6 830. ♚d4 ♚c6 831. ♚e5 ♚b5 832. ♚d1 ♚g4 833. ♚b1 ♚b7 834. ♚g7 ♚b4 835. ♚c3 836. ♚h1 ♚h3 837. ♚b1 ♚h4 838. ♚b2 ♚b6 839. ♚g7 ♚d6 840. ♚d1 ♚h6 841. ♚e5 ♚g6 842. ♚c3 ♚g7 843. ♚g1 ♚g3 844. ♚b1 ♚b7 845. ♚g7 ♚d5 846. ♚c3 ♚b7 847. ♚f6 ♚c8 848. ♚c3 ♚f3 849. ♚d1 ♚g3 850. ♚d4 ♚g7 851. ♚c3 ♚b7 852. ♚h1 ♚c8 853. ♚b4 ♚g6 854. ♚c1 ♚b6 855. ♚e5 ♚f6 856. ♚b1 ♚d6 857. ♚b1 ♚d6 858. ♚f4 ♚g6 859. ♚g1 ♚e4 860. ♚d1 ♚a6 861. ♚b1 ♚c8 862. ♚b2 ♚h3 863. ♚g7 ♚b4 864. ♚b2 ♚h3 865. ♚g7 ♚a6 866. ♚c1 ♚b8 867. ♚h6 ♚g3 868. ♚f3 ♚c6 869. ♚g1 ♚g4 870. ♚f4 871. ♚f4 872. ♚f4 873. ♚f4 874. ♚f4 875. ♚f4 876. ♚f4 877. ♚f4 878. ♚f4 879. ♚f4 880. ♚f4 881. ♚f4 882. ♚f4 883. ♚f4 884. ♚f4 885. ♚f4 886. ♚f4 887. ♚f4 888. ♚f4 889. ♚f4 890. ♚f4 891. ♚f4 892. ♚f4 893. ♚f4 894. ♚f4 895. ♚f4 896. ♚f4 897. ♚f4 898. ♚f4 899. ♚f4 900

1049. Hh1 Ab3 1050. [cxb3] Ag7 1051. Ac2 Ah 1052. Ac3 Ag4 1053. Ac2 Af 1054. Ae4
a6 1055. Ac2 Ab 1056. Wb1 Ah 1057. Ab2 Ag 1058. Ac3 Ag7 1059. Ad4 Ag4 1060. Wb2
d8 1061. Hh1 Ah 1062. Hh1 Ah 1063. Ag7 Af 1064. Ag1 Wb4 1065. Wb1 Af3 1066. Wd3
Ah5 1067. Hd5 Ah3 1068. Hh1 Af 1069. Af8 Wb2 1070. Ag7 Ah3 1071. Wc6 Ah5 1072. Wd5
Ac4 1073. Hh1 Af3 1074. Wd3 Ab4 1075. Wd5 Af 1076. Wd3 Ad5 1077. Hh1 Af3 1078. Hh1
Ab7 1079. Hh1 Af 1080. Wb2 Ab7 1081. Wc5 Ah5 1082. Wb2 Ag5 1083. Hh1 Ah 1084. Wb1
Ag4 1085. Wb2 Ah3 1086. Ad4 Ah5 1087. Wc3 Wd8 1088. Wb2 Ac8 1089. Hh1 Ab7 1090. Af6
Ag7 1091. Ad4 Ah6 1092. Hh1 Ab7 1093. Ac5 Wc7 1094. Ad4 Ae5 1095. Wb1 Ag4 1096. Wd1
Ah 1097. Wb1 Af3 1098. Ac3 Ab7 1099. Ac2 Af8 1100. Wb1 Wd6 1101. Ab2 Wc7 1102. Af6
d8 1103. Hh1 Wb8 1104. Ac1 Wd8 1105. Wc4 Ag4 1106. Wb1 Ae8 1107. Ac2 Ab7 1108. Wb2
Ac6 1109. Wc2 Wc8 1110. Wc4 Wd8 1111. Wc5 Ac8 1112. Wc4 Af6 1113. Wc2 Ag4 1114. Ab2
Ag7 1115. Ac1 Af6 1116. Wc3 Ag7 1117. Wc6 Ah 1118. Wc4 Af6 1119. Wc2 Ag7 1120. Ac3 Ag8
1121. Ac1 Ae5 1122. Wd1 Ag7 1123. Hh1 Af8 1124. Hh1 Ab7 1125. [a3] Wb8 1126. Hh1 Af3
1127. Ac2 Ah5 1128. Wd2 Ae5 1129. Hh1 Ad4 1130. Wc2 Wg7 1131. Ac2 Wb6 1132. Hh1 Ag6
1133. Ac2 Ag6 1134. Ad3 Af7 1135. Wc6 Wg6 1136. Ac4 Wg6 1137. Wc6 Wg6 1138. Wc7 Wb6
1139. Ab2 Ag6 1140. Ad4 Ag7 1141. Wc5 Ag6 1142. Wd6 Af7 1143. Wb8+ Wd8 1144. Wc5 Ah5
1151. Wb8+ Wd8 1146. Wb8 Af6 1147. Wd6 Af8 1148. Wc5 Ag7 1149. Hh1 Af7 1150. Hh1 Wb6
1157. Wc8 Af8 1158. Wc7 Ag6 1159. Ab2 Af7 1160. Hh1 Ag8 1161. Hh1 Wb6 1162. Ac1 Af8 1163.
Wc5 Ae6 1164. Wc7 Wb6 1165. Wc5 Wb5 1166. Wc4 Wb6 1167. Wb7 Wb6 1168. Wc4 Ah5 1169.
Wc3 Af7 1170. Wb3 Wb6 1171. Wc3 Ae5 1172. Wc3 Ae6 1173. Wc3 Ae6 1174. Wd3 Ag7 1175.
Wc2 Af8 1176. Ab2 Ah5 1177. Ac1 Ag7 1178. Wd2 Af8 1179. Wb1 Wb6 1180. Wd2 Ag7 1181. Hh1
Wb6 1182. Wc2 Wg7 1183. Wd1 Wd4 1184. Ac2 Wb 1185. Wd2 Af8 1186. Wb2 Wc5 1187. Wd2
Wg7 1188. Hh1 Wb5 1189. Wb1 Wb8 1190. Wd2 Wd8 1191. Wc2 Wb8 1192. Wd3 Af3 1193. Wc2
Ag7 1194. Wd1 Af8 1195. Ab2 Ab7 1196. Ac1 Wd6 1197. Hh1 Wb8 1198. Wc2 Wd8 1199. Wd1
Ac8 1200. [A4] Ac6 1201. Ac3 Wb8 1202. Ac1 Wb4 1203. Ac2 Wb7 1204. Wb2 Wc7 1205. Wc1
Ag7 1206. Aa5 Af3 1207. Wb1 Af7 1208. Wd3 Ad5 1209. Wc3 Ae5 1210. Wf3 Ad8 1211. Wc4
Ac6 1212. Ac3 Ag8 1213. Wc2 Wd6 1214. Wd2 Ae6 1215. Wc2 Af7 1216. Wc4 Ae6 1217. Wb1
Af6 1218. Ad4 Ae6 1219. Wc4 Ae6 1220. Wc6 Ag8 1221. Wc4 Ae6 1222. Wd3 Af6 1223. Wc4
Af7 1224. Wb1 Ae6 1225. Wc2 Wc6 1226. Wb1 Ag4 1227. Ac3 Wc6 1228. Ac5 Ae5 1229. Ac3
Ab8 1230. Wc4 Ae5 1231. Hh1 Af7 1232. Hh1 Wb6 1233. Wc2 Wb7 1234. Wd2 Ag8 1235. Wc2
Wd6 1236. Wc2 Wc7 1237. Wc2 Af7 1238. Wc1 Wb8 1239. Ac2 Ae6 1240. Ac3 Ae6 1241. Aa5
Wd8 1242. Ab4 Ad5 1243. Aa5 Ag8 1244. Wf3 Ad5 1245. Wb4 Af7 1246. Aa5 Wb6 1247. Wg3
Wc7 1248. Hh1 Ag7 1249. Hh1 Ab2 1250. Wf3 Ag7 1251. Wb1 Af3 1252. Wd3 Wb6 1253. Wb1
Ac3 1254. Wc1 Ag7 1255. Ab6 Ae6 1256. Aa5 Wc8 1257. Wb4 Wc7 1258. Hh1 Af8 1259. Wd1
Ac5 1260. Wb2 Ae6 1261. Wc2 Ad8 1262. Wb2 Wc7 1263. Wc2 Wb7 1264. Ac3 Wb8 1265. Ab4
Ag8 1266. Wd1 Ae6 1267. Wb1 Ag8 1268. Wd1 Wb5 1269. Aa3 Wb8 1270. Wb1 Wc8 1271. Wd1
Ag7 1272. Ac1 Af8 1273. Ab2 Ab7 1274. Ac1 Wc6 1275. [a5] Wf6 1276. Wc2 Wb6 1277. Hh1
Ad5 1278. Wd1 Wc7 1279. Aa3 Ah 1280. Wc2 Wg6 1281. Ac1 Wb8 1282. Wd3 Wb8 1283. Wb2
Wd8 1284. Wd2 Ae5 1285. Wb1 Ae6 1286. Wc2 Ae4 1287. Hh1 Ah8 1288. Wc3 Wb8 1289. Wc2
Wb6 1290. Wd2 Ae5 1291. Wc2 Af6 1292. Wb1 Ah5 1293. Wd3 Wb8 1294. Wg3 Wc6 1295. Wg4
Wb8 1296. Wg3 Ad5 1297. Wd3 Ae4 1298. Ac1 Wd5 1299. Aa3 Wb 1299. Wb1 Wb6 1301. Wc2
Af6 1302. Wb1 Ag8 1303. Wc2 Wd4 1304. Ac2 Wd5 1305. Ab2 Wb8 1306. Aa3 Wc8 1307. Wc2
Wb8 1308. Wd1 Ae6 1309. Wc2 Wf6 1310. Wd3 Ag8 1311. Wd4 Wd8 1312. Wd3 Ah 1313. Wc2
Af8 1314. Wd1 Ah 1315. Wc2 Ad3 1316. Hh1 Ag4 1317. Ac3 Ae6 1318. Wc2 Wc8 1319. Wb1
Wd8 1320. Ab2 Ae5 1321. Ad3 Wb6 1322. Wd2 Ag6 1323. Ab2 Ae8 1324. Ac3 Wb8 1325. Wb2
Wd8 1326. Wc3 Wg7 1327. Wc2 Wb6 1328. Wc2 Wg7 1329. Ab2 Ae5 1330. Aa3 Ag4 1331. Wc1
Ah 1332. Hh1 Wg6 1333. Hh1 Ag8 1334. Wc2 Ad5 1335. Wb2 Wb6 1336. Wc2 Wc8 1337. Wd1
Wc7 1338. Ac1 Wg8 1339. Wd1 Ah 1340. Wc2 Wd8 1342. Wd1 Ab7 1343. Wc2
Wc6 1344. Hh1 Wb6 1345. Ab2 Wf6 1346. Ac1 Ae4 1347. Ab2 Ab7 1348. Ab2 Wc6 1349. Ac1 Wd6
1350. [a6] Wb6 1351. Aa3 Wb6 1352. Wc2 Wd5 1353. Ab2 Ae8 1354. Aa3 Wg6 1355. Ac1 Ag8
1356. Wc4 Af6 1357. Wb1 Wg7 1358. Ab2 Wg3 1359. Wd2 Ae5 1360. Ac2 Wb3 1361. Wc2 Ad5
1362. Wd1 Wb4 1363. Wb2 Af6 1364. Wd2 Ag3 1365. Wb1 Wb8 1366. Wb2 Ag4 1367. Wc1 Ae6
1368. Wd1 Ah6 1369. Wb1 Wd6 1370. Wd1 Wg6 1371. Wb1 Af8 1372. Wd1 Ab7 1373. Wc1 Ae8
1374. Wc2 Wg7 1375. Wd1 Wb6 1376. Wd1 Wb8 1377. Wd1 Wb8 1378. Wd1 Wb8 1379. Wd1 Wb8
1380. Wc4 Ag3 1381. Wb1 Ab7 1382. Wd2 Ae8 1383. Ac1 Wb4 1384. Aa3 Ag7 1385. Wd2 Af8
1386. Ac1 Ad5 1387. Wb2 Ab6 1388. Wc2 Ad5 1389. Ad4 Wb3 1390. Ac2 Wb6 1391. Hh1 Wb8
1392. Ac1 Wf6 1393. Wc2 Wg3 1394. Wd2 Ah5 1395. Ab2 Wf6 1396. Wd3 Ae5 1397. Wd2 Ab7
1398. Wb1 Ae8 1399. Hh1 Wg7 1400. Hh1 Wb8 1401. Ac2 Wf7 1402. Ac3 Wg6 1403. Ac1 Wg4
1404. Wc4 Wg6 1405. Wc5 Ag 1406. Wc4 Wf6 1407. Wc2 Af8 1408. Wb2 Wb6 1409. Wc2 Ae5
1410. Ac3 Wd5 1411. Wc3 Wb6 1412. Wc2 Wd4 1413. Ab2 Wd5 1414. Ad4 Ab7 1415. Ab2 Ag7
1416. Ac3 Af8 1417. Hh1 Wg6 1418. Hh1 Wc7 1419. Wd1 Wb6 1420. Wc1 Wd8 1421. Wd1 Ag5
1422. Ac1 Wb7 1423. Ab2 Wg8 1424. Ac1 Wc6 1425. [axb7] Wb6 1426. Ab2 Af7 1427. Ac1 Ag8
1428. Hh1 Wb6 1429. Ab2 Wf6 1430. Ad3 Ag7 1431. Hh1 Wc7 1432. Wb1 Wc8 1433. Wb2 Ae6
1434. Ac1 Wc7 1435. Hh1 Ah6 1436. Ad4 Ag7 1437. Wd1 Wb8 1438. Ac3 Wb8 1439. Ab4 Wd8
1440. Aa5 Af8 1441. Wc2 Wg7 1442. Ac3 Wg3 1443. Wd5 Wd3 1444. Ac3 Wc3 1445. Wc3 Wd3 1446.
Ag7 Ad4 1447. Wc2 Wg7 1448. Wc3 Aa6 1449. Ae5 Wd3 1450. Ag7 Ae3 1451. Ae5 Wc7 1452. Wd5
Ae6 1453. Wc7 Ag3 1454. Wd5 Wc3 1455. Ac3 Wd3 1456. Wd2 Ag3 1457. Aa5 Wf6 1458. Ac3
Wf7 1459. Aa5 Ag7 1460. Wd4 Af8 1461. Ab4 Ag7 1462. Aa3 Wb8 1463. Ab4 Wf6 1464. Ac3 Wf7
1465. Wb4 Ae6 1466. Wd4 Af6 1467. Ae5 Ag7 1468. Ad6 Wc8 1469. Ae5 Ad5 1470. Wd3 Ac7
1471. Wc5 Ah6 1472. Wb1 Wb8 1473. Wb2 Wc8 1474. Wc2 Af8 1475. Wb2 Wd5 1476. Hh1 Ae7
1477. Ad4 Ae6 1478. Ae5 Wg5 1479. Ad4 Wb8 1480. Wb1 Wc8 1481. Af6 Wc7 1482. Ad4 Wf6
1483. Wd1 Wf7 1484. Ac3 Wd8 1485. Ad4 Wf7 1486. Hh1 Wf7 1487. Ab2 Wf6 1488. Ad4 Wb6 1489.
Ab2 Ae4 1490. Ac1 Wg5 1491. Hh1 Wb6 1492. Hh1 Wf7 1493. Hh1 Wc6 1494. Wc1 Wc6 1495. Ag7
Ah 1496. Ab2 Wb6 1497. Ac1 Wd8 1498. Hh1 Ag8 1499. Hh1 Wd6 1500. [b8=N] Wc7 1501.
Wc2 Ag7 1502. Wc5 Ae5 1503. Wb8 Wc6 1504. Ab2 Wf6 1505. Ac1 Ae3 1506. Aa3 Ab4 1507. Ab2
Ah 1508. Ac1 Wc7 1509. Wd8 Wd8 1510. Wc4 Ag4 1511. Wd6 Ah 1512. Wd3 Wb6 1513. Wb3
Aa3 1514. Wd3 Wc8 1515. Wc3 Wd6 1516. Wf3 Wd8 1517. Wb3 Wb6 1518. Wd4 Wf6 1519. Wb3
Wc5 1520. Wd3 Wc6 1521. Wb3 Wc5 1522. Wc3 Wc7 1523. Wb3 Wb4 1524. Wd4 Wb6 1525. Wb8
Ac8 1526. Wd6 Ah5 1527. Wb3 Wb6 1528. Ab2 Wd6 1529. Ac1 Wf7 1530. Wf3 Wc8 1531. Wc3
Ah 1532. Wf3 Wd5 1533. Wc3 Wd6 1534. Wb3 Wf6 1535. Wc3 Wf7 1536. Wd3 Wf6 1537. Wb1 Wb8
1538. Wd3 Wb6 1539. Wb3 Wb8 1540. Wc3 Ag4 1541. Wb3 Wb6 1542. Wd3 Wf6 1543. Wc2 Wd8
1544. Wd3 Ac3 1545. Wf3 Ad4 1546. Aa3 Ag4 1547. Ac1 Wc6 1548. Wb8 Wf6 1549. Wf3 Ah6
1550. Wc3 Wc7 1551. Wf3 Wd6 1552. Wd6 Wf6 1553. Ab2 Wc6 1554. Ac1 Wg8 1555. Ab2 Ac3
1556. Aa3 Ab4 1557. Ac1 Ae3 1558. Hh1 Ae5 1559. Hh1 Wc4 1560. Ab2 Wc6 1561. Ad4 Wd6
1562. Ab2 Ag7 1563. Ac1 Ae5 1564. Aa3 Wc7 1565. Ac1 Wd3 1566. Wc4 Wd6 1567. Hh1 Ag7
1568. Hh1 Ah6 1569. Ac2 Ag7 1570. Wc6 Af8 1571. Wb8 Wb6 1572. Wd1 Wd6 1573. Wc6 Wd8
1574. Wb8 Wc6 1575. [b6] Ah6 1576. Aa3 Ae4 1577. Hh1 Wc3 1578. Ab2 Wc8 1579. Wd6 Wc3
1580. Ac1 Af8 1581. Wb2 Wf7 1582. Wd3 Ae3 1583. Aa5 Wb7 1584. Wb2 Ad4 1585. Wb1 Ae4
1586. Ac3 Wb8 1587. Wc2 Wc8 1588. Wb1 Ah6 1589. Hh1 Ae3 1590. Aa3 Ad4 1591. Hh1 Ae3
1592. Wd6 Ae6 1593. Wc1 Wb8 1594. Wd1 Wc6 1595. Ag7 Wc7 1596. Ac3 Wc6 1597. Aa5 Wf6 1598.
Ac3 Ag8 1599. Hh1 Ah6 1600. Ad4 Wc8 1601. Ac3 Ag4 1602. Hh1 Ah6 1603. Wd2 Ae4 1604. Wd3
Af7 1605. Wd1 Wb6 1606. Ad4 Ad4 1607. Wb4 Wc6 1608. Hh1 Wd4 1609. Wc2 Ae3 1610. Wd4 Wb6
1611. Wc1 Ae4 1612. Ab2 Ad4 1613. Ac3 Wc6 1614. Wc2 Wc8 1615. Wd6 Wc8 1616. Wd4 Wb8
1617. Wd6 Wd5 1618. Wb1 Wd8 1619. Ab2 Wb7 1620. Ac3 Wc8 1621. Aa5 Wb7 1622. Wb8 Wc8
1623. Wd6 Wc3 1624. Wb2 Ae3 1625. Wc1 Ag7 1626. Wb2 Wb8 1627. Wd3 Wb7 1628. Wb4 Wc8
1629. Aa3 Wd3 1630. Ab4 Wc3 1631. Wc1 Wc3 1632. Aa3 Af8 1633. Wb2 Wc3 1634. Wc1 Wc3
1635. Wb8 Ah6 1636. Wc1 Wc3 1637. Wd1 Wc3 1638. Wb8 Wc3 1639. Ac3 Wd8 1640. Ab4 Ae5
1641. Aa3 Ae3 1642. Wb1 Ae4 1643. Wd1 Wc8 1644. Hh1 Wd8 1645. Ab2 Wc6 1646. Aa3 Wc8
1647. Ac1 Wd8 1648. Wc2 Af8 1649. Wb8 Ah6 1650. [b7] Wg6 1651. Wc2 Ag7 1652. Ab2 Wc8
1653. Ae5 Wc6 1654. Wc4 Ah 1655. Wd5 Wd6 1656. Ag7 Ab4 1657. Ab2 Ae6 1658. Ad4 Af6
1659. Wc6 Wb6 1660. Wf1 Ad4 1661. Wc6 Ae4 1662. Wb5 Ae5 1663. Aa4 Ag5 1664. Wb5 Ae2
1665. Wc6 Wb2 1666. Wf6 Wd8 1667. Wc6 Ae2 1668. Ag7 Wb2 1669. Ah6 Ae5 1670. Ag7 Wd8
1671. Wd6 Ae2 1672. Wb8 Ae5 1673. Ad4 Ae2 1674. Ae5 Wb2 1675. Ad4 Ac3 1676. Wf6 Ae4
1677. Wc7 Wc8 1678. Wb8 Ae2 1679. Wd6 Wb2 1680. Wc6 Wb2 1681. Wb8 Ah4 1682. Wb5 Ag5
1683. Ae3 Ae5 1684. Ad4 Ae3 1685. Wd4 Ae4 1686. Wd6 Ah6 1687. Wb6 Wc6 1688. Wb5 Wc8
1689. Ae3 Ae4 1690. Ad4 Ag5 1691. Wb6 Ah6 1692. Wc6 Ah6 1693. Wb8 Ae6 1694. Wc6 Af8
1695. Hh1 Ah6 1696. Wd5 Af8 1697. Wc6 Ah6 1698. Wd3 Wf6 1699. Ab2 Ae4 1700. Wc5 Wd6
1701. Wc5 Wf6 1702. Wd7 Wc8 1703. Wc6 Ah6 1704. Wb8 Af7 1705. Ae5 Wb6 1706. Ae3 Wc6
1707. Ae5 Wf6 1708. Wc6 Wf6 1709. Wd6 Ag7 1710. Ae5 Ag7 1711. Wc2 Ah6 1712. Wc3 Wc6
1713. Wc2 Wd6 1714. Wd2 Wg6 1715. Af6 Wd8 1716. Ab2 Wc7 1717. Ac1 Wd8 1718. Wd4 Af8
1719. Wc2 Ae5 1720. Wd1 Wd8 1721. Aa3 Wd6 1722. Ab2 Ae6 1723. Ac1 Ag4 1724. Wc6 Wb6
1725. [b8=W] Wc3 1726. Wb6 Wd3 1727. Wc5 Wd6 1728. Wb8 Wf6 1729. Wb4 Wc6 1730. Wc6
Wc6 1731. Wb7 Wc7 1732. Wb5 Ae3 1733. Wd5 Ae3 1734. Wb5 Ae6 1735. Ab5 Ae5 1736. Wb4
Ad5 1737. Wd6 Wc7 1738. Wb8 Wc7 1739. Wd5 Ae6 1740. Wd5 Ag7 1741. Wb4 Wb7 1742. Wd2
Wc7 1743. Aa3 Wb6 1744. Wd3 Wc6 1745. Wb3 Ae6 1746. Wd3 Ag7 1747. Wb1 Wb6 1748. Wd1
Wb5 1749. Aa3 Wb6 1750. Wc4 Wc7 1751. Wd5 Ae8 1752. Ac1 Wc7 1753. Wc6 Wb7 1754. Wd5
1755. Wd6 Wb7 1756. Wd6 Wb7 1757. Wd6 Wb7 1758. Wd6 Wb7 1759. Wd6 Wb7 1760. Wd6 Wb7
Ag7 1761. Wd8 Ah6 1762. Wb8 Ae7 1763. Wd6 Wb5 1764. Wb8 Ae7 1765. Wb6 Ae5 1766. Wb8
Ac3 1767. Wb4 Ad5 1768. Wb8 Wc7 1769. Wd6 Ae3 1770. Wb8 Af8 1771. Wb5 Ah6 1772. Wb8
Wc6 1773. Wb5 Ad6 1774. Wc6 Ae6 1775. Ab2 Ae5 1776. Ac1 Ag7 1777. Wb5 Ah6 1778. Aa3 Ag4
1779. Wb5 Ad5 1780. Wb5 Ae5 1781. Wb7 Wc6 1782. Wb5 Wd8 1783. Wb7 Ae3 1784. Wb4 Ag4
1785. Wb6 Wc6 1786. Wb4 Wc8 1787. Wc5 Wg6 1788. Wd5 Wf6 1789. Wb4 Wd6 1790. Wb8 Wf6
1791. Wb5 Wd6 1792. Wc6 Wd3 1793. Wg6 Wc6 1794. Wc6 Wd8 1795. Aa3 Wc3 1796. Ac1 Wf3
1797. Wb8 Wc3 1798. Wg1 Wc6 1799. Hh1 Wf8 1800. [b4] Wc8 1801. Wc8 Ag7 1802. Wb8 Wd4
1803. Wb7 Wf8 1804. Wd5 Ad4 1805. Wd5 Wc6 1806. Wd4 Wb6 1807. Wb5 Wf7 1808. Wg1 Wd6

1809. Wc6 Wb8 1810. Ab2 Wf8 1811. Ac3 Wf6 1812. Wd6 Ae3 1813. Wc6 Wg5 1814. Wc5 Wg7
1815. Ab2 Wg5 1816. Wb8+ Wg7 1817. Wc5 Ae5 1818. Wg8+ Wb6 1819. Wc6 Wg6 1820. Wd5 Wg4
1821. Wd8 Wg6 1822. Wc6 Wg5 1823. Wc6 Wb6 1824. Wd6 Wg5 1825. Ac6 Wf7 1826. Wg8+ Wb6
1827. Wb8 Wg7 1828. Wd3 Wd5 1829. Wd5 Wd3 1830. Wd6 Wd5 1831. Wb5 Wf8 1832. Wb8+ Wf7
1833. Wc6 Wf8 1834. Ac3 Wg7 1835. Ab2 Wf7 1836. Ac3 Ah5 1837. Wc6 Wf6 1838. Wc4 Wd6 1839.
Wc6 Ad4 1840. Wd5 Ae3 1841. Wb5 Ad4 1842. Wc6 Ag4 1843. Wb5 Wf6 1844. Wd5 Wf7 1845. Wc6
Wc8 1846. Wd5 Ae3 1847. Ac1 Ad4 1848. Wb7 Wd8 1849. Wd5 Wb6 1850. Wd5 Wd8 1851. Aa3
Wb6 1852. Ac1 Wf8 1853. Hh1 Wc8 1854. Wb7 Wf8 1855. Aa5 Wb6 1856. Wd4 Wb6 1857. Wc5 Ae6
1858. Wd5 Ae3 1859. Wd1 Ag4 1860. Wc6 Ae4 1861. Wd5 Ah6 1862. Wb7 Ag4 1863. Ab2 Ag7
1864. Ac1 Wf7 1865. Wc6 Wf8 1866. Hh1 Wb8 1867. Hh1 Ae5 1868. Wb5 Ae4 1869. Wb3 Wc6 1870.
Wd1 Wc8 1871. Wc8 Wb8 1872. Wd8 Ah6 1873. Wc8 Wf8 1874. Wb8 Wc8 1875. [b5] Ae5 1876.
Wb6 Wf6 1877. Wc8 Wb8 1878. Wd4 Ag7 1879. Wc8 Ah6 1880. Wb3 Wc4 1881. Wb2 Ag8 1882.
Wb4 Wc7 1883. Wd4 Ae4 1884. Wf6 Wc3 1885. Ab2 Wd3 1886. Ac3 Wd3 1887. Ae4 Wd8 1888.
Wd2 Wb8 1889. Wd8 Wf3 1890. Wf6 Wb3 1891. Ad4 Wg3 1892. Wg7 Wb8 1893. Wd8 Wb3 1894.
Wg1 Wb3 1895. Hh1 Wg6 1896. Wc6 Wg3 1897. Wd5 Wb8 1898. Wc6 Wd3 1899. Wb8 Wb3 1900.
Wc5 Ag4 1901. Wc6 Ah4 1902. Wf6 Wg4 1903. Wd4 Wf3 1904. Wb4 Wd3 1905. Ab2 Wf3 1906. Ad4
Wf3 1907. Wb7 Wd8 1908. Wf6 Wb8 1909. Ae5 Wd8 1910. Wc5 Wc7 1911. Wc6 Wf4 1912. Ac3
Wd4 1913. Wb2 Wd3 1914. Wb4 Wg7 1915. Ab2 Wg4 1916. Wc5 Wc3 1917. Wc6 Ah4 1918. Ac1
Wg4 1919. Wf2 Wc4 1920. Wf6 Wg7 1921. Wd4 Wg4 1922. Wd3 Wc5 1923. Wd4 Ag7 1924. Wd2 Wc
Wb6 1925. Aa5 Wd8 1926. Wc6 Wc6 1927. Wd5 Ae5 1928. Wd6 Wf6 1929. Wd5 Wc6 1930. Wb3 Ae5
1931. Wc3 Wg8 1932. Wd5 Wg5 1933. Wb2 Wf8 1934. Wb2 Ag7 1935. Wb2 Wb6 1936. Wd2 Wd4
1938 1937. Wb4 Ah6 1938. Wc6 Wc6 1939. Wd1 Ae5 1940. Wc2 Wb8 1941. Wd1 Ah5 1942. Wb6
Wf6 1943. Wd5 Ag4 1944. Wc7 Wf7 1945. Wb8 Wc8 1946. Ab2 Ae4 1947. Aa3 Ae6 1948. Ac1
Wf8 1949. Wc5 Wc8 1950. [b6] Wc8 1951. Wd4 Wc7 1952. Wd4 Wf8 1953. Wb8 Wc6 1954. Wb5
Wd6 1955. Wc2 Wd5 1956. Wg7 Wc6 1957. Ab2 Ae5 1958. Wb6 Wg5 1959. Wd1 Wg6 1960. Wb3
Wb8 1961. Wb1 Ah6 1962. Hh1 Wf7 1963. Wf3 Wd6 1964. Wb5 Wd5 1965. Wc2 Wd8 1966. Wd4
Wc8 1967. Wc2 Wc6 1968. Wd4 Ag7 1969. Wf3 Wg8 1970. Wf3 Wc6 1971. Wf3 Wb7 1972. Wb5
Wd8 1973. Wc6 Ah6 1974. Ad4 Wb8 1975. Wd5 Wd8 1976. Wf3 Wd5 1977. Wb5 Wf7 1978. Aa
Wd5 1979. Wd6 Wf7 1980. Wd6 Wc6 1981. Wc2 Wd5 1982. Ac1 Wb8 1983. Wc2 Ae8 1984. Wb1
Wb8 1985. Aa3 Wd6 1986. Ab2 Wc6 1987. Wf3 Wf7 1988. Wc3 Wc8 1989. Wb5 Wb8 1990. Hh1
Wb8 1991. Wc3 Wc8 1992. Wd4 Wc6 1993. Hh1 Wc6 1994. Wc2 Af8 1995. Wb1 Wb8 1996. Wd1
Wb8 1997. Wb8 Wb8 1998. Wd4 Wg3 1999. Wb6 Wd3 2000. Wc2 Wd3 2001. Hh1 Wg6 2002. Hh1
Wf6 2003. Wf7 Wc6 2004. Wd4 Ag4 2005. Wc2 Wc8 2006. Ac1 Wc6 2007. Wd8 Wd5 2008. Wf7
Wd6 2009. Wb8 Ah6 2010. Wd4 Af8 2011. Wd4 Wc7 2012. Hh1 Wf7 2013. Wd4 Wd8 2014. Wb5
Wc6 2015. Wd4 Wc6 2016. Wc5 Wc6 2017. Wf3 Ah6 2018. Wd4 Wc8 2019. Wc6 Wf6 2020. Ab2
Wd8 2021. Ac1 Ag5 2022. Wd1 Ah6 2023. Ab2 Wb8 2024. Wc6 Wf8 2025. [b7] Wf6 2026. Wd6
Ac4 2027. Ab2 Wd5 2028. Wc1 Wc6 2029. Wf6+ Wf8 2030. Wf6+ Af8 2031. Wb3 Ag6 2032. Wb3
Wf7 2033. Wg3 Wc3 2034. Wb3 Wc3 2035. Wg3 Wf3 2036. Wd5 Ah5 2037. Aa3 Wg6 2038. Wf6
Wc3 2039. Wd4 Wc6 2040. Wf3 Wb6 2041. Wc3 Wd6 2042. Wc5 Wc6 2043. Ab4 Wd5 2044. Wf6
Wc5 2045. Wb3 Wc4 2046. Wf3 Wd5 2047. Wc3 Wb6 2048. Wd5 Wf8 2049. Cb6 Wc6 2050. Aa5
Wc3 2051. Wf6 Ah5 2052. Wb3 Wc6 2053. Wc3 Wd6 2054. Aa3 Wc6 2055. Wf6 Wd6 2056. Wb4
Wb6 2057. Wf6 Wc5 2058. Wb3 Wc6 2059. Ac1 Wc6 2060. Aa3 Wc5 2061. Wf6 Ag6 2062. Cb6
Wc3 2063. Hh1 Ag7 2064. Wf3 Af8 2065. Ad4 Wf3 2066. Wf6 Wc6 2067. Wf6 Wf3 2068. Hh1
Wg7 2069. Hh1 Wd3 2070. Ac1 Wf3 2071. Wb4 Wf6 2072. Wb5 Wd5 2073. Cb6 Wf3 2074. Ab2
Wc5 2075. Ac1 Wd3 2076. Wb3 Wc3 2077. Wf3 Wc3 2078. Wb3 Ae4 2079. Wb3 Af6 2080. Wb8
Wd5 2081. Cb6 Wc3 2082. Wb3 Wc5 2083. Wg4 Wg6 2084. Wf3 Ag4 2085. Wb3 Wf6 2086. Wb2
Af4 2087. Wf3 Wc3 2088. Wd1 Wc5 2089. Wd2 Ah6 2090. Wc6 Wf8 2091. Wf6+ Wf8 2092. Wd6
Wc8 2093. Ab2 Wc6 2094. Ac1 Wd8 2095. Ab2 Af6 2096. Ac1 Ah5 2097. Wc5 Ae6 2098. Aa3
Ag4 2099. Ac1 Wc8 2100. [b8=N] Wc8 2101. Aa3 Wb6 2102. Wd6 Wb8 2103. Wc5 Wf8 2104.
Wc4 Wc7 2105. Wc3 Wd6 2106. Wb4 Wc7 2107. Cb2 Wd6 2108. Wf3 Wd4 2109. Wf3 Wc8 2110.
Wd3 Wf6 2111. Wb1 Ag8 2112. Wc1 Wf7 2113. Wf3 Wc8 2114. Wd6 Wf7 2115. Wc3 Ag7 2

4046. d45+ wb5 4047. ab2 wb6 4048. ad2 wa6 4049. ac1 wa5 4050. [e4] xg6 4051. wf6+ wb7 4052. wh8 xg4 4053. hb2 wa2 4054. wf6 xg1 4055. ec2 wa6 4056. we6 xg5 4057. h2 4068 4058. wdg4 wf6 4059. wg5 wf7 4060. wd5+ wb6 4061. wd2 wa3 4062. wd2 wf8 4063. lg2 4063+ 4064. wf2 wf3 4065. ec6 wb3+ 4066. ae2 xg3 4067. fe8 wf6 4068. ec3 h6 4069. wg7 4074 4070. wfh4 xg6 4071. ac1 wg5 4072. ab2 wb6 4073. lg1 h6 4074. lg2 c7 4075. wf2 wb6 4076. wh4 xg3 4077. wh3 wb5 4078. wg5 wb6 4079. fl1 wf6 4080. ec3 wf3 4081. ac2 4083 4082. wg7 wf8 4083. wg5 c7 4084. ec8+ wb6 4085. fl1 wf6+ 4086. ae2 wf3 4087. fl1 wf8 4088. cb8 wf3 4089. wd2 wf3+ 4090. wf2 wa3 4091. wd3 h8 4092. me2 wf8 4093. wd5 wf7 4094. wd2 wa4 4095. hb2 wa3 4096. dd4 wa2 4097. ab2 wb7 4098. wf6+ wb6 4099. we6+ wb7 4100. wg7 wf6 4101. hb5 wa3 4102. wg4 wa2 4103. wd2 xg6 4104. wf5+ wb3 4105. wd1 wa2 4106. xg6 xg5 4107. xg8 xg7 4108. h1 xg5 4109. b4 xg6 4110. ec2 xg4 4111. wf6 xg6 4112. db4 xg1 4113. ec2 xg4 4114. db4 xg3 4115. wh8 xg4 4116. wd2 wa5 4117. wf1 db6 4118. ac1 wa5 4119. wg3 xg6 4120. wf3 wb6 4121. wf6+ wb7 4122. wf8 wb6 4123. wf3 xg6 4124. wf3 wa6 4125. [e5] fl7 4126. wf6 xg7 4127. fe7 xg4 4128. wf2 wb7 4129. wf3 h6 4130. wf4 xg5 4131. ec2 xg6 4132. ec3 xg7 4133. cf7 wa8 4134. wf3 wf7 4135. ad4 wa3+ 4136. xg1 xg6 4137. ec2 xg5 4138. wf6+ wb7+ wa5 4139. wf8 wa8 4140. wf6 h5 4141. ad4 wa3+ wb5 4142. wf8 wa3+ wa5 4143. wf3 wb5 4144. wf1 wd3 4145. cf7 wd6 4146. h3 wb4 4147. h1 wf6 4148. wa6 wd3 4149. wb8 h3 4150. wf6 h5 4151. wf6 xg5 4152. xg4 wa5 4153. wf3 wb5 4154. wf3+ wb4 4155. wa3+ wb5 4156. wf3 wa5 4157. cf6 wa5 4158. wf4 wa6 4159. wf1 wa5 4160. wf1 wb5 4161. wd1 wb6 4162. wf7+ wb5 4163. wf8 wb6 4164. fe2 xg6 4165. wf7 wa5 4166. fl1 wf6 4167. fd3 xg7 4168. fl1 xg8 4169. ad4 xg7 4170. cb4 wb7 4171. fa2 wf6 c4 4172. ae3 wb8 4173. ec1 wa8 4174. fa2 wb5 4175. wh3 wb6 4176. fb4 wb7 4177. fa2 wf6 c4 4178. cf6 wb7 4179. h2 xg6 4180. h2 xg6 4180. ac1 xg6 4182. wf8 wa5 4183. wa6 xg7 4184. cb8 xg6 4185. wf6 xg7 4186. wa6 xg4 4187. cb8 wf8 4188. wf8 wb7 4189. hb5 wa6 4190. wf6 wa4 4191. db4 wa6 4192. wd2 xg7 4193. wd1 xg6 4194. wf8 xg7 4195. ae2 wf7 4196. fl1 wf6 4197. hb5 wa6 4198. wf3 wf6 4199. hb5 wa5 4200. [exf6] wa6 4201. ae2 wa5 4202. wf3 wa4 4203. ae3 wa5 4204. wf3 wb5 4205. wf3 wf8 4206. wf5 wf8 4207. ae2 wf6 wb6 4208. fg7 wf5 4209. ad2 wb7 4210. wf2 wa8 4211. ae3 wb7 4212. wf6 wf4+ 4213. wf2 wf3 4214. hb5 wf3 4215. ad2 wb6 4216. wf6 wf7 4217. wf3 wb7 4218. wf8 wf3 4219. wf7 wf7 wf6 4220. wf8 wf7 4221. wf8 wf6 4222. wf7 wf6 4223. wf8 wf6 4224. wf2 wf6 4225. wf1 wf3 4226. wf2 wf5 4227. wf6 wf6 4228. wf5 wf7 4229. wf6 wf6 4230. fb4 wf3 4231. wf2 wf3+ 4232. wf2 wa8 4233. fg7 wf7 4234. wf8 wa4 4235. wf8 wf6 4236. ae2 wf4+ 4237. fa2 wf5 4238. ae3 wf6 4239. wf5 wf5 4240. ad2 wa8 4241. wf2 wf7 4242. ae2 wf5 4243. wf8 wf7 4244. wf8 wf7 4245. wd1 wf5 4246. fl1 wf6 4247. h1 wf6 4248. ae3 wf5 4249. wf3 wf8 4250. wd1 wf7 4251. hf5 wf8 4252. wf7 wf5 4253. wf8 wf6 4254. ae2 wf8 4255. wf6 wf8 4256. wf5 wf6 4257. wf3 wf8 4258. ad2 wa5 4259. ae3 wa2 4260. wf3 wa5 4261. wd4 wf6 4262. wd1 wa6 4263. wf3 wa5 4264. wf8 wa4 4265. wf8 wa5 4266. ac1 wf6 4267. hf4 wa5 4268. hf1 wf5 4269. wf3 wa5 4270. wf4 wa6 4271. wf3 wa2 4272. ad3 wa5 4273. fl1 wa6 4274. wf7 wa5 4275. [f7] wf3 wa3 4276. wf4 wf3+ 4277. wd2 wf6 4278. wf3 wf5+ 4279. wf4 wd5 4280. wf3 wf6+ 4281. wf6 wf6 4282. wf7 wf6 4283. wf2 wf6+ 4284. wf4 wd5 4285. wf2 wf7 4286. fa8 wa6 4287. wf8 wf6 4288. ad2 wf6 4289. ac1 wf6 4290. wf5 wf6 4291. wf1 wf6 4292. wf6 wa5 4293. wf1 wf6 4294. wf2 wf8 4295. wf4 wf8 4296. wf6 wf7 4297. wf8 wf8 4298. cd5 wf8 4299. ddb4 wf7 4300. wf2 wf8 4301. ad3 wf6 4302. fl1 wf6 c6 4303. wf5 wf6 4304. hf6 wf6 4305. wf8 wf6 4306. wf6 wa5 4307. wf4 wf6 4308. fa2 wf6 4309. wf2 wf6 4310. hf1 wf6 4311. hf5 wf6 4312. wf8 wf6 4313. hf4 wf6 4314. wf6 wf6 4315. wf4 wf6 4316. ab2 wf6 4317. hf3 wf6 4318. fl1 wf6 4319. ac1 wf6 4320. wf1 wf7 4321. hf1 wf8 4322. wf6 wf7 4323. wf4 wf6 4324. hf4 wa8 4325. fb8 wf7 4326. wf3 wf5 4327. hf5 wf6 4328. wf7 wf5 4329. ae2 wf6 4330. fl1 wf6 4331. wf2 wf6 4332. ad3 wf6 4333. hf1 wf6 4334. wf7 wf6 4335. wf8 wf6 4336. wf3 wf6+ 4337. wf6 wd5 4338. wf3 wf5+ 4339. wf4 wf6 4340. wf3 wf6 4341. wd2 wf6 4342. wd1 wf6 4343. wf2 wf6 4344. wf1 wf3 4345. wf3 wa6 4346. wf2 wa6 4347. wf2 wa5 4348. wd1 wa6 4349. wf8 wa5 4350. [f8=R] wf7 4351. ab2 wf7 4352. ac1 wf6 4353. wf8 wf6 4354. lg1 wf6 4355. wf3 wf5 4356. wf6 wf7 4357. wf8 wf6 4358. wd2 wf6 4359. wf6 wf6 4360. wf2 wf6 4361. lg2 wf6 4362. wf6 wf7 wf8 4363. hf3 wf7 4364. wf7 wf7 4365. cd2 wf6 4366. fa8 wf8 4367. hf1 wf7 4368. lg1 wf6 4369. wf8 wf7 4370. wf3 wf6 4371. wd2 wf8 4372. wf3 wf7 4373. ae3 wf7 4374. ac1 wf6 4375. wf7 wf7 4376. fa2 wf8 4377. fb4 wf7 4378. lg2+ wf6 4379. hf1 wf6 4380. lg1 wf7 4381. wf8 wf6 4382. wf3 wf6 4383. wf3 wf7 4384. fl1 wf6 4385. wf1 wf6 4386. wf2 wf5 4387. hf2 wf6 4388. wf3 wf7 4389. wf8 wf6 4390. wf8 wf6 4391. fa2 wf6 4392. db4 wf5 4393. wf5 4393. wf1 wf6 4394. wf5 wf6 4396. db4 wf6 4397. wf8 wf5 4398. fa3 wf6 4399. ac1 wf6 4400. wf3 wf6 4401. hf1 wf6 4402. wf8 wf7 4403. wf8 wf6 4404. wf4 wf6 4405. hf2 wf6 4406. hf1 wf6 4407. wf6 wf7 4408. wf3 wa5+ 4409. fb4 wf5 4410. ac1 wf6 4411. ad2 wf6 4412. ac1 wa6 4413. wf2 wa5 4414. wf6 wa6 4415. wf5 wa5 4416. wf3 wa6 4417. wf3 wa5+ 4418. wf2 wa6 4419. wf2 wa5 4420. wf8 wa3 4421. df1 wa2+ 4422. ad2 wf3 4423. wf2 wa2 4424. wf1 wa3 4425. [fxa3] wf7 4426. wf3 wf6 4427. wa6+ wf7 4428. wf4 wf7 4429. wf4 wf7 4430. wf3 wf7 4431. fb6+ wf7 4432. wf6+ wf7 4433. hf6 wf7 4434. ae3 wf7 4435. wf6 wf6 4436. wf5 wf6+ wf7 4437. wf8 wf7 4438. fa3 wf7 4439. wf2 wf7 4440. wf6 wf7 4441. wf2 wf7 4442. fa1 wf7 4443. wf3 wf7 4444. wf3 wf7 4445. wf6 wf7 4446. hf2 wf6 4447. wf2 wf6 4448. wa8 wa5 4449. wf3 wf5 4450. wf3 wa5 4451. wf8 wf5 4452. wf4 wf6 4453. hf5 wf6 4454. wf6 wa5 4455. wa6+ wf5 4456. hf6+ wa5 4457. wa6+ wf5 4458. wf6 wa5 4459. wf4 wf6 4460. hf5 wa6 4461. hf6+ wa5 4462. hf4 wa6 4463. wf4 wf5 4464. wf3 wa5 4465. wf8 wa5 4466. wf8 wa5 4467. wf3 wa5 4468. wf3 wa5 4469. wa8 wf5 4470. wf1 wf6 4471. wf2 wf7 4472. hf6 wf7 4473. hf6 wf7 4474. wf2 wf3 4475. wf3 wf7 4476. wf3 wf7 4477. fb3 wf7 4478. wf3 wf7 4479. wf3 wf7 4480. ad2 wf7 4481. ac1 wf7 4482. wf6 wf5+ wf7 4483. wf6 wf7 4484. wf4 wf7 4485. wd1 wf7 4486. wf6+ wf7 4487. wf6+ wf7 4488. wa6 wf7 4489. wf4 wf7 4490. wf4 wf7 4491. wf8 wf7 4492. wa5 wf6 4493. wf6+ wf7 4494. wa3 wf6 4495. wf2 wf7 4496. wd1 wf7 4497. wf5 wf7 4498. hf4 wf6 4499. wa3 [f3] 4500. wf5 wf7 4501. wf8 wf6 4502. wf7 wf7 4503. wf3 wf6 4504. wf4 wf7 wf7 4505. wf8+ wf8 4506. wd6+ wf7 4507. wf6 wf6 4508. wf6 wf6 4509. wf3+ wf6 4510. dfb3 wf5 4511. wf2 wf6 4512. wa8 wf5 4513. wf6 wf7 4514. wf4 wf5 4515. wf7 wf6 4516. wf7 wf5 4517. wf5 wf6 4518. wf8+ wf5 4519. wf6 wf6 4520. wf6 wf5 4521. wf6 wf5 4522. wf6 wf5 4523. hf1 wf6 4524. wf2 wf6 4525. wf3 wf5 4526. wf2 wf6 4527. ad3 wf7 4528. wf6 wf6 4529. wf8 wf6 4530. fl1 wf6 4531. wf3 wf5 4532. wf2 wf6 4533. wf1 wf5 4534. ad2 wf6 4535. wd1 wf6 4536. hf1 wf5 4537. wd1 wf6 4538. hf3 wf6 4539. wf4 wf6 4540. wf7 wf5 4541. wf6 wf6 4542. wf8+ wf5 4543. wf7 wf6 4544. wf2 wf5 4545. ad6 wf6 4546. wf7 wf4 4547. wf4 wf6 4548. wf3 wf7 4549. wf3 wf6 4550. wf6 wf5 4551. wf2 wf6 4552. wf3 wf6 4553. wf8 wf6 4554. wf2 wf5 4555. wf3+ wf6 4556. wf3+ wf5 4557. fa2 wf6 4558. wa8 wf7 4559. wf2 wf6 4560. wf6 wf7 4561. wf8+ wf8 4562. fg7+ wf7 4563. wf2 wf6 4564. wf1 wf5 4565. wf3 wf6 4566. wf3 wf7 4567. wf3 wf6 4568. wf8 wf7 4569. hb5 wf6 4570. wf8 wf3 wf6 4571. wf1 wf6 4572. wf8 wf7 4573. wf6 wf6 4574. wf2 [f2] 4575. ec3 wf5 4576. wf3 wf6 4577. wf1 wf6 4578. lg2+ wf6 4579. wf3 wa6 4580. wf2 wf6 4581. wf4 wf6 4582. wf3 wf6 4583. wf1 wf6 4584. hf2 wa6 4585. wf2 wa5 4586. wf2 wf6 4587. wf6 wf6 4588. hf1 wf6 4589. wf2 wa5 4590. wf3 wa6 4591. wf3+ wf6 4592. wf3 wf5 4593. wf1 wf4 4594. wf3 wf5 4595. wf4 wf6 4596. wf1 wf6 4597. wf3 wa4 4598. wf3 wf6 4599. wf3 wf5 4599. wf1 wf4 4600. wa3+ wf6 4601. ec2 wf6 4602. ec2 wf7 4603. wf3 wf6 4604. wf3 wf6 4605. wa3+ wf6 4606. wf2+ wf6 4607. wf1 wa5 4608. wf3 wa4 4609. wf4 wa5 4610. fb3+ wf6 4611. ad2+ wf6 4612. wf2 wf6 4613. wf3 wf6 4614. wf2 wf6 4615. wf1 wf6 4616. wf4 wf6 4617. wf8 wf5 4618. wf8 wf4 4619. wf3 wf6 4620. wd1 wf6 4621. hf4 wf6 4622. wf4 wf6 4623. wf8 wf6 4624. ec2 wf6 4625. wf3 wa5 4626. wf2 wf6 4627. wf4 wf6 4628. wf3 wa5 4629. wf4 wf6 4630. wf2 wf6 4631. lg2 wf7 4632. wf8 wf6 4633. wd5+ wa6 4634. ec3 wf5 4635. hf1 wa6 4636. wa3+ wf6 4637. wf3 wf6 4638. ad2+ wf6 4639. fl1 wf6 4640. wf4 wf6 4641. wf4 wf6 4642. wf3 wf6 4643. hf6 wf6 4644. wf8 wa4 4645. wf3 wf5 4646. wf4 wf6 4647. ad2 wf6 4648. wf1 wf6 4649. ad3 [f1=R] 4650. wf3 wf6 4651. wf3 wf2+ 4652. wf3 wf6 4653. wf8+ wf7 4654. wf8 wa6 4655. wa8 wf6 4656. wf1 wf6 4657. wf3 wf6 4658. wf3 wf6 4659. ac2 wf6 4660. ad3 wf6 4661. wf6+ wf6 4662. wf7+ wf6 4663. wf7 wf6 4664. wf1 wf2 4665. hf4 wf6 4666. wf8+ wf6 4667. wa8 wf2 4668. wf5 wf6 4669. ad2 wf6 4670. wf7 wf7 4671. wf3 wa6 4672. ac1 wf6 4673. wf3 wf6 4674. ac1 wf6 4675. wf3 wf2 4676. wf3 wf2 4677. hf4 wf2 4678. wf3 wf2 4679. wf3 wf6 4680. wf8+ wf6 4681. wf8 wf6 4682. ab2 wf2 4683. ac1 wf6 4684. wf3 wf2 4685. wf2 wf6 4686. wf3 wf6 4687. wf8 wf6 4688. wf5 wf6 4689. wf5 wf6 4690. wf7 wf6 4691. wf7 wf6 4692. wf7 wf6 4693. wf8+ wf6 4694. wf8+ wf6 4695. wf7 wf6 4696. wf7 wf6 4697. ac2 wf6 4698. wf7 wf6 4699. wf6 wf5 4700. ad3 wf6 4701. wf5 wf6 4702. wf5 wf6 4703. wf1 wf6 4704. wf3+ wf6 4705. wf3 wf6 4706. wf6 wf6 4707. wf6 wf6 4708. wf3 wa5 4709. ad2 wf5 4710. wf3 wf6 4711. wf3 wf6 4712. wf8 wf4 4713. wf7 wf7 4714. wf2 wf6 4715. wf8 wf6 4716. wf8 wf6 4717. wf2 wf6 4718. wf3 wf1 4719. wf2 wf6 4720. wf3 wf1 4721. wf5 wf6 4722. wf8 wf6 4723. wf3 wf1 4724. wf4 [fxf4] 4725. ec3 wf4 4726. wf3 wf4 4727. wa4 wf7 4728. hf1 wf4 4729. fb5+ wf6 4730. wf6+ wf7 4731. ac3 wf4 4732. hf6 wf4 4733. fb2 wf5 4734. cf7 wf6 4735. wf6 wa6 4736. wf4 wf6 4737. wf7 wf6 4738. wf6 wf5 4739. wf2 wf6 4740. wf6 wa6 4741. wf6 wf6 4742. wf7 wf6 4743. wf1 wa5 4744. wf1 wf6 4745. wf1 wf6 4746. wf2 wf6 4747. wf1 wa6 4748. wf8 wf5 4749. wf8 wf6 4750. wf1 wa6 4751. hf5 wf6 4752. wf6 wa6 4753. wf6 wf6 4754. wf8 wf5 4755. wf7 wf6 4756. wf1 wf6 4757. hf1 wf6 4758. wf3 wf6 4759. wf7 wf6 4760. wf8 wa5

4761. cf7 wf6 4762. wf1 wf6 4763. hf1 wf6 4764. wf4 wf6 4765. ac2 wa6 4766. ad3 wa4 4767. wf6 wa6 4768. wf6 wf6 4769. wf6 wf6 4770. hf6 wf7 4771. wd1 wf5 4772. fb2 wf5 4773. fb5 wf5 4774. fl1 wf4 4775. ad3 wf6 4776. wd1 wf4 4777. wf3 wf6 4778. hf5 wf4 4779. wa6 wf4 4780. wf8 wf6 4781. wf8 wf5 4782. ac1 wf4 4783. wa4 wf6 4784. wa6+ wf5 4785. wf1 wf6 wf6 4786. wf3 wf7 4787. fb5+ wf7 4788. fb3 wf7 4789. wf7 wf4 4790. wf8 wf7 4791. wf4 wf7 4792. ac2 wf6 4793. ad3 wf4 4794. wa3 wf4 4795. wa8 wf4 4796. wa8 wf4 4797. ae4 wf4 4798. ad2 wf4 4799. fg7 [h6] 4800. fb1 wf7 4801. wf8 wf4 4802. wf8 wf6 4803. wf1 wf6 4804. ad2 wf4 4805. wf3 wf4+ 4806. wf2 wf6 4807. wf5 wf6 4808. wf3 wa5 4809. wf2 wf6 4810. wf2 wf6 4811. wf3 wf6 4812. wf6 wf6 4813. wf3 wf6 4814. wf3 wa5 4815. wf4 wf6 4816. wf8 wf5 4817. wf6 wf6 4818. wf6 wf6 4819. wf4 wf6 4820. wf8 wf6 4821. wf8 wf6 4822. wf2 wf6 4823. wf7 wf6 4824. wf4 wf6 4825. wf3 wf6 4826. wf4 wf6 4827. wf3 wa5 4828. wf2 wa5 4829. wf8 wa5 4830. wf3 wf6 4831. wf3 wf6 4832. wf5 wf6 4833. wf8 wa6 4834. wf5 wf6 4835. wf2 wf6 4836. wf7 wf6 4837. wf5 wf6 4838. wf6 wf6 4839. ad3 wf6 4840. wf3 wf5 4841. wf2 wf6 4842. wf2 wf6 4843. wf5 wf6 4844. wf2 wf6 4845. wf1 wf6 4846. wf2 wf6 4847. wf5 wf6 4848. wf1 wf6 4849. wf1 wf6 4850. ad3 wf6 4851. wf1 wf6 4852. wf7 wf6 4853. wf8 wf6 4854. wf3 wf6 4855. wf8 wf6 4856. wf8 wf6 4857. wf3 wf6 4858. wf3 wf6 4859. wf3 wf6 4860. wf2 wf6 4861. wa4 wf4 4862. wa3 wf6 4863. wf8 wf6 4864. hf1 wf6 4865. ad2 wf7 4866. ac1 wf6 4867. wf8 wf7 4868. wf2 wf6 4869. wf8 wf6 4870. wf8 wf6 4871. wf1 wf6 4872. hf1 wf4 4873. ad2 wf4 4874. ae4 [fxd4] 4875. wf3 wf4 4876. wf3 wf4 4877. wf7 wf7 4878. wf4+ wf6 4879. fb3+ wf6 4880. wf6 wf6 4881. wf4 wf6 4882. wf6 wf6 4883. hf1 wf6 4884. wf4 wf6 4885. wf3 wf6 4886. wf3 wf6 4887. wf5 wf6 4888. wf5 wf6 4889. wf6 wf6 4890. wf1 wf6 4891. wf6 wf6 4892. wf4 wf6 4893. wf5 wf6 4894. wf5 wf6 4895. wf3 wf6 4896. wf3 wf6 4897. wf4 wf6 4898. wf6 wf6 4899. wf6 wf6 4900. wf1 wf6 4901. wf8 wf6 4902. wf6 wf6 4903. wf6 wf6 4904. wf6 wf6 4905. wf1 wf6 4906. wf2 wf6 4907. wf1 wf6 4908. wf3 wf6 4909. wf6 wf6 4910. wf6 wf6 4911. wf8 wf6 4912. wf5 wf6 4913. wf5 wf6 4914. wf4 wf6 4915. wf5 wf6 4916. wf6 wf6 4917. fa3 wa5 4918. ac1 wf5 4919. wf3 wf6 4920. wa8 wa4 4921. wa8 wf5 4922. wf1 wf6 4923. wf1 wf6 4924. wf1 wf6 4925. wf6 wf6 4926. wf8 wf6 4927. wf8 wf6 4928. wf6 wf6 4929. wf8 wf6 4930. wf3 wf6 4931. wf2 wf6 4932. wf3 wf6 4933. wf1 wf6 4934. hf1 wf6 4935. fb3+ wf6 4936. wa3 wf6 4937. wf6 wf7 4938. wf4+ wf7 4939. wf4 wf7 4940. wf3 wf6 4941. wf1 wf6 4942. wf3 wf6 4943. wf7 wf4 4944. wf8 wf7 4945. wf3 wf6 4946. fb3 wf6 4947. wf2 wf6 4948. wf3 wf6 4949. wf6 [f4] 4950. wf3 wf6 4951. wf1 wf6 4952. wf2 wf6 4953. wf1 wf6 4954. fb3+ wf6 4955. wf6 wf6 4956. wf3+ wf6 4957. wf3 wf6 4958. wf8 wf6 4959. wf2 wf6 4960. wf1 wf6 4961. wf6 wf6 4962. hf3 wf6 4963. wf3 wf6 4964. wf1 wf6 4965. wf2 wf6 4966. fb2 wf6 4967. wf3 wf6 4968. wf3 wf6 4969. wf3 wf6 4970. wf1 wf6 4971. wf8 wf6 4972. wf7 wf6 4973. wf3 wf6 4974. wf8 wf6 4975. wf2 wf6 4976. wf1 wf6 4977. wf6 wf6 4978. wf3 wf6 4979. wf3 wf6 4980. wf3 wf6 4981. wf3 wf6 4982. wf2 wf6 4983. wf2 wf6 4984. hf3 wf6 4985. wf1 wf6 4986. wf3 wf6 4987. wf3 wf6 4988. wf1 wf6 4989. wf8+ wf6 4990. wf8 wf6 4991. wf1 wf6 4992. wf1 wf6 4993. wf1 wf6 4994. wf3 wf6 4995. wf7 wf6 4996. wf1 wf6 4997. hf1 wf6 4998. wf1 wf6 4999. wf1 wf6 5000. wf5 wf6 5001. wf1 wf6 5002. wf1 wf6 5003. wf2 wf6 5004. wf6 wf6 5005. wf3 wf6 5006. wf3 wf6 5007. ac1 wf6 5008. wf3+ wf6 5009. hf3 wf6 5010. wf8 wf6 5011. wf3 wf6 5012. fb3+ wf6 5013. wf3 wf6 5014. wf2 wf6 5015. wf4 wf6 5016. wf3 wf6 5017. wf1 wf6 5018. wf1 wf6 5019. hf1 wf6 5020. wf2 wf6 5021. wf2 wf6 5022. wf3 wf6 5023. wa3 wf6 5024. wf6 [f3] 5025. wa6+ wf6 5026. wa5+ wf6 5027. wf2 wf6 5028. wf4 wf6 5029. wa8 wf6 5030. wf1 wf6 5031. wf1 wf6 5032. wa1 wf6 5033. wf2 wf6 5034. wf3 wf6 5035. wa8 wf6 5036. wf2 wf6 5037. wf6 wf6 5038. wa3 wf6 5039. wf8 wf6 5040. wf6 wf6 5041. wf8 wf6 5042. wf2 wf6 5043. wf1 wf6 5044. wf6 wf6 5045. wf8 wf6 5046. wf8 wf6 5047. wf6 wf6 5048. wf6 wf6 5049. wf8 wf6 5050. wf2 wf6 5051. wf3 wf6 5052. wf1 wf6 5053. wf1 wf6 5054. wa8 wf6 5055. wf8 wf6 5056. wf8 wf6 5057. wf6 wf6 5058. wf8 wf6 5059. wf8 wf6 5060. wf3 wf6 5061. ac1 wf6 5062. wf8 wf6 5063. wf1 wf6 5064. wf8 wf6 5065. wf8 wf6 5066. wf8 wf6 5067. wf3 wf6 5068. wf1 wf6 5069. wf4 wf6 5070. wf3 wf6 5071. ac1 wf6 5072. wa8 wf6 5073. wf7 wf6 5074. wf8 wf6 5075. wf2 wf6 5076. wf2 wf6 5077. wf1 wf6 5078. wf4 wf6 5079. ad2 wf6 5080. wf1 wf6 5081. wa5 wf6 5082. ad2 wf1 5083. wf1 wf6 5084. ad2 wf6 5085. wf2 wf6 5086. wf7 wf6 5087. wf8 wf6 5088. wf8 wf6 5089. wf1 wf6 5090. ad2 wf6 5091. wf6 wf6 5092. wf8 wf6 5093. wf8 wf6 5094. wf6+ wf6 5095. wa2 wf6 5096. wa5+ wf6 5097. wa6+ wf6 5098. wf3 wf6 5099. wf8 [f2] 5100. hf1 wf6 5101. wf5 wf6 5102. wf3 wf6 5103. wf3 wf6 5104. wf3 wf6 5105. wf7 wf6 5106. wf3+ wf6 5107. wf5+ wf6 5108. wf4 wf6 5109. wf1 wf6 5110. wf2 wf6 5111. wf7 wf6 5112. wf4 wf6 5113. wf6 wf6 5114. wf7 wf6 5115. wf1 wf6 5116. wf2 wf6 5117. wa2 wf6 5118. wf2 wf6 5119. wf6 wf6 5120. wf5 wf6 5121. wf5 wf6 5122. wf5 wf6 5123. wf6 wf6 5124. wf6 wf6 5125. wf5 wf6 5126. wf5 wf6 5127. wf5 wf6 5128. wf1 wf6 5129. hf1 wf6 5130. wf2 wf6 5131. wf3 wf6 5132. ad2 wf6 5133. wf1 wf6 5134. ad2 wf6 5135. ac1+ wf6 5136. wf1 wf6 5137. wf4 wf6 5138. wf5 wf6 5139. wf7 wf6 5140. wf8 wf6 5141. wf3 wf6 5142. wf2 wf6 5143. wf6 wf6 5144. wf8 wf6 5145. wf1 wf6 5146. wf1 wf6 5147. wf4 wf6 5148. wf6 wf6 5149. wf5 wf6 5150. wf1 wf6 5151. wf2 wf6 5152. wf1 wf6 5153. wf3 wf6 5154. wf3 wf6 5155. wf5+ wf6 5156. wf3+ wf6 5157. wf1 wf6 5158. wf5 wf6 5159. wf5 wf6 5160. wf6 wf6 5161. wf2 wf6 5162. wf3 wf6 5163. ad2 wf6 5164. wf3 wf6 5165. wf3 wf6 5166. wf3 wf6 5167. wf2 wf6 5168. wf2 wf6 5169. wf6 wf6 5170. wf3 wf6 5171. wf7+ wf6 5172. wf6 wf6 5173. wa4 wf6 5174. wf6 [f1=B] 5175. wf3 wf6 5176. wf3 wf6 5177. wf3 wf6 5178. wf2 wf6 5179. wf4 wf6 5180. wf4 wf6 5181. wf3 wf6 5182. wf1 wf6 5183. wf2 wf6 5184. wf3 wf6 5185. wf2 wf6 5186. wf3 wf6 5187. wf3 wf6 5188. wf3 wf6 5189. wf4 wf6 5190. wf8 wf6 5191. wf3 wf6 5192. wf5 wf6 5193. wf2 wf6 5194. wf2 wf6 5195. wf1 wf6 5196. wf8 wf6 5197. wf8 wf6 5198. ac1 wf6 5199. wf5 wf6 5200. wf4 wf6 5201. wf6 wf6 5202. wf5 wf6 5203. hf1 wf6 5204. wf4 wf6 5205. wf3 wf6 5206. wf3 wf6 5207. wf4 wf6 5208. wf7 wf6 5209. wf6 wf6 5210. wf5 wf6 5211. wf5 wf6 5212. wf5 wf6 5213. wf3 wf6 5214. wf2 wf6 5215. wf2 wf6 5216. wf2 wf6 5217. wf3 wf6 5218. wf2 wf6 5219. wf2 wf6 5220. wf3 wf6 5221. wf3 wf6 5222. wf3 wf6 5223. wf4 wf6 5224. wf3 wf6 5225. wf8 wf6 5226. wf8 wf6 5227. wf2 wf6 5228. wf6 wf6 5229. wf4 wf6 5230. wf3 wf6 5231. wf2 wf6 5232. wf1 wf6 5233. wf3 wf6 5234. wf1 wf6 5235. wf3 wf6 5236. wf6 wf6 5237. wf2 wf6 5238. wf3 wf6 5239. wf1 wf6 5240. wa8 wf6 5241. wa8 wf6 5242. wf2 wf6 5243. wf7 wf6 5244. wf8 wf6 5245. ad2 wf6 5246. ad2 wf6 5247. ac1 wf6 5248. wa3+ wf6 5249. wf3 [fxd3] 5250. wf1 wf6 5251. hf1 wf6 5252. wf1 wf6 5253. wf1 wf6

5487. wq2 2 Xf5 5488. &f6 Md5 5489. Me1 Md4 5490. wq6 &f3 5491. Me4 h1 5492. Qc7 &f3 5493. Mc8 &f4 5494. wq3 &f5 5495. wq6 Md4 5496. Qf5 &f3 5497. Qd4 &f4 5498. Mc8 &f4 5499. wq5 &f5 5500. wq6 Md5 5501. Qc6 Md4 5502. Qc7 &f3 5503. Mc8 &f4 5504. Md4 &f4 5505. wq6 Md4 5506. wq6 Md5 5507. wq2 Md4 5508. Mc8 Md5 5509. Mc8 &f4 5510. h1 &f1 5511. wq6 Md5 5512. wq2 &f5 5513. wq2 &f5 5513. &f1 &f1 5514. wq7 h7 &f5 5515. wq7 h7 &f4 5516. wq6 &f1 5517. Qd3 &f3 5518. Qd4 &f4 5519. Qd4 &f4 5520. wq7 &f5 5521. wq7 h7 &f4 5522. Qd5+ &f3 5523. Qf6 &f4 5524. Qh7 &f5 5525. Qd6 &f5 5526. wq3 &f4 5527. Qf6 &f4 5528. Qf6 &f4 5529. wq4 &f3 5530. Mc8 &f4 5531. Qd4 &f5 5532. &f1 &f5 5533. &f2 &f5 5534. Md1 &f4 5535. h1 &f1 &f6 5536. Mc8 &f5 5537. wq7 &f4 5538. wq8 &f4 5539. wq1 &f5 5540. wq2 &f4 5541. wq1 &f4 5542. Qd2 &f4 5543. wq1 &f6 5544. wq2 &f4 5545. Qd1 &f4 5546. wq8 &f4 5547. Qf6 &f6 5548. wq3 &f6 5549. wq3 [a3] 5550. wq1 &f1 5551. wq7 &f4 5552. wq2 &f4 5553. wq3 &f6 5554. &f1 &f6 5555. wq1 &f6 5556. wq4 &f5 5557. wq4 &f5 5558. wq2 &f4 5559. Mc8 &f6 5560. wq6 &f4 5561. Qd4 &f5 5562. Qd4 &f5 5563. wq7 &f5 5564. Qc8 &f6 5565. Qc8 &f6 5566. wq2 &f6 5567. wq1 &f6 5568. wq6 &f4 5569. wq1 &f6 5570. wq7 &f5 5571. wq6 &f6 5572. Qc6 &f5 5573. wq8 &f4 5574. wq7 &f5 5575. wq2 &f6 5576. Qf1 &f4 5577. Qd2 &f6 5578. Qc3 &f5 5579. Qf2 &f6 5580. wq1 &f1 5581. Qf2 &f6 5582. wq1 &f4 5583. Qf6 &f6 5584. wq8 &f6 5585. Mc8 &f6 5586. wq8 &f6 5587. Qf2 &f6 5588. Qf2 &f6 5589. Qf1 &f1 5590. Qf2 &f6 5591. wq4 &f6 5592. wq4 &f6 5593. Qd1 &f3 5594. Qd1 &f3 5595. wq3 &f6 5596. wq3 &f6 5597. wq3 &f6 5598. wq3 &f6 5599. wq3 &f6 5600. wq3 &f6 5601. wq3 &f6 5602. wq3 &f6 5603. Qe3 &f4 5604. Qd1 &f6 5605. Qd1 &f6 5606. wq7 &f6 5607. wq7 &f6 5608. wq2 &f6 5609. wq2 &f6 5610. wq3 &f6 5611. &f6 &f6 5612. Qd4 &f6 5613. Qf6 &f6 5614. wq6 &f6 5615. Qh5 &f4 5616. Qf6 &f6 &f6 5617. wq8 &f6 5618. wq7 &f6 5619. wq8 &f6 5620. wq1 &f4 5621. Qd5 &f4 5622. Qc6 &f6 5623. wq3 &f6 5624. wq2 [a2] 5625. Qd8 &f6 5626. wq5 &f6 5627. wq1 &f4 5628. Qc6 &f5 5629. wq7 &f6 5630. wq1 &f4 5631. Qf2 &f6 5632. wq1 &f4 5633. Qb4 &f6 5634. Qbd5 &f4 5635. Mb8+ &f7 5636. Mb8 &f6 5637. wq8 &f6 5638. wq8 &f6 5639. wq8 &f6 5640. wq1 &f4 5641. Qc4 &f6 5642. Qd4 &f6 5643. Qd4 &f6 5644. Qb6 &f6 5645. Qf5 &f6 5646. Qd6 &f6 &f6 5647. Qbd5 &f5 5648. wq1 &f6 5649. wq1 &f4 5650. Qd2 &f6 5651. Qf4 &f6 5652. Qc6 &f6 5653. Qc4 &f6 5654. Qd4 &f6 5655. wq4 &f6 5656. wq2 &f6 5657. wq7 &f6 5658. wq7 &f6 5659. wq1 &f4 5660. wq7 &f6 5661. wq7 &f6 5662. wq8 &f6 5663. Qb2 &f6 5664. wq1 &f6 5665. wq1 &f6 5666. wq1 &f6 5668. wq8 &f6 5669. wq8 &f6 5670. wq8 &f6 5671. Mb8+ &f7 5672. Mc8 &f6 5673. wq1 &f6 5674. wq1 &f6 5675. Qb4 &f6 5676. Qc6 &f6 5677. Qb4 &f6 5678. Qc6 &f6 5679. wq1 &f6 5680. Qd4 &f6 5681. Qd2 &f6 5682. Qd1 &f6 5683. Qb2 &f6 5684. Qc1 &f6 5685. Qb2 &f6 5686. wq8 &f6 5687. wq1 &f6 5688. Qb2 &f6 5689. Qd8 &f6 5690. Qc3 &f6 5691. Qb2 &f6 5692. wq8 &f6 5693. wq7 &f6 5694. wq8 &f6 5695. wq3 &f6 5696. wq3 &f6 5697. Qd2 &f6 5698. Qc6 &f6 5699. Qc3 [a1=R] 5700. Qb2 &f6 5701. wq8 &f6 5702. Mc1 &f6 5703. wq5 &f6 5704. Qd4 &f6 5705. Qb3 &f6 5706. Qd4+ &f7 5707. wq5 &f6 5708. Qc6 &f6 5709. wq5 &f6 5710. wq1 &f6 5711. Qd8 &f6 5712. Qf2 &f6 5713. wq2 &f6 5714. Qd4 &f6 5715. Qf6 &f6 5716. Md1 &f6 5717. Me1 &f6 5718. Qb5 &f6 5719. Qb5 &f6 5720. Qd4 &f6 5721. Qf6 &f6 5722. Md1 &f6 5723. h1 &f6 5724. Md1 &f6 5725. Mc1 &f6 5726. Qd1 &f6 5727. Qb3 &f6 5728. wq8 &f6 5729. wq1 &f6 5730. wq2 &f6 5731. Qc3 &f6 5732. Qc5 &f6 5733. Qc6 &f6 5734. Qd5 &f6 5735. Qc5 &f6 5736. Qc6 &f6 5737. wq5 &f6 5738. wq6 &f6 5739. wq8 &f6 5740. Qf6 &f6 5741. Qd4 &f6 5742. Qc3 &f6 5743. Qd2 &f6 5744. wq2 &f6 5745. Qd6 &f6 5746. wq8 &f6 5747. Qd4 &f6 5748. Qc3 &f6 5749. Qd4 &f6 5750. wq3 &f6 5751. wq2 &f6 5752. wq8 &f6 5753. Qc2 &f6 5754. Qc4 &f6 5755. wq6 &f6 5756. wq4 &f6 5757. wq5 &f6 5758. Qd2 &f6 5759. wq8 &f6 5760. Qf6 &f6 5761. Qb2 &f6 5762. wq7 &f6 5763. wq8 &f6 5764. wq5 &f6 5765. Qc6 &f6 5766. Qf6 &f6 5767. h1 &f6 5768. Qf4 &f6 5769. Qe6 &f6 5770. wq3 &f6 5771. wq1 &f6 5772. wq3 &f6 5773. Qd1 &f6 5774. &f5+ &f6 [Xa5] 5775. Qb2 &f6 5776. h1 &f6 5777. Qh7 &f6 5778. wq4 &f6 5779. h1 &f6 5780. wq3 &f6 5781. wq4 &f6 5782. wq8 &f6 5783. wq4 &f6 5784. wq1 &f6 5785. Qf2 &f6 5786. Qd8 &f6 5787. wq3 &f6 5788. wq8 &f6 5789. wq3 &f6 5790. wq7 &f6 5791. wq8 &f6 5792. wq8 &f6 5793. Qf6 &f6 5794. Qh7 &f6 5795. wq5 &f6 5796. wq7 &f6 5797. wq8 &f6 5798. wq8 &f6 5799. wq8 &f6 5800. wq8 &f6 5801. wq4 &f6 5802. Qd3 &f6 5803. Qd1 &f6 5804. wq7 &f6 5805. wq8 &f6 5806. wq4 &f6 5807. Me1 &f6 5808. Qf1 &f6 5809. wq8 &f6 5810. wq4 &f6 5811. Qd4 &f6 5812. wq2 &f6 5813. Mb1 &f6 5814. Mb1 &f6 5815. wq8 &f6 5816. wq2 &f6 5817. wq2 &f6 5818. wq4 &f6 5819. Qd5+ &f6 5820. Qd4 &f6 5821. wq8 &f6 5822. wq4 &f6 5823. wq1 &f6 5825. wq5 &f6 5826. wq5 &f6 5827. wq8 &f6 5828. Qb3 &f6 5829. Qd2 &f6 5830. wq4 &f6 5831. Md1 &f6 5832. Mb1 &f6 5833. Mb8 &f6 5834. wq8 &f6 5835. wq4 &f6 5836. Mb1 &f6 5837. wq7 &f6 5838. wq8 &f6 5839. wq3 &f6 5840. wq1 &f6 5841. Mb1 &f6 5842. Qf6 &f6 5843. wq1 &f6 5844. wq2 &f6 5845. 5845. h1 &f6 5846. Qe8 &f6 5847. Qf6 &f6 5848. Qd1 &f6 5849. Qf4 [c3] 5850. wq5 &f6 5851. Qd2 &f6 5852. Qh7 &f6 5853. Qc6 &f6 5854. wq1 &f6 5855. wq1 &f6 5856. Qf6 &f6 5857. wq5 &f6 5858. wq5 &f6 5859. Mc6 &f6 5860. wq8 &f6 5861. wq1 &f6 5862. Mc8 &f6 5863. 5863. wq1 &f6 5864. Qd6 &f6 5865. wq8 &f6 5866. wq5 &f6 5867. Qf2 &f6 5868. wq1 &f6 5869. wq1 &f6 5870. wq1 &f6 5871. Qd2 &f6 5872. wq1 &f6 5873. wq1 &f6 5874. Qd2 &f6 5875. Qd6 &f6 5876. Qf1 &f6 5877. wq1 &f6 5878. wq1 &f6 5879. wq6 &f6 5880. Qh7 &f6 5881. Qd4 &f6 5882. Qf2 &f6 5883. Qd1 &f6 5884. wq2 &f6 5885. wq2 &f6 5886. Qh8 &f6 5887. wq8 &f6 5888. Qf2 &f6 5889. Qf2 &f6 5890. wq1 &f6 5891. Qd3 &f6 5892. wq8 &f6 5893. wq8 &f6 5894. wq8 &f6 5895. Qe8 &f6 5896. Qf6 &f6 5897. Qf6 &f6 5898. wq4 &f6 5899. wq4 &f6 5900. wq8 &f6 5901. wq8 &f6 5902. Qb6 &f6 5903. Qc4 &f6 5904. wq8 &f6 5905. wq8 &f6 5906. wq8 &f6 5907. wq8 &f6 5908. wq8 &f6 5909. wq8 &f6 5910. wq8 &f6 5911. wq8 &f6 5912. Qf4 &f6 5913. wq8 &f6 5914. Qd2 &f6 5915. wq8 &f6 5916. wq2 &f6 5917. wq8 &f6 5918. Qd4 &f6 5919. wq8 &f6 5920. Qf4 &f6 5921. wq2 &f6 5922. wq2 &f6 5923. wq3 &f6 5924. Qe2 [c2] 5925. wq4 &f6 5926. wq8 &f6 5927. wq3 &f6 5928. Qb3 &f6 5929. Qbd4 &f6 5930. Qd2 &f6 5931. Qc3 &f6 5932. wq5 &f6 5933. wqf4 &f6 5934. wq7 &f6 5935. Qd3 &f6 5936. wq8 &f6 5937. wq1 &f6 5938. wq8+ &f6 5939. Qf5 &f6 5940. Mb1 &f6 5941. Qf2 &f6 5942. Qf3+ &f6 5943. Qe5 &f6 5944. wq3 &f6 5945. Md1 &f6 5946. Mb1 &f6 5947. Qd2 &f6 5948. wq3 &f6 5949. Qf2 &f6 5950. wq8 &f6 5951. Qd8 &f6 5952. Qf3+ &f6 5953. Qf4 &f6 5954. Qf2 &f6 5955. wq2 &f6 5956. wq2 &f6 5957. Mb1 &f6 5958. Qb1 &f6 5959. Qb3 &f6 5960. Qf6 &f6 5961. wq8 &f6 5962. Qf2 &f6 5963. Qf4 &f6 5963. Qf1 &f6 5964. h1 &f6 5965. Qh7 &f6 5966. Qf6 &f6 5967. Qf6 &f6 5968. wq4 &f6 5969. wq4 &f6 5970. Qd1 &f6 5971. wq1 &f6 5972. wq2 &f6 5973. wq8 &f6 5974. Qf2 &f6 5975. Qd1 &f6 5976. wq5 &f6 5977. wq1 &f6 5978. h1 &f6 5979. wq8 &f6 5980. wq2 &f6 5981. wq6 &f6 5982. wq2 &f6 5983. wq8 &f6 5984. wq1 &f6 5985. wq3 &f6 5986. Qb3 &f6 5987. Qc3 &f6 5988. Qd1 &f6 5989. Qd2 &f6 5990. Qd8 &f6 5991. Mc8 &f6 5992. wq4 &f6 5993. Qf3 &f6 5994. Qd2 &f6 5995. Qd2 &f6 5996. Qd2 &f6 5997. Mc8 &f6 5998. h1 &f6 5999. Qf4 [c1=N] 6000. wq7 &f6 6001. wq1 &f6 6002. wq7 &f6 6003. Qf1 &f6 6004. wq7 &f6 6005. Qh5 &f6 6006. Qf2 &f6 6007. wq3 &f6 6008. Qd3 &f6 6009. Qd1 &f6 6010. wq3+ &f6 6011. wq6+ &f6 6012. h1 &f6 6013. Qc4 &f6 6014. h2 &f6 6015. wq6+ &f6 6016. wq6 &f6 6017. wq6 &f6 6018. wq7 &f6 6019. Qh3 &f6 6020. Qh5 &f6 6021. wq5 &f6 6022. wq7 &f6 6023. wq6+ &f6 6024. wq5 &f6 6025. wq7 &f6 6026. Qd3 &f6 6027. Qe6 &f6 6028. Qe4 &f6 6029. wq6+ &f6 6030. wq4+ &f6 6031. wq4 &f6 6032. wq7 &f6 6033. h4 &f6 6034. Qf3 &f6 6035. Qf1 &f6 6036. wq6 &f6 6037. Qb2 &f6 6038. Qd1 &f6 6039. h1 &f6 6040. wq5 &f6 6041. wq6+ &f6 6042. wq3+ &f6 6043. Qd3+ &f6 6044. wq8 &f6 6045. wq7 &f6 6046. Qf2 &f6 6047. Qe3 &f6 6048. Qf1 &f6 6049. wq3 &f6 6050. Qd2 &f6 6051. Qf1 &f6 6052. wq3 &f6 6053. wq3 &f6 6054. wq3 &f6 6055. Qd1 &f6 6056. wq7 &f6 6057. Qf6 &f6 6058. Qf6 &f6 6059. wq5 &f6 6060. wq3 &f6 6061. wq7 &f6 6062. Qh7 &f6 6063. Qf6 &f6 6064. Qd2 &f6 6065. Qf2 &f6 6066. Qd1 &f6 6067. wq7 &f6 6068. Qb2 &f6 6069. Qd1 &f6 6070. wq2 &f6 6071. Qf2 &f6 6072. Qd1 &f6 6073. wq8 &f6 6074. Qe2 [c4] 6075. Md8 &f6 6076. wq6+ &f6 6077. wq6 &f6 6078. Qh5 &f6 6079. Qf6 &f6 6080. Qf1 &f6 6081. wq3+ &f6 6082. h1 &f6 6083. Qd4 &f6 6084. Md8 &f6 6085. Qd4 &f6 6086. Qd2 &f6 6087. wq1 &f6 6088. wq3 &f6 6089. Qd2 &f6 6090. Qb5 &f6 6091. Md8 &f6 6092. Na6 &f6 6093. wq3 &f6 6094. wq2 &f6 6095. wq3 &f6 6096. wq2 &f6 6097. Qa4 &f6 6098. Na6 &f6 6099. Na8 &f6 6100. wq3 &f6 6101. wq2 &f6 6102. Md8 &f6 6103. Qf2 &f6 6104. Qe4 &f6 6105. Qd4 &f6 6106. Qd2 &f6 6107. Qd3 &f6 6108. wq1 &f6 6109. Qf5 &f6 6110. wq1 &f6 6111. Qd2 &f6 6112. Qd2 &f6 6113. Qd2 &f6 6114. wq3 &f6 6115. Qd2 &f6 6116. Qd1 &f6 6117. Qd1 &f6 6118. Qe2 &f6 6119. Qd2 &f6 6120. wq1 &f6 6121. Na8 &f6 6122. Qd4 &f6 6123. Qe2 &f6 6124. Qd2 &f6 6125. Na8 &f6 6126. Na8+ &f6 6127. Na8 &f6 6128. wq2 &f6 6129. wq3+ &f6 6130. wq6+ &f6 6131. Qf4 &f6 6132. Qe2 &f6 6133. h1 &f6 6134. Qf4 &f6 6135. Qf6 &f6 6136. Qh5 &f6 6137. wq8 &f6 6138. h8 &f6 6139. Qe5 &f6 6140. Qf3 &f6 6141. Qd2 &f6 6142. wq6 &f6 6143. wq6 &f6 6144. wq6+ &f6 6145. wq3 &f6 6146. wq5 &f6 6147. wq3 &f6 6148. Md8 &f6 6149. Qd4 [Xe2] 6150. Qb1 &f6 6151. wq5 &f6 6152. Qb2 &f6 6153. Qc3 &f6 6154. Qf2 &f6 6155. wq3+ &f6 6156. Qf4 &f6 6157. wq3 &f6 6158. Mb8 &f6 6159. Qd2 &f6 6160. Qd2 &f6 6161. wq1 &f6 6162. wq8 &f6 6163. wq1 &f6 6164. wq3 &f6 6165. Qf2 &f6 6166. wq8 &f6 6167. wq1 &f6 6168. Qf1 &f6 6169. wq3 &f6 6170. wq2 &f6 6171. Qd2 &f6 6172. wq1 &f6 6173. wq2 &f6 6174. Qd1 &f6 6175. wq8 &f6 6176. Qd4 &f6 6177. Qd2 &f6 6178. Qd4 &f6 6179. wq1 &f6 6180. wq1 &f6 6181. wq3 &f6 6182. Qe2 &f6 6183. wq1 &f6 6184. wq2 &f6 6185. Qc3 &f6 6186. Qd4 &f6 6187. Qf4 &f6 6188. Qd2 &f6 6189. wq1 &f6 6190. Qc3 &f6 6191. Mc8 &f6 6192. Md8 &f6 6193. wq3 &f6 6194. wq3 &f6 6195. wq3 &f6 6196. Mb8 &f6 6197. wq3 &f6 6198. wq3 &f6 6199. Mc8 &f6 6200. h8 &f6 6201. Mc8 &f6 6202. Qc3 &f6 6203. Qf2 &f6 6204. Qc4 &f6 6205. Qf2 &f6 6206. wq2 &f6 6207. wq3+ &f6 6208. wq3 &f6 6209. wq3 &f6 6210. wq3 &f6 6211. wq8 &f6 6212. wq7 &f6 6213. wq3 &f6 6214. wq5 &f6 6215. wq8 &f6 6216. wq5 &f6 6217. Qd1 &f6 6218. wq5 &f6 6219. wq5 &f6 6220. wq8 &f6 6221. wq5 &f6 6222. wq3 &f6 6223. Qd2 &f6 6224. Qe3 [c3] 6225. Qf4 &f6 6226. Qd5+ &f6 6227. Qf6 &f6 6228. wq8 &f6 6229. wq4 &f6 6230. Qf4+ &f6 6231. Qe3+ &f6 6232. Qc3 &f6 6233. wq1 &f6 6234. wq6 &f6 6235. wq6 &f6 6236. wq8 &f6 6237. Qf4 &f6 6238. Mc8 &f6 6239. Qd2 &f6 6240. Qd4 &f6 6241. h1 &f6 6242. Qd5 &f6 6242. wq7 &f6 6243. Qd4 &f6 6244. Qd2 &f6 6245. Qf4 &f6 6246. Qh5 &f6 6247. Qd4 &f6 6248. Mc8 &f6 6249. Qf4 &f6 6250. Qh5 &f6 6251. wq8 &f6 6252. wq5 &f6 6253. Qf5 &f6 6254. Qd3 &f6 6255. Qf5 &f6 6256. Qh3 &f6 6257. wq4 &f6 6258. Qd5 &f6 6259. Qd4 &f6 6260. Qf3 &f6 6261. wq8 &f6 6262. Qh8 &f6 6263. Mc8 &f6 6264. Qf4 &f6 6265. wq4 &f6 6266. Qf6 &f6 6266. Qf6 &f6 6267. Qe1 &f6 6268. Qf5 &f6 6269. Mb8 &f6 6270. wq7 &f6 6271. wq8 &f6 6272. Qd4 &f6 6273. Qf4 &f6 6274. wq4 &f6 6275. wq8 &f6 6276. Qd4 &f6 6277. Qd4 &f6 6278. wq2 &f6 6279. Na8 &f6 6280. Na8 &f6 6281. Qd2 &f6 6282. wq4 &f6 6283. h1 &f6 6284. Qe4+ &f6 6285. Qf6+ &f6 6286. Qc3 &f6 6287. Qd1 &f6 6288. wq3 &f6 6289. wq6 &f6 6290. wq3 &f6 6291. wq1 &f6 6292. Qd5 &f6 6293. Qf6 &f6 6294. Qd5+ &f6 6295. Qe5 &f6 6296. wq7 &f6 6297. wq8 &f6 6298. h1 &f6 6299. Qf5 [c2] 6300. Qd4+ &f6 6301. wq1 &f6 6302. wq7 &f6 6303. Md1 &f6 6304. Qh1 &f6 6305. Qf5 &f6 6306. wq5+ &f6 6307. wq8 &f6 6308. wq6+ &f6 6309. wq7 &f6 6310. Qb2 &f6 6311. Qd2 &f6 6312. Qb2 &f6 6313. Qd2 &f6 6314. Qd2 &f6 6315. Qd2 &f6 6316. Qd2 &f6 6317. wq8 &f6 6318. Qd2 &f6 6319. wq8 &f6 6320. Na5 &f6 6321. Qd4 &f6 6322. Qd2 &f6 6323. Qd2 &f6 6324. Qd2 &f6 6325. Qd2 &f6 6326. Qd2 &f6 6327. Qd2 &f6 6328. Qd2 &f6 6329. Qd2 &f6 6330. Qd2 &f6 6331. Qd2 &f6 6332. Qd2 &f6 6333. Qd2 &f6 6334. Qd2 &f6 6335. wq5 &f6 6336. wq6 &f6 6337. wq7 &f6 6338. wq7 &f6 6339. wq3 &f6 6340. wq2 &f6 6341. wq8 &f6 6342. wq1 &f6 6343. Qd3 &f6 6344. Qd4 &f6 6345. Qd1 &f6 6346. wq1 &f6 6347. wq7 &f6 6348. wq6+ &f6 6349. wq5+ &f6 6350. wq4 &f6 6351. wq7 &f6 6352. wq8 &f6 6353. wq1 &f6 6354. wq5+ &f6 6355. wq6 &f6 6356. wq3 &f6 6357. wq8 &f6 6358. Qf5 &f6 6359. wq2 &f6 6360. wq3 &f6 6361. Qh2 &f6 6362. Qc4 &f6 6363. Qd2 &f6 6364. Qd2 &f6 6365. Qf1 &f6 6366. Qd2 &f6 6367. wq4 &f6 6368. h1 &f6 6369. wq1 &f6

we7 wb5 6954. whb8+ wb6 6955. wd6+ wb5 6956. wb4+ wa6 6957. wd6+ wb7 6958. wd4 wa6 6959. wh2 wa5 6960. wh5 ac5 6961. w7 wa5 6962. wa1 c5 6963. w7 wa4 6964. wb2 wa4 6965. wf3 k1 6966. wf8 ah7 6967. whg7 ad3 6968. whh8 ac5 6969. wh5 kc5 6970. whg7 wa5 6971. wf3 wb6 6972. wf2 ac6 6973. wh8 ac4 6974. wb2 [d6] 6975. wa8 kh1 6976. wa8 xg8 6977. wh5+ wb7 6978. wh8 ab3 6979. wa4 lg4 6980. wb4 kc4 6981. wh3 kf5+ 6982. wf3 kc3 6983. od3 xg7 6984. lbcb8+ wb4 d7 6985. wa4 xg5 6986. wc5 kc5 6987. wh8 hb5 6988. wa4 xg4 6989. wh3 kc1 6990. wb4 kh1 6991. w2 xg5 6992. wa5 ac2 6993. kc4 ab3 6994. wa5 kh1 6995. wa4 khh5 6996. wa4 ac2 6997. c4 kc5 6998. wb4 kc5 6999. wa5 ab3 7000. wa5 xg8 7001. wa5 xg5 7002. wb5 kg4 7003. wb4 hb6 7004. wh3 kh5 7005. wf1 kc1 7006. wh3 kg5 7007. wa5 xg5 7008. c4 kc5 7009. wa4 wc6 7010. wf3 wd7 7011. wha8 kg7 7012. wh8 kg5 7013. wa8 ab3 7014. wb4 khg5 7015. od3 ag7 7016. wh8 ae2 7017. kc1 kf5 7018. wh1 kgf7 7019. wa8 ahg7 7020. wb8 kg4 7021. wd8 hf3 7022. whc8+ wd7 7023. lb8 c7 7024. wa5 xg8 7025. od3 kg1 7026. wb2 lg4 7027. wf1 kc4 7028. kc1 hb5 7029. wh4 kf5+ 7030. wa5 kc5 7031. wd2 kc4 7032. wh8 kc4 7033. wf8 kc1 7034. fh8 kg1 7035. wa4 lg4 7036. wb5 kg1 7037. wf3 wa4 7038. wb5 xg3 7039. lb8 xg8 7040. wd4 hb6 7041. wf8+ wa7 7042. wbh5 wb6 7043. dd1 xg4 7044. wa1 kc4 7045. wa8 kg4 7046. wf1 wh1 7047. fh5 ac2 7048. wa8 ac4 7049. kg1 [d5] 7050. we5 kh4 7051. wf1 kg6 7052. hh1 wc5 7053. wf7 kg1 7054. wf3 kc6 7055. wf3 ka8 7056. hh8 kaal 7057. od3+ wb5 7058. od3+ wa4 7059. wf1+ c5 7060. wa5 7061. wa2 a3 7062. wh5 ka4 7063. wg5 kb5 7064. gc3+ kd4 7065. wf4 ad1 7066. we3 kf1+ 7067. wf3 wa5 7068. wf7+ wb5 7069. wd8 wc5 7070. wf7+ wb5 7071. wf4 c5 7072. wf5 kb5 7073. wh5 ah2 f2 7074. wf3 ad1+ 7075. wf2 kg1+ 7076. wf3 ab3 7077. wf1 c4 7078. wa5 ac3 7079. wh5 ka4 7080. wf3+ ad4 7081. wf5 kd4 7082. fh7 wa5 7083. wf7 ab5 7084. wf6 ac3 7085. wf1 kg6 7086. wf1 kg5 7087. wh8 kg1 7088. wf1 ac2 7089. wf1 kg4 7090. wf1 kg1 7091. wf1 ka1 7092. wf6 kb6 7093. wh5 kc6 7094. wf2+ wb4 7095. wf1+ wa4 7096. wf3 wb4 7097. wf5 kb5 7098. wf3 kb6 7099. od3 kc6 7100. wf1+ c5 7101. od3+ c6 7102. od2 c5 7103. hh8 ka7 7104. hh1 ad3 7105. wa8 ka4 7106. kd8 ka5 7107. fh5 kc1 7108. wf8 xg5 kg1 7109. wh8 kg6 7110. we5 ab1 7111. wf2 hf8 kg1 7112. wd3 kc1 7113. we5 ag3 7114. fh8 ae2 7115. wa8 wb6 7116. wa8 ka6 7117. wf1 ka5 7118. wa4 kg4 7119. we5 kg7 7120. wf1 kg4 7121. wa5 kg5 7122. we5 wb5 7123. wf8 hb6 7124. wa4 [d4] 7125. wc5+ wb7 7126. wf7 kh3 7127. wf7 khh3 7128. wa6 kc3 7129. wd6 kg6 kg3 7130. kg5 ka6 7131. od1 kg6 7132. kg5 kh8 7133. wa8 kb3 7134. kf5 ac8 7135. wf3 kc6 7136. wf7 ka4 7137. wd7+ wb6 7138. we8 ka4 7139. wf3 kc6 7140. wd3 kc5 7141. wf8 kc5 7142. wd8+ c7 7143. wf6+ c5 7144. wa4 ab7 7145. wa6 kc8 7146. wd3 kh7 7147. wf8 hc8 7148. fh8+ wb6 7149. fh6+ c6 7150. wf7 kc5 7151. wf3 kc8 7152. wd8+ c6 7153. wf8 hb6 7154. wa8 kc4 7155. wf8 kc6 7156. we8 kh5 7157. wf3 kc8 7158. wa8 kf6 7159. wa8 kb5 7160. wf5 kb3 7161. wh3 ka4 7162. c3 kb7 7163. wf4 d7+ wb6 7164. wd6+ wb7 7165. wa5 ka4 7166. wa8 hb5 7167. kg7 kh8 7168. wa6 kg6 7169. wa8 ka4 7170. wc5 ka3 7171. kg5 ac6 7172. kf5 kc3 7173. kg5 ag3 7174. wa8 ae2 7175. wf5 khh3 7176. wf8 hf7 7177. wf2 khh3 7178. wa8 kg3 7179. wa8 hf7 7180. od2 ae6 7181. dd8 ac4 7182. dd8 kh1 7183. wa8 kh3 7184. wa8 kg4 7185. wa8 kh4 7186. wa8 khh3 7187. whh5 kc1 7188. wa6 ka3 7189. wa8 ka4 7190. we5 kh1 7191. wc5 ad5 7192. wf7 ac4 7193. wa4 ka5 7194. wh8 kg8 7195. fh8 kg4 7196. wd5+ wb6 7197. wf5+ wa6 7198. wc5 wb6 7199. wf3 [d3] 7200. wf2 ka7 7201. wf3 ac3 7202. fh8h6+ wb7 7203. wa6+ wf7 7204. wa2 xgh4 7205. wf2 kf1 7206. wa4 ka5 7207. wf5 ka4+ 7208. wf3 fb4+ 7209. wf3 kd4 7210. wf8 kh4 7211. fh8 wf3 7212. wf5 wf1 7213. kg4 ka6 7214. wf2 kc5+ 7215. od2 kb5 7216. kc3 kc4 7217. wf8g8 khb1 7218. wf5+ wd7 7219. wh5 kb6 7220. we2 ad5 7221. wh5 wd6 7222. we8 wd7 7223. we8 kb3 7224. wd2 c6 7225. wa3 ac3 7226. wa2 kc6 7227. wh5 kb6 7228. we5 kb1 7229. wh5 ka1 7230. wf5 ka1 7231. wf4 c7 7232. wf5+ wb7 7233. wf5 c7 7234. wa1 kb5 7235. wa4 kg4 7236. kg7 ka4 7237. fh3 fa4 7238. wf3 hc5+ 7239. wd2 kc5 7240. wf3 kb5 7241. kg4 khh1 7242. hb4 ac4 7243. kg4 kh8 7244. xg8 hb1 7245. wf4 kf1 7246. wf5 wb7 7247. wf5 wf7 7248. wf2 ka5 7249. fh3 kd4 7250. wf2 kd8 7251. fh8 fa4 7252. wf3 kf4+ 7253. wf3 kd4+ 7254. wf3 hf4 7255. wf3 ag8 7256. wh5 ac4 7257. wd2 ka7 7258. wf3 kb5 7259. od2 ac4 7260. fh8 kf1 7261. fh8 fa6 7262. kg2 ka7 7263. wf1 kg4 7264. wa2 wb7 7265. wf6+ wf7 7266. fh8h6+ wf6 7268. fh7h6+ wf6 7269. wh8 kg4 7270. fh4 kc4 7271. fh8 ae6 7272. wf2 ac4 7273. wf3 ka5 7274. wf2 [d2] 7275. wf7 kh3 7276. wa8 kd3 7277. wf6f6+ kc6 7278. wf8 kc5 7279. wf5 ka4 7280. whh6 ac2 7281. kg7 kh6+ 7282. kg2 khh4 7283. wh8 kh1 7284. od4+ wd5 7285. kg6 xgh4 7286. wa8 ab5 7287. wd6+ wa4 7288. wa3 ka4 7289. wf7 ag4 7290. wb8 ac8 7291. wb2 kb1 7292. wf8 wb7 7293. wa1 kc5 7294. lb8 ka5 7295. fh8 ag2 7296. wf2 hf4 7297. fh6 ac8 7298. wh6 ka5 7299. wf7 ka5 7300. wf7 kh1 7301. wf7 kg5 7302. wa3 ka5 7303. kd2 ag4 7304. kg2 ba4 7305. wa8 kc4 7306. hb2 ah5 7307. fhg2 kc8 7308. wf7g6 ka4 7309. wa8 kb6 7310. wa8 h4h2 7311. wd6 kh4 7312. wf7 wd5 7313. wd6+ wf4 7314. wf6 wf5 7315. whg7 ka6 7316. wh6 kb5 7317. wh8 ka5 7318. od2 kg4 7319. od4 kb6 7320. wf7 kc6 7321. c3+ c5 7322. od4+ wb5 7323. od2 c5 7324. wa8 khh4 7325. wh8 hb2 7326. wa8 khh4 7327. wf1 hb2+ 7328. wf3 hf8+ 7329. wf2 kd1 7330. xg8 ae2 7331. wa6 ad3 7332. wa8 xgh4 7333. whh8 kg4 7334. fh3 ac8 7335. fh6 hf7 7336. wd2 kh3 7337. wf7 wb6 7338. xg8 kb6 7339. fh8 kb3 7340. wf4 kc1 7341. fh6+ wf7 7342. wf7 wb6 7343. kg3 ac4 7344. wd2 c7 7345. wa8 wb6 7346. fh8 kh1 7347. fh8 kg5 7348. fh5 kb4 7349. wh2 [d1=rd] 7350. kg3 khg1 7351. wf2 kc5 7352. fh4 kd8 7353. sh8 ad5 7354. dd4+ c5 7355. dd1 kg5 7356. dd6 ka3 7357. hh8 kc8 7358. wh1 kb8 7359. fh8 kc3 7360. wh8 ac3 7361. hh6 kb3 7362. wh3 kb8 7363. dd2 ac2 7364. wa2 kg3 7365. wf4g4 ad5 7366. wf2 wf5 7367. kc6 kd8 7368. wa5+ ad5 7369. dd2 ac3 7370. wa7 hb8 7371. wf4 ac4 7372. hh6 ae2 7373. hb6 wd5 7374. hh6 af3 7375. whh3 ae2 7376. wa4 wc5 7377. wa2 kb2 7378. xgh4 kb8 7379. kg6 kg5 7380. dd2 kc3 7382. kg3 ac4 7383. xgh3 kb7 7384. dd6 kb8 7385. wf4 kb3 7386. wf4 ae2 7387. wh1 ac4 7388. wf4 kb8 7389. xgh4 kc5 7390. wh8 kc3 7391. wf4 ae2 7392. wf4 kb3 7393. fh8 kc3 7394. xg6 ka3 7395. xg8 af7 7396. wa8 ac4 7397. fh4d2 kc8 7398. wh4 kc2 7399. fh4d2 kc1 7400. kg6 kd8 7401. dd6 ad3 7402. wa8 ac4 7403. dd3 ka5 7404. dd6 kc1 7405. dd1 kg1 7406. wf4 kg4 7407. dd4 kd6 7408. od2 ac4 7409. wf8 ad5 7410. dd4+ wf6 7411. wf4 ad5 7412. wd2 kb3 7413. wf4 kd2 7414. wh8 kd8 7415. fh8 dd1 7416. fh4 wf6 7417. fh8 wa6 7418. kg3 wb6 7419. wh2 hf1 7420. wf2 kg7 7421. wf2 kg4 7422. wf3 ac3 7423. wf2 kg8 7424. wf3 [e6] 7425. wh8 ad5+ 7426. wf2 kaal 7427. wf6h3 wa5 7428. wf7+ wb5 7429. fh8 kd1 7430. wf8 kg4 7431. kg7 af3 7432. wf3 kh1+ 7433. wf3 hf1+ 7434. od2 kd4+ 7435. od3 kh4 7436. kd8 kg8 7437. od5 ac4 7438. od4 ce2+ 7439. wd3 kc4+ 7440. od2 kc5 7441. wd5+ wf4 7442. wa4 kg2 7443. wf7 ka1 7444. wf3+ wb5 7445. wf3 kc3 7446. wa7 kg5 7447. wa7 kg4 7448. dd3d3 kc5 7449. dd4d4 kb3 7450. wf4 khh4 7451. wh3 wb4 7452. wf3+ c5 7453. wf3 kb6 7454. fh8 ka1 7455. fh7 af3 7456. fh8 hb5 7457. wd5+ wb4 7458. wd8 wb5 7459. wf3 kc3+ 7460. od2 kc2+ 7461. wf2 kc1 7462. wd2 ac6 7463. od5 af3 7464. dd7 ac3 7465. dd7 hf1 7466. od3 khh4 7467. wf3 kc8 7468. wf3 c4 7469. wf8+ wb7 7470. od2 kd4+ 7471. od3 kd4 7472. od2 kb2 add1+ 7473. wf3 kc1+ 7474. wf2 kf1+ 7475. wf3 kh1 7476. wf2 kg6 7477. wh3 kg4 7478. wh5+ ad5 7479. wh3 kg2 7480. wf7 ad5 7481. fh7 kg1 7482. wf7 wa7 7483. wf7 kaal 7484. wf5 kgd1 7485. wf7 kd1 7486. wf2 kh1 7487. wf6+ wa5 7488. wf7+ wa6 7489. wfch2 wa5 7490. wf6 wb6 7491. wf7 ad4 7492. wh6 kd1 7493. wh8 wa5 7494. fh8h6 ac2 7495. wf3 ad5+ 7496. wf3 ac4 7497. wf3 kg6 7498. fh8 kg8 7499. wf4 [e5+] 7500. wf5 af7 7501. wd2h5 kh3 7502. we6+ wb5 7503. fh6 ad5 7504. we6 ka4 7505. dd6 ka2 7506. od3 kf2+ 7507. od4 kf2 7508. lb6+ wf4 7509. wh3 ab7 7510. wf3 ac3 7511. fh6f6 kb1 7512. kc8+ ac6 7513. kc8b8 kf2 7514. xgh6 kf3 7515. hb2 kc2 7516. kc8 xg2 7517. fh8 kc3 7518. wa8 kc2 7519. wh8 kd1 7520. we7 kd1 7521. we6 kf1 7522. wa8 fh3 7523. fhfh4 kg2 7524. wa4 kf6 kg2 7525. fh8 kg2 7526. lb5 kc2 7527. fh3 kd1 7528. kc8 kd1 7529. whh4 kg8 7530. whh6 ka3 7531. kc8b8 ab1 7532. whh4 kc1 7533. wh6 kg3 7534. kg2 kc8 7535. lb8b2 kf2 7536. wf2 kb3 ab5 7537. whg5 ac6 7538. wd6 kf2 7539. fh6 hf6 wf7 7540. kc8+ ac6 7541. fh8 ab7 7542. wf4 ac3 7543. wf5g5 ka6 7544. wh8 ab7 7545. wd8 ac4 7546. wf5 ad6 7547. wf5h5 dd1 7548. lb5 ad5 7549. lb3 kh1 7550. lb6 kb3 7551. wd8 wb5 7552. lb6+ wa5 7553. dd6 wb5 7554. od3 kf2+ 7555. wf4 ka2 7556. od3 kg4 7557. od2 kg8 7558. wh4 ka5 7559. wh4h5 kd1 7560. we6 kh3 7561. wh8 hf7 7562. wh8 hf3 7563. we6 ad5 7564. kg4 af7 7565. kg2 ad5 7566. we6 kc3 7567. wf7 kb6 7568. we6+ wf7 7569. we8 wb6 7570. wf2 kh1 7571. kg2 kb1 7572. wh2 kb1 7573. wh2h2 ac4 7574. wh2 [e4+] 7575. we8e5 dd5 7576. wf1 hf1 7577. hb8+ c5 7578. wf3 ka2 7579. wa8 kf1+ 7580. wf3 kg5+ 7581. wf6 kf2 7582. we6 kf1 7583. fh8b8 7584. wa6 kb5 7585. wa8 hf7 7586. hb3 kb5 7587. wa6 ad4 7588. we6+ wa4 7589. dd6 kf5 7590. wh8 hf7 7591. wf3 kd4 7592. fh6 kc7 7593. g6d7 ka7 7594. xg8 kc7 7595. xg8g3 ab3 7596. dd6 ad3 7597. we5 hf7 7599. xg3 kc5 7599. wh3 kf5 7600. wf5 kd5 7601. wf3 kg3 hf7 7602. we5 kf1 7603. wh4 hf4 7604. wh2 ac2 7605. hb8 ad4 7606. kc3 kf7 7607. hb3 c7 7608. kc6+ wb4 7609. lb6 kc6 7610. wh4 fa4 7611. wf4 ac2 7612. wa6 dd2 7613. wf2 kc5 7614. wf2h2 wa7 7615. wa3 kf7 7616. fh8 kf1 7617. hb8 hf7 7618. fh3 hb5 7619. dd3 kg5 7620. fh3 kf1 7621. wa8 hf1 7622. lb6 kd2 7623. lb8b8 ac3 7624. fh8 ac4 7625. d3kf1 kc1 7626. fh3 kg8 7627. wf6 kg5 7628. we6 hf1 7629. whh2 kb3 7630. wf5 kg5+ 7631. c6 wf6 7632. wf5 kf1 7633. wf3 kf1+ 7634. wf6 kg1 7635. wf5 wf6 7636. wa8b5 wf5 7637. wf4 ac3 7638. wf5 af1 7639. kg2 ac4 7640. wa8 wb6 7641. lb8h8+ wf7 7642. lb8c5 wb6 7643. kg3 hf1 7644. wf2 kd5 7645. kc8e8 7646. wf2 kd1 7647. wf2 kaal 7648. weh8 wa5+ 7649. wf6 [e3] 7650. wh5 wf7 7651. wb5 kd3 7652. wh8 kd2 7653. we6 ka2 7654. wa5 ae2 7655. wa8 hf1 7656. kc8 kc6 7657. kg6 ag4 7658. wf1 ac2 7659. fh8 af3 7660. od3 kb2 7661. wd6 af4 7662. wh6 ag6 7663. c4 ka8 7664. hc1 ac3 7665. fh4 ac5 7666. wa4 wb6 7667. kg5 ab7 7668. fh2 dd2 7669. wa3 kf7 7670. wa4 kc8 7671. c4 kd1 7672. wa4 ka1 7673. fh4 kd1

7674. wh7 aa8 7675. wh6 hb2 7676. kg8 hb2 7677. wf3+ wa7 7678. wa4+ wb8 7679. wf5+ wf7 7680. fh5 ag6 7681. fh4 kd2 7682. fh4 kb2 7683. wd7 kc1 7684. wd6 kc1 7685. kc4 kd1 7686. fh8 af3 7687. wf6 ac4 7688. kc8 af3 7689. whb5 af4 7690. wh5 kcal 7691. wh1 kacl 7692. wd5 ac2 7693. wf5 ka4 7694. wa5 ka2 7695. ac5 kb2 7696. od3 kf1 7697. od2 kb1 7698. wh3 ag4 7699. wh5 ac3 7700. kg6 ae2 7701. fh8 ac3 7702. ka4 ac2 7703. kc8 ad5 7704. wf2 ac3 7705. hb8 kg8 7706. kc8 ag4 7707. fh8 ae2 7708. we8 kh1 7709. wf5 wb1 hf1 7710. fh8 hf1 7711. wf6 ac4 7712. wf6 ka5 7713. wf6 kd4 7714. fh8 kd2 7715. fh2 kd3 7716. kg2 hf1 7717. wh2 hf1 7718. wa6 kd1 7719. wh2 kd1 7720. wh5 kd1 7721. hf2 hf2+ wb6 7722. wf2 kb1 7723. wh8 kb1 7724. kg3 [e2] 7725. wf2 ka2 7726. wf5 ab1 7727. wf3 ag6 7728. wf2 kb7 7729. fh7 kb7 7730. wa5 aa4 7731. hb5+ wa7 7732. wf5 kf7 7733. wf4 kc2 7734. wf2 c6+ 7735. wf5 kc5 7736. fh3 kd3 7737. fh2 kc3 7738. wh4d4 xg7 7739. fh7 kh8 7740. wf1 af5+ 7741. wf4 kc8 7742. wf5 kg2 7743. fh8 hf7 7744. wec3 xg7 7745. od3 kg2 7746. od2 kb2 wf6 7747. wf1 kf7 7748. wd5 kh8 7749. wf4 ag4 7750. fh7 kg2 7751. wd6 kg7 7752. wd4 ka3 7753. dd3 kc3 7754. wf6 kc3 7755. wd4 gh7 7756. wf5 kg7+ 7757. wf6 ag6 7758. wf5 hf1 7759. wef2 kh8 7760. fh3 hf1 7761. dd8 kb8 7762. wa8 hb4 7763. wh8 hf1 7764. wf1 kd3 7765. wf2 hf7 7766. wf2 hf7 7767. dd8 kd1 7768. wa8 kd2 7769. fh7 kd1 7770. wf6 kc6+ 7771. wf5 kb2 7772. wf6 kd1 7773. we4 kd1 7774. wa8 kc1 7775. wa8 kd3 7776. wf6 dd1 7777. wh5 kb7 7778. wh8 wb6 7779. hb5+ wa7 7780. wa5+ wb6 7781. fh8 ac3 7782. wa8 kb7 7783. kg5 kb7 7784. wf3 ka7 7785. wf2 ac2 7786. fh8 kc1 7787. wf6 ka5 7788. wf6 ka4 7789. wf8 wa5 7790. wa8 ab1 7791. wf3 ka2 7792. wf2 ka5 7793. fh5 ka2 7794. kg5 kd7 7795. kg3 dd1 7796. wf3 ac4 7797. wf2 kd5 7798. xgh2 dd1 7799. wf2 [e1=Q] 7800. wf2h5 kd3 7801. kc8 ad1 7802. wd5 kd4 7803. kg3 we8 7804. wd6+ wb7 7805. wf7+ wa6 7806. wa4 hf1 7807. dd3 kg3 7808. fh3 ad1 7809. wf7 kb5 7810. od2 kb3 7811. fh8 wd5 7812. whh7 ka4 7813. lb4 wa8 7814. wf5 ad7 7815. hc4 kc3 7816. lb6 ab5 7817. wh8 kd3 7818. wf5 kb4 7819. wd6 kb1 7820. wf7 wd8 7821. fh3 wa8 7822. hb8 kc3 7823. kc8 kc8 7824. whh7 wa8 7825. wf8 wa6 7826. wf7 c8 7827. hb4 ad7 7828. hb8 kg3 7829. hb4 kb1 7830. kc8 kb1 7831. wd6 hb3 7832. wd7 ka4 7833. wf6 kd4 7834. wf5 ad5 7835. lb8 ka3 7836. hb3 ka4 7837. wf1 ka5 7838. wee7 kg5 7839. wh4 kg3 7840. wd7 wf5 7841. we7 ab2 7842. fh8 ad1 7843. fh3 af1 7844. hb3 kg7 7845. od4 kg3 7846. we3 we8 7847. hb3 wf5 7848. wh8 we8 7849. dd8 ac4 7850. hb3 hf7 7851. dd3 kh1 7852. fh3 kg8 7853. dd3 wf7 7854. wf3 we8 7855. wf7 kc1 7856. wf7 kg5 7857. wf6 kg8 7858. we1 wb7 7859. we7+ wb6 7860. wd6+ wb7 7861. wd5+ wb6 7862. wf6 we1 7863. kg3 kaal 7864. wf4 kb5 7865. we5 kd3 7866. wf5 ka4 7867. wd5 wa5 7868. fh8 ac3 7869. fh8 ab1 7870. we8 ac3 7871. kc8 dd1 7872. we8 wd2 7873. wh2 we1 7874. od3 [xkd3] 7875. wf2 ka4 7876. dd2 khg1 7877. wf8+ wa5 7878. wf8+ wb5 7879. wf8+ wb5 7880. wf7+ wa6 7880. wf7+ wa6 7881. dd8 kg2 7882. dd8 kb1 7883. wd8 ka3 7884. wf3 kaal 7885. hb2+ wa6 7886. we6+ wa7 7887. wf5 ad5 7888. wh2 a2 7889. wh8 dd1 7890. wd4+ wa6 7891. wd4 wa4 7892. kc2 ab5 7893. hb2 wb7 7894. kc8 ad5 7895. fh8h6 we2 7896. dd2 ka6 7897. hb2 ka4 7898. wh8 kaal 7899. sh8 7900. xg8 hf7 7901. hf8 ac4 7902. wf2 wa6 7903. hb2 we3 7904. kc2 ac4 7905. wh1 ac3 7906. wh1 kd1 7907. hf8 kd1 7908. dd2 ka1 7909. hb2 wa7 7910. wd4+ wa6 7911. wd8 wa7 7912. xg8 kd5 7913. fh8 kf5 7914. wd2 hf5 7915. wf3 ac4 7916. wf2 kb5 7917. wh8 kd5 7918. hb5 kd3 7919. hb2 wa6 7920. we6+ wa7 7921. kc8 wa6 7922. hb2 wb5 7923. hb2+ wa6 7924. dd2 wb5 7925. wa8 ka3 7926. wd8 ka3 7927. wf8 ka3 7928. wf6 ka4 7929. wec3 kc1 7930. wf7 we4 7931. wa8 we1 7932. wd2 hf8 7933. fh8 kh3 7934. we8 kd3 7935. wf4 kc5 7936. we7+ wa6 7937. wf7+ wf5 7938. wf8g7 wa5 7939. wf8 wb7+ wa5 7940. wa8+ wb5 7941. wf8+ wa5 7942. wf4 wf6 7943. wf8+ wa5 7944. wf5h2 wf6 7945. we4 hf1 7946. we8 ka5 7947. fh2 ka4 7948. kg2 ka5 7949. kg1 [xgkg1] 7950. wa4 kaal 7951. wh2h3 kg7 7952. sh8h6 kd7 7953. dd4 kg1 7954. wh7 ka2 7955. kc8 ka7 7956. wf7 kf7 7957. wd1 c6 7958. wh6 wf3 7959. dd5 kg2 7960. wh5 hf4 7961. dd3 kh2 7962. dd3 ka4 7963. whh7 ab3 7964. wd6+ wa5 7965. wf4 hf3 7966. fh5+ wf4 7967. we7 kg2 7968. wf7 kc3 7969. fh8 wf2 7970. we8 khb2 7971. wf6g6 kf7 7972. fh5 af7 7973. wf8 hf3 7974. wf2 kd2 7975. wf5 wf3 7976. dd7 wf4 7977. we4+ wb5 7978. wf6+ wa6 7979. wf4 wf5 7980. dd2 kh2 7981. dd7 wf6 7982. wd6+ wb5 7983. dd3d3+ wf6 c6 7984. hb8 aa2 7985. kc8 hb6 7986. wh5 c6 7987. wf3 kc3 7988. wh5 ab5 7989. dd5 ac3 7990. wf1 kb4 7991. od3 khh1 7992. dd1d1 kh4 7993. wh6 kh1 7994. wa8 hf1 7995. kc8 hf3 7996. dd4 kg3 7997. hf4 wf1 7998. dd4 kg3 7999. wh7 xg1 8000. dd2 wf6 8001. wf4 kg4 8002. wf3 kg1 8003. wd5 ka7 8004. wf3 kc2 8005. fh3 kc1 8006. wf7h5 kd7 8007. wh7 kb3 8008. fh8 aa2 8009. kg8 ac4 8010. fh8 kd3 8011. wh6h6 ac4 8012. wf4 kg7 8013. dd4 ka3 8014. wa4 kaal 8015. wf4 kd3 8016. we4 kc2 8017. wh8 kc1 8018. fh4 kf1 8019. wa4 ad1 8020. wh2 ac3 8021. wf2 ka5 8022. wf2h2 kg3 8023. we8 kg1 8024. fh8h3 [xh3] 8025. fh7 aa2 8026. wd2 khg3 8027. hb7+ wf5 8028. wa7 hf3 8029. wf7 kf3+ 8030. wf4 kb3 8031. wh2 we2 8032. wf2 hf2+ 8033. wf7 ka3 8034. xg8h8 c2 8035. wa6 kb1 8036. kc8+ wf6 8037. wf8 kc3 8038. wf7+ wa5 8039. we2 wd2+ 8040. wd6 wf6 8041. we1 kf3 8042. we5+ wf5 8043. wf7 kf3 8044. wf7 kd3+ 8045. wf5 kb3 8046. we5 ac6 8047. wf7 c6 8048. kg2 kf3 8049. xg8 kd1+ 8050. dd6 kd1 8051. we4 wf4 8052. we5+ wf4 8053. we1 wf5 8054. wf7 ka3 8055. fh8 kg3 8056. we2 kg1 8057. we7 wd2+ 8058. wd6 kc3 8059. wf7 c6 8060. we8 wf3 8061. wh7 wf6 8062. wf7+ wa6 8063. wf8+ wf6 8064. kg4 kc2 8065. xg8h8 kb4 8066. we7 kb1 8067. wf7+ wa5 8068. wf8+ wf6 8069. wa6 wf5 8070. wf6 kb3 8071. wa6 hf2 8072. wh6 hf1 8073. wf8 wf2 8074. wf7 kd1 8075. wf7 kd1 8076. fh8 kf5 8077. wf7 we1+ 8078. wf6 wf2+ 8079. wf5 we2+ 8080. wf6 kc2 8081. wh2 kc1 8082. we1 kf1 8083. wf7 ka3 8084. wf4 wa5 8085. wf4 kd3+ 8086. wf4 hf3 8087. wf2 kh3 8088. wa7 kh3 8089. wf2 hf3 8090. wf2 kb6 8091. hb7+ wf5 8092. fh7 wf6 8093. wf5 kg3 8094. wd2 kg7 8095. wh2 kg1 8096. wf2 kc3 8097. we8 hb5 8098. fh8 wa5 8099. wa8 [xka8] 8100. wd6+ wa7 8101. we8 ab5 8102. we2 kg6+ 8103. wf5 ka6 8104. we5 hf2 8105. we5 kc2 8106. wd4 ad3+ 8107. we8 kb8 8108. we5 kb2 8109. dd5 kb8 8110. dd8 kg6 8111. we5 wf1 8112. wf5 kc8 8113. hb8 kc5+ 8114. wf4 kd5 8115. dd8 kb2 8116. kg6 kg2 8117. dd6 kb5 8118. wf4 ac4 8119. we6 ka2 8120. dd3 kb2 8121. dd6 kc5 8122. wf4 kc5 8123. we6 kb3 8124. dd6 hf6 8125. wf6 hf3 8126. wf5 hf5 8127. wf6 hf6 8128. dd8 hf6 8129. fh8 kg2 8130. dd8 aa4 8131. we4 kc3 8132. wf8 kb6 8133. dd8 hb6 8134. hb8 kb6 8135. fh8 kc5 8136. hb8 kc7 8137. wf5 kc5+ 8138. wf4 kc8 8139. wf5 kg6 8140. dd8 hb6 8141. wf5 kg8 8142. wf5 kb1 8143. we5 hf6 8144. we8 we1 8

♀f2+ ♀c3 8393. ♀h4 ♀h3 8394. ♀g3 ♀hh1 8395. ♀h4 ♀g4 8396. ♀e1 ♀gg1 8397. ♀e6+ ♀a5 8398. ♀e1 ♀g5 8399. [♂xc1] ♀f3+ 8400. ♀e7 ♀fg3 8401. ♀d2 ♀f1 8402. ♀f2 ♀a4 8403. ♀f5 ♀g6 8404. ♀d5 ♀b5 8405. ♀a2+ ♀b4 8406. ♀c2 ♀a5 8407. ♀c1 ♀d1 8408. ♀g5 ♀d8 8409. ♀f6 ♀d6 8410. ♀e4 ♀gg8 8411. ♀e4 ♀sg6 8412. ♀d2 ♀h6 8413. ♀e4 ♀a6 8414. ♀g6 ♀e8+ 8415. ♀f6 ♀b3 8416. ♀g7 ♀a8 8417. ♀g5 ♀d1 8418. ♀g6 ♀c8 8419. ♀g4 ♀a8 8420. ♀g6 ♀c3 8421. ♀g5 ♀g3 8422. ♀g4 ♀b3 8423. ♀d1 ♀hh8 8424. ♀g6 ♀h6 8425. ♀f6 ♀e8 8426. ♀g7 ♀f7 8427. ♀f6 ♀g8 8428. ♀e7 ♀e8+ 8429. ♀d7 ♀d8+ 8430. ♀e7 ♀f8 8431. ♀e4 ♀d8 8432. ♀c4+ ♀a5 8433. ♀e4 ♀h7 8434. ♀e2 ♀h6 8435. ♀d1 ♀hg6 8436. ♀c2 ♀b6 8437. ♀e4 ♀a5 8438. ♀g4 ♀gg8 8439. ♀e4 ♀e8 8440. ♀e6 ♀d6 8441. ♀g4 ♀g6 8442. ♀c6 ♀b3 8443. ♀f6 ♀bg3 8444. ♀h8 ♀b5 8445. ♀f6 ♀a7 8446. ♀g5+ ♀b5 8447. ♀c3 ♀d1 8448. ♀g5 ♀f6 8449. ♀c1 ♀fg6 8450. ♀c4 ♀f1 8451. ♀c1 ♀d4 8452. ♀c2 ♀b5 8453. ♀d1 ♀b4 8454. ♀c2 ♀cf3 8455. ♀a2 ♀g3 8456. ♀h2 ♀a4 8457. ♀a2+ ♀a3 8458. ♀d5 ♀ag3 8459. ♀c6 ♀c3 8460. ♀d5 ♀c6 8461. ♀f5 ♀cg6 8462. ♀c5 ♀g5 8463. ♀f5 ♀h5 8464. ♀f2 ♀f7 8465. ♀f6 ♀a5 8466. ♀e7 ♀e8 8467. ♀d2 ♀f7 8468. ♀d6 ♀h1 8469. ♀e7 ♀h8 8470. ♀c1 ♀h1 8471. ♀f6 ♀f3+ 8472. ♀e7 ♀fh3 8473. ♀f6 ♀a6 8474. [♂xc3] ♀d5 8475. ♀b3 ♀e4 8476. ♀c2 ♀b3 8477. ♀g2 ♀b7 8478. ♀h2 ♀a5 8479. ♀b8 ♀f1+ 8480. ♀e7 ♀e5+ 8481. ♀d8 ♀b4 8482. ♀a7+ ♀b5 8483. ♀f2 ♀g1 8484. ♀d2 ♀c5 8485. ♀h6 ♀bb1 8486. ♀f6 ♀bc1 8487. ♀d6 ♀g3 8488. ♀e7 ♀g7 8489. ♀e3 ♀a5 8490. ♀e5 ♀c3 8491. ♀e3 ♀g3 8492. ♀f6 ♀a8 8493. ♀e7 ♀cd3+ 8494. ♀e8 ♀dc3 8495. ♀d8 ♀c6 8496. ♀e4 ♀a8 8497. ♀h7 ♀b7 8498. ♀e4 ♀g2 8499. ♀e3 ♀g3 8500. ♀c1 ♀g7 8501. ♀e3 ♀b5 8502. ♀e5 ♀a5 8503. ♀f5 ♀c1 8504. ♀e5 ♀e7 8505. ♀e3 ♀g7 8506. ♀c3+ ♀b5 8507. ♀c3 ♀a1 8508. ♀e7 ♀ac1 8509. ♀f8 ♀g3 8510. ♀e7 ♀cg1 8511. ♀d6 ♀gc1 8512. ♀f8 ♀gg1 8513. ♀d6 ♀b4 8514. ♀f6 ♀b5 8515. ♀f4 ♀b1 8516. ♀f6 ♀be1 8517. ♀h6 ♀b1 8518. ♀f8 ♀b4 8519. ♀h6 ♀a4 8520. ♀d2 ♀b5 8521. ♀f2 ♀e5 8522. ♀d2 ♀f1 8523. ♀f2 ♀a6 8524. ♀a7+ ♀b5 8525. ♀b8 ♀a6 8526. ♀d7 ♀b3 8527. ♀d8 ♀ef5 8528. ♀e7 ♀e5+ 8529. ♀d7 ♀a5 8530. ♀e7 ♀f3 8531. ♀f6 ♀b7+ 8532. ♀g6 ♀h1 8533. ♀f6 ♀bb1 8534. ♀d2 ♀b3 8535. ♀b2 ♀g5 8536. ♀h2 ♀c8 8537. ♀g2 ♀b7 8538. ♀f7 ♀e4 8539. ♀f6 ♀g4 8540. ♀c2 ♀g5 8541. ♀e7 ♀bh3 8542. ♀f6 ♀g4 8543. ♀b3 ♀g5 8544. ♀b1 ♀d5 8545. ♀b3 ♀g8 8546. ♀c3 ♀d5 8547. ♀d4 ♀f7 8548. ♀c3 ♀b6 8549. [♂xh3] ♀a7 8550. ♀e7 ♀a6 8551. ♀d6 ♀g6+ 8552. ♀e5 ♀d5 8553. ♀f1+ ♀b7 8554. ♀f5 ♀g7 8555. ♀c1 ♀g8 8556. ♀a1 ♀f8+ 8557. ♀e5 ♀a2 8558. ♀b1+ ♀b3 8559. ♀f1 ♀c2 8560. ♀f4 ♀c8 8561. ♀a4 ♀c7 8562. ♀f6 ♀h7 8563. ♀b3+ ♀c6 8564. ♀c2+ ♀d7 8565. ♀g7 ♀g8 8566. ♀c6+ ♀e7 8567. ♀c3 ♀c5 8568. ♀c2 ♀h7 8569. ♀c3 ♀g8 8570. ♀a5 ♀c7 8571. ♀c3 ♀d7 8572. ♀c6+ ♀e7 8573. ♀c2 ♀d7 8574. ♀h2 ♀h7 8575. ♀c2 ♀f5 8576. ♀f6 ♀h7 8577. ♀c2 ♀c6 8578. ♀c2+ ♀b6 8579. ♀b3+ ♀c6 8580. ♀d1 ♀b7 8581. ♀b3+ ♀a8 8582. ♀a4+ ♀b7 8583. ♀e6 ♀c2 8584. ♀f6 ♀h2 8585. ♀e5 ♀h1 8586. ♀e6 ♀c8 8587. ♀e5 ♀c3 8588. ♀f4 ♀c8 8589. ♀c3 ♀f8 8590. ♀f4 ♀fh8 8591. ♀f1 ♀f8 8592. ♀c4 ♀b3 8593. ♀f1 ♀c8 8594. ♀b1 ♀b7 8595. ♀d1 ♀c2 8596. ♀b1+ ♀c8 8597. ♀f1 ♀b7 8598. ♀d4 ♀d5 8599. ♀e5 ♀a8 8600. ♀f5 ♀f8+ 8601. ♀f6 ♀g8 8602. ♀a1 ♀a2 8603. ♀c1 ♀d5 8604. ♀c2 ♀g7 8605. ♀c1 ♀b3 8606. ♀f1 ♀d5 8607. ♀g1 ♀g6 8608. ♀f1 ♀gh6 8609. ♀e5 ♀g6 8610. ♀f2 ♀a6 8611. ♀f1+ ♀c4 8612. ♀h3 ♀d5 8613. ♀g4 ♀f7 8614. ♀h3 ♀g4 8615. ♀d6 ♀g6+ 8616. ♀e6 ♀g5 8617. ♀h3 ♀b1 8618. ♀e7 ♀h1 8619. ♀f3 ♀a7 8620. ♀h3 ♀g7 8621. ♀f6 ♀g5 8622. ♀a3+ ♀b6 8623. ♀h3 ♀c5 8624. [♂xf7] ♀gg1 8625. ♀g3 ♀h8 8626. ♀b3 ♀e1 8627. ♀a2 ♀e7+ 8628. ♀f6 ♀e3 8629. ♀g5 ♀ee8 8630. ♀a5+ ♀c4 8631. ♀f6 ♀e6+ 8632. ♀g5 ♀c6 8633. ♀e5 ♀g6+ 8634. ♀f5 ♀gh6 8635. ♀e2+ ♀b3 8636. ♀e4 ♀e8+ 8637. ♀d3 ♀ee6 8638. ♀f3 ♀e5 8639. ♀g2 ♀hh5 8640. ♀f3 ♀a3 8641. ♀h3 ♀h7 8642. ♀g2 ♀d7+ 8643. ♀c4 ♀de7 8644. ♀d3 ♀d7+ 8645. ♀c3 ♀h7 8646. ♀d3 ♀a7 8647. ♀h3 ♀h7 8648. ♀f5 ♀h5 8649. ♀h3 ♀b5 8650. ♀f3 ♀be5 8651. ♀f4 ♀b3 8652. ♀f3 ♀eg5 8653. ♀g2 ♀e5 8654. ♀c4 ♀h6 8655. ♀g2 ♀g5 8656. ♀f3 ♀e5 8657. ♀c6 ♀ce6 8658. ♀f3 ♀a4 8659. ♀c2 ♀b3 8660. ♀e4 ♀e8 8661. ♀c2 ♀d8+ 8662. ♀e4 ♀e8+ 8663. ♀f4 ♀eh8 8664. ♀e4 ♀g8 8665. ♀f5 ♀gh8 8666. ♀f2 ♀c4 8667. ♀e2+ ♀a5 8668. ♀e5+ ♀c4 8669. ♀d6 ♀g6 8670. ♀e5 ♀d6 8671. ♀g5 ♀g6+ 8672. ♀f4 ♀c6 8673. ♀g5 ♀d8 8674. ♀a5 ♀h8 8675. ♀f5 ♀e6 8676. ♀g5 ♀e5+ 8677. ♀f6 ♀e6+ 8678. ♀f5 ♀ee8 8679. ♀f6 ♀d4 8680. ♀g5 ♀c4 8681. ♀e1 ♀c5 8682. ♀a5+ ♀d4 8683. ♀a2 ♀c5 8684. ♀a6 ♀e3 8685. ♀a2 ♀c6 8686. ♀f6 ♀c5 8687. ♀f7 ♀e7+ 8688. ♀f6 ♀e1 8689. ♀f7 ♀d6 8690. ♀b3 ♀c5 8691. ♀a4 ♀g1 8692. ♀b3 ♀c1 8693. ♀g3 ♀g1 8694. ♀g6 ♀hh1 8695. ♀g3 ♀e1 8696. ♀h3 ♀eg1 8697. ♀h7 ♀g5 8698. ♀h3 ♀c6 8699. [♂xh1+] ♀b6 8700. ♀g1+ ♀a5 8701. ♀e1+ ♀a4 8702. ♀e8 ♀h1 8703. ♀a1+ ♀b4 8704. ♀e5 ♀b1 8705. ♀c5+ ♀b3 8706. ♀c7 ♀f1 8707. ♀a7 ♀g1 8708. ♀a1 ♀h1 8709. ♀g7 ♀b4 8710. ♀g2 ♀b3 8711. ♀g4 ♀h4 8712. ♀g2 ♀f4 8713. ♀c2+ ♀b4 8714. ♀c7 ♀f1 8715. ♀h2 ♀f7 8716. ♀h1 ♀c5 8717. ♀h6 ♀a7 8718. ♀h1 ♀f7 8719. ♀d5+ ♀b4 8720. ♀h1 ♀a5 8721. ♀h2 ♀b4 8722. ♀g3 ♀f1 8723. ♀h2 ♀b5 8724. ♀c7 ♀b4 8725. ♀d7 ♀f4 8726. ♀c7 ♀a4 8727. ♀c2+ ♀b4 8728. ♀d2+ ♀b3 8729. ♀c2+ ♀a3 8730. ♀g2 ♀b3 8731. ♀d7 ♀h4 8732. ♀e8 ♀c3 8733. ♀g4 ♀b3 8734. ♀d4 ♀h1 8735. ♀g4 ♀c2 8736. ♀g2+ ♀b3 8737. ♀c6 ♀b4 8738. ♀g2 ♀f1 8739. ♀g7 ♀h1 8740. ♀g5 ♀b3 8741. ♀g7 ♀h7 8742. ♀a1 ♀h1 8743. ♀f7 ♀g1 8744. ♀e8 ♀b1 8745. ♀a7 ♀g1 8746. ♀a8 ♀f1 8747. ♀a7 ♀f2 8748. ♀c7 ♀f1 8749. ♀e5 ♀b1 8750. ♀c7 ♀h1 8751. ♀c5 ♀b1 8752. ♀c1 ♀b4 8753. ♀c5+ ♀a4 8754. ♀e5 ♀b4 8755. ♀f8 ♀g1 8756. ♀e8 ♀a4 8757. ♀a1+ ♀b4 8758. ♀e1+ ♀a4 8759. ♀c3 ♀g5 8760. ♀e1 ♀h5 8761. ♀f7 ♀g5 8762. ♀d1+ ♀a5 8763. ♀e1+ ♀b5 8764. ♀g1 ♀a5 8765. ♀g2 ♀b6 8766. ♀g1+ ♀b5 8767. ♀h1 ♀b6 8768. ♀c1 ♀b5 8769. ♀a1 ♀c6 8770. ♀h1+ ♀d7 8771. ♀f6 ♀e8 8772. ♀g2 ♀g8 8773. ♀e6 ♀g7 8774. [♂xg7] ♀d8 8775. ♀h7 ♀c8 8776. ♀g7 ♀b8 8777. ♀f5 ♀a8 8778. ♀c3 ♀b7 8779. ♀g6 ♀a8 8780. ♀d3 ♀b8 8781. ♀f7 ♀c7 8782. ♀f6 ♀b7 8783. ♀d7+ ♀b8 8784. ♀d2 ♀c7 8785. ♀c3+ ♀b6 8786. ♀g6 ♀b7 8787. ♀c2 ♀a7 8788. ♀c7+ ♀a8 8789. ♀g3 ♀b7 8790. ♀g1 ♀c6 8791. ♀f1 ♀b7 8792. ♀g5 ♀a8 8793. ♀f4 ♀a7 8794. ♀c1 ♀a8 8795. ♀c3 ♀a7 8796. ♀c2 ♀a8 8797. ♀c8+ ♀a7 8798. ♀c7+ ♀a8 8799. ♀c8+ ♀a7 8800. ♀c2 ♀a8 8801. ♀c3 ♀a7 8802. ♀c1 ♀a8 8803. ♀f4 ♀a7 8804. ♀f1 ♀a8 8805. ♀d1 ♀b7 8806. ♀f1 ♀b8 8807. ♀g6 ♀b7 8808. ♀h3 ♀c6 8809. ♀f1 ♀c5 8810. ♀g1+ ♀c6 8811. ♀a1 ♀b7 8812. ♀g1 ♀a8 8813. ♀g3 ♀b7 8814. ♀c7+ ♀a8 8815. ♀d8+ ♀a7 8816. ♀c7+ ♀a6 8817. ♀c2 ♀a7 8818. ♀f2+ ♀b7 8819. ♀c2 ♀b6 8820. ♀c3 ♀b7 8821. ♀f6 ♀b6 8822. ♀b2+ ♀c7 8823. ♀c3+ ♀d6 8824. ♀d2+ ♀c7 8825. ♀c2+ ♀b8 8826. ♀d2 ♀a8 8827. ♀d7 ♀b8 8828. ♀d4 ♀b7 8829. ♀d7+ ♀a8 8830. ♀d3 ♀b7 8831. ♀b5+ ♀c7 8832. ♀d3 ♀b6 8833. ♀f7 ♀c7 8834. ♀h3 ♀b8 8835. ♀d3 ♀a7 8836. ♀g6 ♀b8 8837. ♀c3 ♀a8 8838. ♀d3 ♀b7 8839. ♀c3 ♀a8 8840. ♀f5 ♀b7 8841. ♀g7+ ♀a8 8842. ♀g6 ♀b8 8843. ♀g7 ♀c8 8844. ♀c6 ♀b8 8845. ♀h7 ♀c8 8846. ♀h6 ♀d8 8847. ♀h7 ♀e8 8848. ♀g7 ♀d8 8849. [♂d7+] 1-0

- [7] Axel Thue. über unendliche zeichenreihen. *Norske Vid Selsk. Skr. I Mat-Nat Kl.(Christiana)*, 7:1–22, 1906.
- [8] Wikipedia. Fifty-move rule. http://en.wikipedia.org/wiki/Fifty-move_rule.
- [9] Wikipedia. Threefold repetition. http://en.wikipedia.org/wiki/Threefold_repetition.
- [10] Victor Zakharov and Vladimir Makhnichev. Lomonosov endgame tablebases, 2012. https://chessok.com/?page_id=27966.

References

- [1] FIDE Handbook – E.I.01. Laws of chess, 2020. handbook.fide.com/chapter/E012018.
- [2] Max Euwe. Mengentheoretische betrachtungen über das schachspiel. *Proc. Konin. Akad. Wetenschappen*, 1929.
- [3] Saul Kripke. Outline of a theory of truth. *The Journal of Philosophy*, 72(19):690–716, 1975.
- [4] Tom Murphy, VII. Survival in chessland. In *A Record of the Proceedings of SIGBOVIK 2019*. ACH, April 2019.
- [5] Tom Murphy, VII, Ben Blum, and Jim McCann. It still seems black has hope in these extremely unfair variants of chess. In *A Record of the Proceedings of SIGBOVIK 2014*, pages 21–25. ACH, April 2014. sigbovik.org/2014.
- [6] N. J. A. Sloane. Thue-Morse sequence. <https://oeis.org/A010060>.

Optimizing the SIGBOVIK 2018 speedrun

leo60228
@leo60228

April 1, 2020

Abstract

SIGBOVIK 2018 [1] is a popular game. However, very little work has been put into optimizing its speedrun. In this paper, I will demonstrate usage of pathfinding algorithms for the goal of making the optimal speedrun of SIGBOVIK.

1 Motivation

I was bored.

2 Method

I first looked at implementations of pathfinding algorithms in Rust. I initially wanted to use A* because it was popular. However, the API looked complicated. I found an implementation of DFS to use instead. This DFS implementation required me to define a start point, one or more end points, and a function to map from point to points. I implemented all three of these, using an enum of Start, Success, and Page, because I forgot that there was only one success page.

I used a depth first search algorithm in order to create the mapping. To do this, I clicked as far as possible along the first choices, adding to my mapping (a `match` block) as I went, then backtracking once I reached a cycle or the end. I then manually removed cycles because I wasn't sure if the DFS implementation I was using supported them and I didn't feel like writing my own.

After I had defined these three functions, I simply used the `pathfinding` [2] crate's DFS function. This gave me an optimal path to program into LiveSplit One [3], a tool for speedrunning that I've seen speedrunners use, so I probably should too if I'm speedrunning. I opened it on my phone and added the order that my code gave me.

I recorded my phone and computer screen while I began the speedrun. I then combined the phone and computer screen and attempted to sync them from memory in a video editor. I then uploaded it to YouTube [4].

3 Results

My speedrun was 17.88 seconds, which I'm pretty sure is a world record among the SIGBOVIK 2018 speedrunning community. It can be viewed at <https://youtu.be/VPrT8Y-aRRs>. My code will be available on GitHub at <https://github.com/leo60228/sigbovik2018> if I remember to make it non-private after SIGBOVIK.

4 Appendix: Code

```
use pathfinding::directed::dfs::dfs;

#[derive(Debug, PartialEq, Eq, Copy, Clone)]
pub enum Page {
    Start,
    Success,
    Page(isize),
}

macro_rules! pagevec {
    ($($page:expr),*) => {
        vec![$(Page::Page($page)),*]
    }
}

impl Page {
    pub fn successors(&self) -> Vec<Self> {
        match self {
            Page::Start => pagevec![47, 177, 205],
            Page::Page(47) => pagevec![153, 206],
            Page::Page(153) => pagevec![17],
            Page::Page(17) => pagevec![35, 135],
            Page::Page(35) => pagevec![51, 68],
            Page::Page(51) => pagevec![68], // cycle
            Page::Page(68) => vec![], // cycle
            Page::Page(135) => pagevec![124, 183],
            Page::Page(124) => pagevec![116, 88],
            Page::Page(116) => pagevec![208],
            Page::Page(208) => vec![Page::Success],
            Page::Page(88) => pagevec![208],
            Page::Page(183) => pagevec![207, 208],
            Page::Page(207) => vec![],
            Page::Page(206) => vec![],
            Page::Page(177) => pagevec![130, 117],
            Page::Page(130) => pagevec![154, 39],
        }
    }
}
```

```

    Page::Page(154) => pagevec![17],
    Page::Page(39) => vec![],
    Page::Page(117) => pagevec![87, 50, 28],
    Page::Page(87) => pagevec![69, 40, 28],
    Page::Page(69) => vec![], // cycle
    Page::Page(28) => vec![], // cycle
    Page::Page(50) => vec![], // cycle
    Page::Page(40) => pagevec![178], // cycle
    Page::Page(178) => pagevec![208], // cycle
    Page::Page(205) => vec![],
    Page::Success => pagevec![],
    _ => unimplemented!("{:?}", self),
}
}
}
fn main() {
    println!("{:?}", dfs(Page::Start, Page::successors, |x| x == &Page::Success));
}

```

5 Appendix 2

I just realized I probably should have used more sections, so here's one.

References

- [1] Association for Computational Heresy. Message from the Organizing Committee. In *Proceedings of SIGBOVIK 2018*. ACH, Pittsburgh, PA, USA, March 29, 2018.
- [2] Samuel Tardieu. `pathfinding`. <https://crates.io/crates/pathfinding>
- [3] LiveSplit. LiveSplit One. <https://one.livesplit.org>
- [4] Google. YouTube. <https://youtube.com>

**Retraction of
a boring follow-up paper to
“Which ITG Stepcharts are Turniest?”
titled, “Which ITG Stepcharts are
Crossoveriest and/or Footswitchiest?”**

Ben Blum

bblum@alumni.cmu.edu

In my 2017 paper, a boring follow-up paper to *Which ITG Stepcharts are Turniest?* titled, *Which ITG Stepcharts are Crossoveriest and/or Footswitchiest?* (Blum 2017), I wrote of maximum \mathcal{T} , XO%, FS%, and JK% values as follows:

A chart could conceivably end right before such a step, sneaking through some small ϵ extra turniness (VII 2014) (similar to the case of 270s in (Blum 2016)),

[...]

By the way, the theoretical maxima for XO%, FS%, and JK% are $50-\epsilon$, $100-\epsilon$, and $100-\epsilon$, respectively (VII 2014).

However, in the experimental results, *Tachyon Epsilon* (Matt 2013) placed among the lowest-ranking stepchart packs in every category, yet I neglected to properly cite Dr. VII’s landmark paper from 2014 at that time. Though we may never know know what, if anything, is Epsilon? we now know at least what it is not: crossover and/or footswitchy.

In conclusion, please reject my paper. I messed up on it.

References

- B. Blum. Which ITG stepcharts are turniest? SIGBOVIK, 2016.
- B. Blum. Which ITG stepcharts are crossoveriest and/or footswitchiest? SIGBOVIK, 2017.
- M. Matt. Tachyon epsilon, 2013.
- T. VII. What, if anything, is epsilon? SIGBOVIK, 2014.



CONFIDENTIAL COMMITTEE MATERIALS

SIGBOVIK'20 3-Blind Paper Review

Paper 18: Retraction of a boring follow-up paper to “Which ITG stepcharts are turniest?” titled, “Which ITG stepcharts are crossoveriest and/or footswitchiest?”

Reviewer: Reviewer 5/7

Rating: 5/7

Confidence: Supercharged Chevy Silverado

We believe the subject of this paper is of utmost importance to the field, and appreciate its timeliness, timeline, timbre, and temerity. That being said, in order to be accepted into this prestigious venue, the we suggest the following changes:

- The main methodology is seriously flawed and must be addressed.
- The authors used the word “whilst” 11 times. We recommend a minimum “whilst” usage count of 20 to be seriously considered for publication.
- The English language writing in this paper contains numerous spelling and grammar errors. Consider kidnapping a native English speaker, chaining them in your basement, and depriving them of food until the draft is written in language that William Strunk would be proud of.
- Please use raster rather than vector images for all figures, so that the reader may count the pixels used in the each letter of the text in the axis labels.
- In order to give due credit to all contributors to this work, please make Reviewer 5/7 a co-author.
- On page 44, line 13, eight word, second character, we found the letter “o.” We like this letter, please leave it as is.
- Additional changes have been suggested in the attached PDF.

Programming Languages

7 Continuation passing style

Cameron Wong, Dez Reed

Keywords: continuation, continuation, control flow, programming languages

8 Formulating the syntactically simplest programming language

Brendon Boldt

Keywords: programming languages, compilers, formal grammars

9 Type-directed decompilation of shell scripts

Spencer Baugh, Dougal Pugson

Keywords: partial evaluation, type systems, shell scripting

10 Verified proof of $P=NP$ in the Silence theorem prover language

Matias Scharager

Keywords: soundness, $P=NP$, theorem prover, Silence, programming language theory, type theory

Ntinueation Copassing Style

Cameron Wong, Dez Reed

Abstract—We applied the categorical technique of “do that thing, but backwards” to continuation passing style to produce a novel programming idiom utilizing the `COME FROM` control flow operator.

I. INTRODUCTION

Continuations are an important abstraction in the analysis and description of functional programs. By manipulating them, a savvy programmer can express complex control flow precisely and unambiguously. Unfortunately, with great power comes great responsibility, and code written in continuation-passing style is often obtuse and unreadable to those without such arcane knowledge. It is even said that CPS is merely an obfuscation technique designed to terrorize novice functional programmers and has no practical benefit.

Of course, obscure intermediate forms and programmer-facing implementations thereof need not be restricted to *functional* programs. A reasonable analogue may be the vaunted Static Single Assignment form, in which the programmer may need to use mystical φ -functions. As it turns out, however, SSA is actually equivalent to CPS and is therefore cheating. No, to achieve true parity, a different approach is needed.

Towards this end, we take a page from category theory, applying the time-worn approach of “flip everything backwards and see what happens”. Monads embed impurity to a pure language, so too can comonads embed (enforced) purity into an impure language, and thus “ntinueation copassing style”^{*} is born.

A continuation is a typesafe abstraction of the “return address”. In other words, invoking a continuation is a type-safe delimited `GOTO`. A ntinueation, then, is the opposite of `GOTO`. For wisdom as to what, precisely, this entails, we turn to the programming language `INTERCAL`. While `INTERCAL` *does* have a form of `GOTO`, it also implements the `COME FROM` operator, which is precisely the opposite of `GOTO`!

What is copassing? The type of a CPS function in a traditional functional language typically involves

^{*}Categorically-inclined readers may protest that we have not properly complemented the “style”. The authors believe that code written using `COME FROM` is already pretty much the opposite of “stylish”, and thus is already complementary.

$(\lambda a \rightarrow \lambda b) \rightarrow \lambda b$, which has arrows. Entering into the true categorical spirit and flipping the arrows, then, suggests that “copassing” a ntinueation must be typed at $(\lambda a \leftarrow \lambda b) \leftarrow \lambda b$. Unfortunately, this doesn’t mean anything, but it is fun to write and look at.

II. NTINUEATIONS

In continuation passing style, the core observation is that, by passing the continuation as an argument, it allows the callee to manipulate it to construct new continuations and call them as necessary. In this way, the state of the overall program after any given subroutine invocation is neatly encapsulated into the continuation.

To flip this around, then, a ntinueation would be to increase expressiveness by removing control of not only the state of the program on subroutine return, but also the condition on which the return occurs.

A NCS-transformed function may contain no local variables, but instead relies entirely on its parameters and global, mutable state. The ntinueation, then, is subject to an exit condition imposed on the global state of the program. This process is known as “copassing” or “catching” the ntinueation. [†]

This construction mimics the vaunted `COME FROM` control flow operator from the `INTERCAL` programming language in that a ntinueation represents a “trapdoor” that wrests control flow from the encapsulated routine on a given condition being met. In the true imperative spirit, ntinueations are given meaning entirely by global state and the manipulation thereof.

III. EXAMPLE

Here is the factorial function, written in Ntinueation Copassing Style psuedo-code extended with ntinueations and subroutines:

```
ROUTINE fact:
  PLEASE NOTE that the input is passed in the
  1: SET y TO y * x
  SET x TO x-1
  PLEASE COME FROM (1) WITH y WHEN x EQUALS 0
```

[†]An initial draft of this work was titled “termination catching style”, which perhaps more neatly encapsulates this idea, but after much debate, we settled on “ntinueation” because it would be funnier watching people attempt to pronounce it.

In true INTERCAL fashion, the line beginning with `PLEASE NOTE` is a comment, as it begins with the text “PLEASE NOT”[‡].

This is the standard iterative formulation of the factorial function that multiplies the global result variable y by a loop counter x until x reaches 0. The key difference, however, is in the wrapped recursive call to `fact` that declares a new continuation which aborts computation and returns to that point.

Note that, should multiple exit conditions apply at once, it is nondeterministic which trapdoor opens, as in the original formulation in INTERCAL. In this case, all trapdoors lead to the same place with the same condition, so they will take control one after the other in some nondeterministic order, but do nothing before yielding control to another trapdoor. Finally, after all trapdoors are opened, the routine halts with the value of y containing the result of the factorial.

IV. CONCLUSION

We have presented a novel control flow operator in the style of continuation passing style by attempting to “reverse the arrows”. In fact, the idea of conditional trapdoors (encapsulating `COME FROMs`) mimic that of pre-empting interrupts that take control from a process. In this way, just as CPS allows for precise manipulation of control flow by manipulating a subroutines’ next steps, NCS does the reverse by moving all control flow into global condition triggers, allowing programmers to focus on the individual steps of a given operation. We expect this tool to become key in an imperative obfuscator’s toolbox.

In future work, we hope to explore whether, as CPS forms a monad, NCS forms a true comonad (in fact, we believe that NCS *also* forms a monad, but we did not confirm this).

[‡]The authors originally intended to give this example in an extended INTERCAL, but gave up after four hours of whiteboarding a multiplication algorithm.

FORMULATING THE SYNTACTICALLY SIMPLEST PROGRAMMING LANGUAGE

Brendon Boldt

Language Technologies Institute
Carnegie Mellon University

ABSTRACT

The syntax of a programming language is one of its most visible characteristics, and thus, heavily shapes how users both interact with and view the language. Abstruse syntax correlates to lower usability, and therefore, lower adoption of a programming language. In light of this, we present a programming language with the simplest possible syntax. In addition to the language specification we give a basic style guide and reference implementation.

Keywords programming languages · compilers · formal grammars

1 Introduction

As computers become further and further prevalent in modern day society, computer literacy similarly grows in importance. Taking the analogy further, composition is to literacy as computer programming is to computer literacy. A novice programmer will often find it difficult to address the syntax of a programming language at first, which hinders the acquisition and fluency with the semantics of the programming language [6]. In order to lessen this barrier of entry, we will explore a programming language with the simplest possible syntax.

The complexity of the syntax of a grammar is dependent on a number of well-defined factors: number of rules, cardinality of unique terminals (tokens), and number of terminals and non-terminals per production. These are all further characterized by probabilistic factors, namely their distributions and associated information-theoretic entropies. Determining the equivalence of two grammars is an undecidable problem, and the computation of the entropy of grammars and their syntax trees is an open area of research [7]. Thus, these considerations are beyond the scope of this paper. Regardless of the formal specifications of complexity and entropy, we assert that fewer unique tokens, fewer rules, and lower branching factors all correspond to simpler syntax.

The core concept of our programming language is that of simplicity. Fittingly, the name we have chose for the programming language is “SimPL” standing for “Simple Programming Language”.⁰ We present the formal specification of SimPL 2 in Section 2.²

1.1 Related Work and Scope

SimPL bears some resemblance to so-called “esoteric” programming languages or “esolangs.” Such programming languages typically try to maximize goals, such as minimality and creativity, that typical programming languages typically leave by the wayside. Two well-known esolangs are brainfuck and Unlambda which are a Turing tarpit and Church quagmire respectively [2]. Such tarpits and quagmires seek to limit the semantics of a programming language to the bare minimum as a demonstration of how little is required to be computationally universal.

Another direction of programming language minimalism comes in the form of *one instruction set computers* (OISCs) [1]. These are specifically *machine* languages which provide only one instruction (operator) which, in turn, can take

⁰ This is not to be confused “SymPL” or “Symbol Programming Language” which is the true name of APL.

² The astute reader will notice that we have skipped straight to SimPL 2 (typically, 1 comes before 2). For an explanation of this, see Footnote 1 (although 2 has preceded 1 in this case).

variable arguments. While OSICs and SimPL both center around the idea of “unity” in terms of representing a program in a language of some sort, SimPL does this at the level of a programming language while OSICs are, by definition, concerned with instruction sets.

While the aforementioned languages are mostly interested in testing the limits of minimalism in computability (either through limited semantics or instruction sets), our work adheres to area of language design purely with respect to syntax and syntactic usability. Thus, rather than introducing a language with entirely new semantics as well as syntax, we will recycle familiar semantics packaged in a novel syntactic model. In this sense, our language bears similarities to transpiled languages such as CoffeeScript or Dart.

2 Language Specification

2.1 Syntax

We begin with the Backus-Naur form of SimPL.

$$\begin{aligned} \langle start \rangle &::= \langle expr \rangle \\ \langle expr \rangle &::= \langle tok \rangle \langle expr \rangle \\ &\quad | \langle empty \rangle \end{aligned}$$

Note that there is only one lexical token SimPL, which can be represented an arbitrary charcter, emoji, or any other kind of thing. While we give the BNF of the grammar here. We have artfully crafted the syntax such that it does not need to be expressed as a context-free grammar (Type-2 on the Chomsky hierarchy). We can, in fact, express the syntax of SimPL with a finite state automaton (representing a Type-3 grammar). While this specification seems small, one could imagine it smaller, but we ran into serious problems attempting to use a simpler specification than presented above.¹ For example, a string can be determined to be within the grammar using the following regular expression (Perl compatible):

.*

Figure 1: Perl-compatible regex specification for SimPL.

2.2 Semantics

The semantics of a programming language are concretely expressed in machine code. This transformation is achieved through the compilation of a programming language. The relationship between the source code of different lagnagues as well as their machine representation can be represented as a simple subcategory of **Set**. Namely, our objects will be the set of source strings for a given programming language with a special object for the set of all machine code representations. Morphisms from source code objects to machine code objects are realized by the process of compilation. If we take every programming language to have a canonical compiler implementation, assume that decompilers do not exist, and consider only one machine architecture, we can view the machine code object as the terminal object of our category.

We will use S_C and S_S to refer to the objects of the C and SimPL languages respectively and M to refer to the terminal object corresponding to machine code representations. $k_C : S_C \rightarrow M$ and $k_S : S_S \rightarrow M$ are morphisms that correspond to the compilation of a programming lagnauge. While both GCC and Clang could be seen as different morphisms from S_C to M we would consider the languages to be distinct since the same source strings correspond to different machine code representations.

In this paper, we focus on simplicity of syntax, and in order to keep other factors constant, we tie the semantics to a well-established reference point, namely C. To express this more succinctly, we will introduce the term *semantic equivalent in C* or SEC. A SimPL source code string corresponds (semantically) to a unique C source code string—this C source code is the SEC of the SimPL source code. We formally define the semantics of SimPL as $k_S = k_C \circ r_S$ where r_S is one component of an isomorphism between semantically equivalent C and SimpPL source code. The components of this isomorphism are $r_C : S_C \rightarrow S_S$ and $r_S : S_S \rightarrow S_C$ such that $r_C \circ r_S = \text{id}_{S_S}$ and $r_S \circ r_C = \text{id}_{S_C}$. This is the illustrated by the commutative shown in Figure 2.

The expressivity of the syntax of C an SimPL may seem too widely disparate to be practical, yet we can actually define the isomorphism between C and SimPL source code. In particular, we will call this isomorphism *radix representation*

¹ See Appendix A for specifications that are not 2 SimPL.

```

#include <stdio.h>

int main() {
    printf("%s\n", "Hello , arXiv!");
    return 0;
}

```

Figure 6: The Canonical SimPL of the SEC shown in Figure 5.

every Unicode character. Thus, the optimal representation will strike a balance between compactness and recognizability of the set of characters used.

“Canonical SimPL,” as we call it, uses a radix 128 representation of an SEC where each digit is rendered as its ASCII equivalent (e.g., 65 as A). An immediate issue seems to arise from the fact that there are 33 unusable values (either non-printable characters or unmapped values) in the ASCII encoding [4]. Yet due to RMM with C, any semantically valid Canonical SimPL source code will only ever correspond to printable ASCII characters. In this way, just as RMM provides us with an isomorphism at the machine-interpretable semantic level, Canonical SimPL provides us with a sort of isomorphism at the human-interpretable level. As an illustration, we have shown the same “Hello, arXiv!” program written in Canonical SimPL in Figure 6.

4 Reference Implementation

In our reference implementation of SimPL, we limited our scope to compiling Canonical SimPL source code. This compilation, in fact, can be done entirely with a typical *nix toolchain. For example, for any given Canonical SimPL program `lorem.sp1`, the compiled binary can be generated as such:

```
cp lorem.sp1 lorem.c && gcc lorem.c -o lorem
```

This represents the GCC dialect of Canonical SimPL; the Clang dialect would be implemented similarly.

Acknowledgements

Special thanks Dr. Bartosz Milewski for informative YouTube lectures on category theory.

References

- [1] In *Esolang*. <https://esolangs.org/wiki/OISC>
- [2] In *Wiki*. *TuringTarpit*
- [3] Guido van Rossum et al. 7. Simple Statements; 7.6. The return statement In *The Python Language Reference* https://docs.python.org/3/reference/simple_stmts.html?highlight=syntaxerror#the-return-statement
- [4] W3Schools. HTML ASCII Reference In *HTML Charsets* https://www.w3schools.com/charsets/ref_html_ascii.asp June 16, 2019.
- [5] Linus Torvalds. Linux kernel. In <https://git.kernel.org/pub/scm/linux/kernel/git/torvalds/linux.git/>. commit hash `0ee4e76937d69128a6a66861ba393ebdc2ffc8a2` (from “master” branch on June 5, 2019).
- [6] Andreas Stefik and Susanna Siebert. 2013. An Empirical Investigation into Programming Language Syntax. *Trans. Comput. Educ.* 13, 4, Article 19 (November 2013), 40 pages. DOI=<http://dx.doi.org/10.1145/2534973>
- [7] Werner Kuich, On the entropy of context-free languages, *Information and Control, Volume 16, Issue 2, 1970, Pages 173-200, ISSN 0019-9958* [https://doi.org/10.1016/S0019-9958\(70\)90105-1](https://doi.org/10.1016/S0019-9958(70)90105-1).

A Earlier SimPL Iterations

SimPL 0 was described by the empty grammar. Though the syntax was very simple, the semantics of the program were static, that is, SimPL 0 could describe one and only one program. We found these semantics to be unreasonably limiting. Thus, we decided that a non-empty grammar would be necessary.

$\langle start \rangle ::= \langle tok \rangle$

Simple 1.0 introduced having at least one rule in the grammar. Although it now conceivable that program could be written according to the grammar (namely a single token), there is still only one possible program. In this way, SimPL 1.0 is equivalent to SimPL 0. We proceeded to Simple 1.1 as such:

$\langle start \rangle ::= \langle expr \rangle$

$\langle expr \rangle ::= \langle tok \rangle \langle expr \rangle$

Although programs can now consist of multiple tokens, the only valid program is in fact one consisting of an infinite string of tokens. In this way, SimPL 1.1 is equivalent to SimPL 1.0. Finally, we added the grammatical option to terminate a multi-token program which we present as SimPL 2 as described in the body of the paper. In short, SimPL 0, 1.0, and 1.1 are too simple but 2 SimPL is not.

B C Source Equivalent of AB

iwiNLHDAAdMgA7hrgfom6BNyYLXJYBoY916TU11FdKL2uFRprQRJ703M8EbXfw3KK99dZE5Aby3GTQGTvLf6LXDr90
AbDXjd367WY47Zra42aAvKMOaW3bA7WjyU1vnhV6LdwUmjCNB9dOq4RhfPnJOKDe9fwMuPg78AMK4UT8VomZGUu9Z
CmeyoWo50GNRVclcxVwVVhuJdj01VuJuyAGZPzsayD8g7FhX6Gug2tHYHDb1NQaoTCjKYpDa4Hx245qRneGLy7pDE
19rW6gtW1dgmQK3trBU7E69jSs6hXPqKBGMADtiaW5i8N5of91JopS7lqEaScxPGrfVxqEdrcfyD8mNyuFicrege
kiTQCVSfcfQW40znWZuBbZCnI8kiZS91pWpMGEo6aydmw0A5A8CWRczpFBCjLvSd6NHIFwXoNkplmBI0yzG3d0Girs
2biZjHylBbZacd4BIp4P21z0p6qmt909K7T1ovEwfeFwtPk01Fm50JJKDCouNgZoBYJL1bEAMuo2C4q4cpwfU5Y0
AfxUvv5tzjCPDxuev6jMM1Pfdzib0SAs9i91RInkqen7MCFIXYdtS8MsZvNfW5ZU0tTKrmUaoV1A1o19pQecjPgFP
SZg4W4TWILFAAuckUjOUh7dmcSNFWE6VLaIhbZVPA9iRmIuj03KKG1L8HaF6LtBXu8EtOm3HPNjQ98u3HemaWwse
VMqKGwBEXwTzksVcBUQRUUZHh9dN9yhs4bF2DCdogb2suzRb5btMBSV1tu1T2E03THzmu6IebEmL7gVvvYmQwOfrk
RTreSj5IoHT5gr13XwH8GB73DIh5114n77CmDzCQCihQJvdrKA1fR1mDPypEai1hmC0qeHYEoG8CpdT5Rah66DWva
ou6hEqrSxQXvxYZ627Mn1heglNz205BgaJI4b1WWM5gs1VALJ5UZJHm0bSEqbizP3G1szq4JDMBijDdJqfH0cD1LX
LsEzi1s2xMyj8LR6KkgGR1XLrbN2RVSfsADadMqsguERxxMUz1wNAL0g6Ev2noQRNJ7pSkQaFVI7yDt3J84dWXY8A
qE9J8jbyVqAbdAersz34UIUuukXMAynFP1PB109PQ7DMSOgn5VDLoHwfbLvc5ngaD6KiST1MLVYVEHjnuLIo3oFAt
RrqbTF1NDnr2ehsGmZOGQ50qjniUAG6oeixbn8AF1Pfh4Feg8zNP2MZQ0jViEar8ZZaPtil4NuZt5NHWhMzjUdIST
ATiijNXUmXxCMhZrxgHs44RHtDLKfn3f7oYGRuSNU8NOnR8M0kHLLbj18IvxtNGmLL8cUovBEquYcDKL5V1vk1wQg
aaP5CjKLoqANY1SsPTrLw5DJKXTqJD1C4u8HzNiJTT8tAHyUVM6uSXuU0hTFpFhNgrwNAwR0IsgYKNUMG4Ak2dY94
vCuh3kPxTXu4ak0MFDtnqfn8zod0Zhj82qiNBcfefq3mskjJTEbrjklRTPo4b1jdznouI6DoFn27CHewGCuzbvfuI
Wne4XfCkEk8VOZxuPh4qSgHLTLBFVMwAU5ATzq06zYyN6jx62RVmWH1UBIqsHM6cMSOjSvTOrP95HTy7d6PdPqrUB
G1M30g4LYqYbYQ01KaDa5vjvBwHio4Sucjbcmbw4N12DqsxaTuVpVq6MHuHQ7aoJxvBFs176j6D3Hz10ngr9aHF8
OtJWR11rqnsgvIPRsdFmktBPKwa5yXE0IYAK9wvhZCws6LL8hZQjEwAlisUm2Lqe4Jj8zAV6ybTa7SKBfcj8vRDjv
ITyckIK79ZXS32PMS7AJTtonE8iEjchXuMLCweB8w0Zwmm4FnPqnb6Ut09tPNZhdoyGu1UBzURVnYw8HLqsT5sw
2h91ugywjhp63sJUCGJh41XFPQ1AjEnhLF2s2dIdMLEZMYJMDzUDLbewuk4xTxH6Wg31sQCFWUyuKVLpi2Q3EK62x
kQeBMJH3X0FSkD0dovkS03TZPBmzDrUmmrxmyjro9LoVNGn11XDZXFVmHeK5ux5cXr7VMF4mW1kf9TfXReLf31B5W
LFELxnRSE8ptpb8TtIHJOIVQaaLMNeBUDdqeJSPQ0i0BXdYasLabb1Bm1016BPJOn1NO31JLnbe6rHmGt0kv1m1F1
4rGjI86vdZE58Qr6Ej4edaF6aQ6XjRyOtNfYLDUJ26Gzm1haMDjToAYyyh8ccIjleBtpw9D21EAeYa0K6ERhfxMXi
qzBvyMrYMjben7uUmcGOCbDYIAWHZbmPu5e0rkXOSjcsn0sQPUCALcBnFs3BMZsA40BFXr68Rq30gRcK6NMxp5HV
9AkTbWcNjGAI0eUSiNSwTgZwnMVixqbCeadJcyW0ftereVahD6Qzzicxtba4z6e8iwuoSiWJ0FJ5yuGeEasxYXec
XDMcky7mCLXsajHAYT7Rafcb18kl0a9AFccQCV9P1AXzGT0pEm7fHC4Jz8A0qDW5I0zAihVcz8vpsT3oijH6UWM9B
3AbSExDFnu8L63dj98d8LxiPgbGoOqEj6sbkzkZfMpe0fbU0HiXDIsqpLhB1MhTPWy8uq0va2JVsCcBGBA661Md8u
BdCwFnPltrLzV1Cydc4BoNEY7mvJwbiRiu6PkcyHi51BHryhSZGacpa2jMBvoF3FKuJFZITGNkuTtELdkGaZiJeD
xKHGOjS8FPOpGR6eTJfNGmqg88YhD8uJv1QM8bdKpwtngU3Uw3o3Ywi3eyAEOYb7jeaAM1CgiMvMSf55HNO6GW6Ce
CUW97LzqBD4LqZ28uzi9rf87aXpb5yV2oTsqbbjeHykRuJw3SGBobfIjAEvbm7mFd8GzNgVD89hVihSMEJseS18zz
Pk4wC0a4bV81AMxbxsFTdMf0ZJ9CqyMRG7WwE53zNN5kiYgT9oRcsHexYDFhbAtq0VQsxyIwCoUjD6K8Zv64WhrzX
LhHqu5iDa6BR5s6WmUtGQfm70Y9My5YUBzi1aLHSRfCRT5MGJ5yCt6NaLsg6iRIFpeMa1i1w7Yjbb48txKBB2Lvw
kKNq1FwUXnbjXIf1mPrUqiPhNR0DLSA7vXmCNe4LQm5AHYphj6jzbl06MnuxmehSKbNVwKWE0paM768xV0Q82ejzH
CP3eUZkrKeC1F0t20Nf6kqW2dC35PqhrmKeD61vuBdYNSGqhcXI1PRTc8TAoEtgxGefzgsW6TFiP7qq4DnhC5yyJd
Cfa6Hq0UBjJLJgw3dR09GB81TXqT0abvXJPSNkg3joVH7RNQyGFLPBvDgVccQygrHGgPURhIt909N8nkp21YAe7u
2CKuhTHXe7ntXjXecWNNAUtRX5IRN7sjVUUhYmpsvBIMPvJEfTEUTm6s7pIOnOpdempLP1N1S7JKszNCcxA1747Ax
Jzs0YUX0PuJTI9qSqKywZ1ou6NI8Y4KgmFqPr0ln05qumlxkELWGLahKG2k1bE5Kswzo210bpk7Ya1lhh083qNqD
RMakqHhoXtTzTqBkX7YqCetW0q4ULn8FgnBbWEMgAwjXXiDbFySezSusRIkPp5Jxa5T1X3TI3jGe5fQk1UewBEDxx
Y41fNjHUHFyKdDPfKcJvygva7Tywb8noeotf8CTrrfQojs3LBjrygeWmu97s31qYg2ZCYddYkC9jiAH70hqCaKBMn
z7T1HJKQYJeT5ZA1w7fI5KqQpAimBWKHEKaDqHBPiQY6dvYwfA78hNdsH7HGQSHYFH9UwiX9Vqu840yCEQSKdctJ
UQfkd6cleB8FSMj7EsjykKKA6koioHTZduyUfiAgJffAasDeGXdekD6SlrZU3phWU5QgnrJUvEZakAAQgr0iTvnd

hHa0NS4DMrZNOzOPDoQ1gYj70ZKisvKmZ25cfwfh1F0qkHrQAaqojHz2b1yJOMgCc1YuybMiRgrBjT1Q9GZnJVgqB
cyWRJ9CryzMT6TP4UiYxi5je29vjnevXrwqPjkKftYk1UzbPX8Tbr4bDv25vMGycQEsspOB3PNeOrqaIcRtYM3AirB
UROVOBzI3AUOUJI711EaCU9y6NwJuhKWUjVAiTA6ncb9vg20k30h9ojCnmV15aEiPLqixjeJtOYg9pHCj124INZUH
jUBEFeb8yTIJFufHxQVB1XMwZFAQLFk48t4p16e6E2kASqggtdoxfyv71AD83bQZ3gMJefcvAjM6CmghyPjMipTY
XhscKk4dTFYFLIwqFINGWUjQjYwSoAL00qLQFZnyWv1BjIV7enDf3kEQXA31NFuqfLdpVxB0IYbrsuSWtF1VI5gti
F29VuYarLAMsrnD4vHvxLxvClfJARmEnvdpIWgaNAoI8vYFoanQgsYUL5axFHSGdZclI6hXAI9WY7fC2DVPOXI8y
rc0c1HIuSSBkMGEgnZmIGDwBr8Qd1EIoIJqT0jsbxPBLiwj3UwCm0v0m8sYwOdwvfZZOmOzLChSPoHBiWcywmBfkQ
oLLQq2GXx6G9vBQzv7SSgWrSqKR98g8JUXto1uDf03DcNpW93UPBzoltPtFkXrIW6RdLb3FnciZAWa0qMNEFWtjJ
jMkMkZgK7pSjJm3jyyHkR2exTzvCtVnIAdlJbcRyKRhk868VLMh3CziVVA82QeN7hKVZUY1gjl1AykCgTnFK1G5ZP
ArnyzopJJzjd0wlbSilRNVLfjjNLBtfsldqir010nQfC6NdBwUEBQKwx0aNXBZY9ZtSmK70icMZvxL4zynYOYxy
BnpeUBD3iRNxp1o4NadZGmoy9jVgCyastLX2NKBSkZ02dtvxCsVOM5FmNXQ7cPshl9xPCrFzY6CdXFai1aZ8NhU6y
JGcRaPiRTY4L21bFg6YtPaUdxENHfEXqAgzZDwUuaGqvfGDKbLEntXKAhuOrFVe7kL6YhlwBhZOGg2XGDHdQGJO08
e51Mz6LeqfasIfXJpanrFfx5MbItGrygey033Q0q73yDK8HMsT45ZCGmC88a74b1bczxrAFpItkks6WwQXPuKiRx
iaaqqhZaa98or7h8q08jAgEBWIZkqpcMSoMIOJSGfI5qTCMM7xkwKdgnU916NYSur5uDeVWh8j1N6GfRyGpuXF6e
gYIOPnAEUC95wxWYK78TEmfhLdNBvZ0fknAM0640R7EWR4xyyCquBUecqvI4OrM6eWgD5A92M3Yeuu8nKcfvBG9jt
1NXwKiRF80MAG3UVrhGvodPY1yCZvGgoLYZwW002Pt2wPpDMw1I110HVB9WuLFSJsnmAUJxklU068c1AUK80y8MH
7wYsIR8BIIiNyaYmgVMt2wUrZyU4qi7sPZQcvBs19vRdToqpEANv5eoNUtPZiB6ejc951XiERnZUWuKUSRLMpJLev
YbP9usKbSQI5Exab0mHUT013J3yL5q1rnuCtaC97fw0zvN7nSNIAPykXEKCU8sbWCqdxYldqIOr6m8IrRGG9MCFt
mMyGI6EKBV0qJZaXypJUyhyCB9eD66aXhnhVLCYMDZakAKajgwbtTR4088tCI4s4SGXbf9yKvbeVw8qhc1DC2
m3JalkjstvDn1wUJJ41JHL9zBH54GwxGS9jrmavjElJyEEBxjHsC7hcsTNLfwBNP0oFVPUduf0UERNgYP6fWKOQwnI
jYkmVFN5p0lmcDqRxmngZnj7ksXEmWwT0eJ27uIm5ICAt4ieZHZA8r7VjzmPkg91j1Q0Zizf100QTJ3xhuo1QjB
qSpyE8ZTqpHVzqxXiTG1BuU34gNmhp3rbTAt0M3At2mPBAXoeasYkbqzUky7ptuR63Q0Uo0TJaKqre2XeEbI6tU
TDXUelK8WF5xF1Uc5In07I4MGRcrlZsqIzqpbVyWsZxdOhZuzeM109eRAU7ZkXWuhkvTBsmXGpisoAqm96CS8oRYC
YVgEFfLd1whEgD6wyiKkNr4X6v2nYiTY6efOeLXReVp6KLi8aI4A4wp4bp0db4YmJ40zVtUuLME8SIuQwFVVMFLFQS
tGuJsNep8LXgBMQFun37v4ZckJCE7Joph9RPOpQroJD1BZLE0kh0aktzQtAuqtQps0lyZwx4rpy6Eedco61uA96kf
ZQyKbGU6uQzJTjpE0aLP18S3ETYHPORt1s8LFCKrEA5sJRCDJhWhXWqVkygKANDZzcUPnfahMOpJggADtk317B5Hy
4o8tcrqLgh6DTbKWFx0hRkDRB4boBIZz2Gcx0ZbvU0tKzNqgjWwMy5w1d5phZQEFkpo2vBYHLCPtNcsSt2L1E1i
1bIb0QnKZJiM1W037JVrP9X3XC7G04F9MtpIVZrlnLoHxNRwnCdPedlqH3F0xSRytqjIrkNSwhQ7EjboJaoqrGgY7
dHaWnvqGP5EjxwjiiHsSwXpNVJ1yfQmg2CkFWWW10cir4WZKKWxiJihcNgHl7GxwJjVyg48gPbB6yehXAodwDHBXJ
kiJonlF0mT4iyngSpXSiYApk1xqekI5vCfKQP1vqTG73QhQuLB5X0mc3FoAyMyYovjgUm21dMuLxyheCY8Ek3CKED
BjGOXdyd57qSmJ8fRzUMEFwrLKIG0LFFKQUR27wyy59Wm1mBe3G008622ktZPrqct2Jnw8cf7UkeAGbwIxBhN1Bi
yofU7udkPHughatJt8ShS8NLsDS7UevvesR3PBFs2qnsG2IXB40429AvSFG7bE4A0oxHGU2swLMwgh4eXXIAhIkHa
I7SfYbJ20MoX4SpJFFe2eX9HTUVVvhsSW5KgyDLFHSsKcnsdj3JMXRb1TMzHZN7UFMFNDmqRcnvI1R9n7ZsIS8EYA
2iSY6MXhT1Dh4mvN7tUpOUZFSbIfS2LEUSHqilrAMU6fdkqT1GvwhluCYTj8dmwLYLjaoUekUVRrf7yht2BZsDj
Rl1m02sriN90x1glHvgTmM6PUEZtGQevNt9gL9t9yvQI18ahoXOCwzebYyztQYUsUi9gkmu7YjMAOPXhri1WV86c
2NMh1SBgGsL05xH1dqgJBTsaddrPps646paji90EKZeY5n0WtptywgOpsgF7WlobAGFSMOAfUyavgp7DpNgfmmvbVL
RY1viz05B0uqGTbxZD1tbsd0xe0ZG1GyfkMuUgEml7qQV5uk89co5x645nW8fmA2R5yBhOgcoF2f33ZuxZrCKLVv
wBTiwugQ5aMtfOmdK48MZommHdMvhLLYmIDHUdYtWLOkNDfne8z1sqmm310a6pLhzZgzAFZV8NRiIXQ0p8x8wUC3j
0kfgb50WFG5V42Nk4CJHkuZTvmteP7I00gvGsYMc5IxbiQe1b9YzYqhZnMzjye37JHaiVa0NCsGDSME59br0txs3
nYM5hIOWqK2ITUENZcROA9JU1ASVseFqKlyvxLUx8K233Wa9bHxp1qqYm51T4iK71NvJi0TpkFAYzh8M2Y11o8K9g
OMR6cwkpafmXirUlDHCY6ebH8XI3R3CZz2Q0WxXhmKfW0zywxRRADtei2m0GcwocundAVTmyfPCn9YFeM0ePE4bWy
a6MTVYjUPWdtVz2VHbPvat2I4kIh85RmxFPnOJrRwXQRldJtqQ2Xh8IcNyxyDAdSWJjk0QBf8E9VpnsPJwPg5snVI
y62T1SC8Hx36kUH1QQsiL1l1igffGoQh0p0qSxUL3AivTBWh270j4YJCC51zxl1B04c1R4vqAh11aQy7r6PswD7K4t
B80WbtzqBpnJRyIHMGcgCOV4gEChjVpdUL9WQZmW0JytMUypw6qPWyh8t3K9KB25WE9GGIr1TLjOnaxX5NMUruwh8
NWdtaVJvICjBDL1IphOp6nZLLKD9x41uwm2sYy7RehFXe8U4ajyIwfcXyADIZ0JvOKqz3bYov4JrqvA0o3HODRoBs
Newo4hHHQecrh4ScYWH7MhKbZVW0qi2riRskNqOvZ5MrMnTBjluT6jyJN5HNptTV17phE3qBYqRIBQM0zIQy6jeV
7kcfbsfS84ANMG51Ng7Tg3a36QaKrF4RR9w3QqyxwygRHGARj1bWu4694hodqMLwUTTyGLJqmsaa89JdS38fYHwFs
raUOSJwNqyyZ0igEVz2HxTNo6rnjDtkntvUGCzVN9o2fFyB5L1F7QZZi2n0T3n7ajQXjZQbBrLF4AgfpCp17dM2z
p3geeEz7ogmRr7A597GaKmkDEMZOiu4wHw3G5Ysf14EB9gfgzRSypCRmdtKPlmESjCrXMcZpPKcez1Q6J1Ep8Tk0Lf
AtGL7tNhZpLy5Xqpl4sxPPwytyzmiyqA5fvemZ6RZYz9WjpnRL8J1EJhcH60vf3ravGfqDScps3WBG2HUQxnuSBw
yqlTinZ46spT42pTZB3ZFgwm4HdORcs7mwYjykr5qKYzQzCuhgFLyDeW3QVp7zh2Sho1vHdMTbekK39A8t0Ynb5zX
9TxQaMqNdQtXjusMAIHfnnlyUPvs1pPjOVMSkzW5ewrWBO8YcTCyXqAbRW8Ad7gnG09EG611yipglH4W9DhB7ka7
qvEtcUjwQ0fVJhCALK062Ph8mqCGHMBb0K61yDq8YgwnnsGffCRvOulDef



CONFIDENTIAL COMMITTEE MATERIALS

SIGBOVIK'20 3-Blind Paper Review

Paper 12: Formulating the syntactically simplest programming language

Reviewer: Wannabe

Rating: Potential breakthrough

**Confidence: I couldn't make heads or tails of it, but something
this complex must surely be terribly clever**

Insightful framing of a classic problem in a completely novel way

Type-directed decompilation of shell scripts

Spencer Baugh
University of Carcosa
Carcaso, Hyades
first.last@gmail.com

Dougal Pugson
Pugson's C++ Crypt LLC
New York, USA
dougalpugson@gmail.com

Abstract

Maintenance shell programmers are often faced with inscrutable shell scripts without human-readable source code. We apply techniques pioneered by the type-directed partial evaluation community to create a decompiler which can take an executable shell script and recover its original source code. This technique has surprising generality, and our decompiler can also be used as a pretty-printer, or in general, as a compiler from any language into shell.

CCS Concepts • **Software and its engineering** → **Scripting languages; Compilers; Software maintenance tools; Theory of computation** → **Type theory.**

Keywords Partial evaluation, type systems, shell scripting

ACM Reference Format:

Spencer Baugh and Dougal Pugson. 2020. Type-directed decompilation of shell scripts. In *Proceedings of SIGBOVIK (SIGBOVIK 2020)*. ACM, New York, NY, USA, 3 pages. https://doi.org/10.475/123_4

1 Introduction

Among its many beneficial properties, shell has a unique feature: The language automatically compiles itself as it is written. Immediately after a shell script is typed into a computer and saved into a file, it is transformed into a compiled form which is unreadable by humans.¹ Such a script can be immediately used for all your most important financial data, medical procedures, etc., while you are safe in the knowledge that no-one can read your important proprietary shell scripts.

Unfortunately, sometimes such scripts might exhibit minor bugs. Since these executable files that are leftover from the process of shell scripting are unreadable garbage, maintenance programmers are often forced to rewrite from scratch. Sometimes, very brave programmers will try open one of

¹Use of the authors' previous work on delimited continuations in bash, [1], seems to accelerate this process.

Permission to make digital or hard copies of part or all of this work for personal or classroom use is granted without fee provided that copies are not made or distributed for profit or commercial advantage and that copies bear this notice and the full citation on the first page. Copyrights for third-party components of this work must be honored. For all other uses, contact the owner/author(s).

SIGBOVIK 2020, April 2020, Pittsburgh, PA USA

© 2020 Copyright held by the owner/author(s).

ACM ISBN 123-4567-24-567/08/06.

https://doi.org/10.475/123_4

these old, buggy "shell script files", but generally they are instantly turned to stone upon seeing the inscrutable contents. And since shell is so convenient, typically the original programmer is long gone - probably retired early.

Our contribution in this paper is a decompiler for these files, which is able to recover the original source code. This source code can then be viewed by the maintenance programmer, to help them reimplement the script in their non-shell language of choice.

As outlined in our previous work, [1], the Unix shell is closely historically related to functional programming. Thus it should be no surprise that we are able to transplant techniques from the functional programming community, to the shell, in the tradition of [4].

In this case, we use partial evaluation techniques to achieve our goal. As described in [3], as citing [2], as blowing the minds of undergrads everywhere, sufficiently general partial evaluation techniques can be applied to "reify" a compiled program and recover the program source code, under the constraints that the program 1. has a type and 2. terminates. Pretty easy constraints, I think we can make that happen for bash!

As a more approachable introduction (note that "more approachable" doesn't mean "approachable"), these techniques can be compared to tagless-final-style techniques. Decompilation of a typed, compiled program is essentially identical to pretty-printing of a tagless-final-style term. The magic is that any typed, closed program can be treated as a TFS term.

Our paper is organized in some number of sections. Section 1 contains an introduction and a description of the organization of the paper. Section 2 contains an exploration of the requirements for applying these techniques, and establishes their firm grounding in theory. Section 3 demonstrates several applications. Section 4 gives an overview of the implementation. Section 5 concludes the paper, discusses future work, and affirms that this was the right thing to do.

2 Theory

As mentioned above and in [2], we have two requirements to apply type-directed partial evaluation: The program must be typed and must terminate.

2.1 Typed

What is the type of a shell script? Well, a shell script takes the PATH environment variable, and runs commands (identified by strings) out of PATH, each of which has some side effects.

A shell script doesn't return anything, it just has side effects, so let's say that its output type is *unit*.

So that means a shell script has type $path \rightarrow unit$, where $path$ is $(str, [str]) \rightarrow unit$.

Then in total, a shell script has type $((str, [str]) \rightarrow unit) \rightarrow unit$.

We can confirm this is correct by applying double negation elimination² which shows us that shell scripts have type $(str, [str])$. This is correct because a shell script is indeed a bunch of strings.

Let's be a little more specific with our type, though, and model each executable as a function. So then the type of `PATH` is $(str \rightarrow ([str] \rightarrow unit))$, and the type of a shell script is then $(str \rightarrow ([str] \rightarrow unit)) \rightarrow unit$

For now, just think of a shell script as taking `PATH` and running commands out of it.

2.2 Termination

Termination, on the other hand, is a much harder problem than assigning a strict static type to shell scripts. This is because of the presence of the dreaded D-wait in Unix. A process can get into an uninterruptible state when making a filesystem request, and just hang forever, ignoring all signals, including SIGKILL. This is really annoying for people developing filesystems, which we had to do for this paper, so we want to complain about it here.

Nevertheless, if the program hangs, this issue can be solved by simply mashing Ctrl-C. Even D-wait can be solved by throwing the computer out the window (assuming a sufficiently portable computer, and great enough height for it to be destroyed on impact).

So termination is ultimately not a problem either.

2.3 Background

In brief, the principle of the technique we will be applying is this: A closed, abstract function, which takes in other functions and combines them through application in some way to eventually return a result, can be passed functions which, instead of performing actual operations and returning real results, take ASTs and return ASTs.

For example, a parameter with type $(a, a) \rightarrow a$, which might normally be addition of two integers or something, can be passed at the specific type $(ast, ast) \rightarrow ast$, and be implemented as $\lambda x. \lambda y. Plus(x, y)$ where *Plus* is some data-type constructor.

A shell script's single argument (in our model) is the `PATH` environment variable.³ We will pass in a `PATH` which, when an executable name is looked up in it, returns the executables (functions) of our choice. These executables will in turn,

when executed, construct an AST instead of actually doing anything.

3 Applications

Let's demonstrate our tool before getting to the actually interesting part.

3.1 Decompiling bash

Suppose we save the following shell script to a file and mark it executable, which instantaneously makes it unreadable.

```
ls ; which ls
stat /
foo | bar
```

Nevertheless our decompiler can run on the script and produces the following output:

```
ls
which ls
stat /
foo | bar
```

As you can see, our decompiler even pretty-prints the shell script.

3.2 Decompiling arbitrary executables

It also works on C programs, and in general, arbitrary executables. We can compile the following normal C program, and run our decompiler on it.

```
int main() {
    int rc;
    rc = fork();
    if (rc == 0) {
        execlp("foo",
              "foo", "bar", "baz", NULL);
    } else { wait(NULL); }
    rc = fork();
    if (rc == 0) {
        execlp("whatever",
              "whatever", "quux", NULL);
    } else { wait(NULL); }
    return 0;
}
```

And we get the following shell script out:

```
foo bar baz
whatever quux
Useful!
```

3.3 Optimizing decompiler

Our decompiler is so advanced that it in fact transparently applies optimizations in the process of decompilation. Consider the following C program:

²DNE is an axiom because this paper is unintuitive.

³This has sufficiently abstract types, since everything is a string, so we don't know what anything is.

```
int main() {
    printf("hello _world\n");
}
```

This program decompiles to the following shell script:

Our decompiler correctly recognizes that this program, since it doesn't execute any other programs from the filesystem, is in fact utterly worthless, and optimizes it away to nothing.

4 Implementation

Much to our surprise, we actually implemented this.

We have implemented a filesystem (using FUSE), which pretends to have any possible executable you want. We point the shell script at this filesystem using PATH, and each time the shell script goes to run a command, it instead runs a stub under our control. Using some real technology we developed earlier and just thought it would be funny to use for this, this stub connects back to the filesystem server, where our decompiler is able to query its argv, stat its stdin/out/err, and tell it to exit with a specific exit code.

To mount the filesystem without requiring privileges or setuid executables, we use a user namespace and mount namespace, and run the script inside those namespaces.

After the shell script finishes execution, we reconstruct its source code from the trace of executed commands using a highly advanced for loop.

Note that this doesn't use "LD_PRELOAD" or strace, so it can even be used on statically linked, setuid shell scripts. There are lots of those!

The code is on Github at <https://github.com/catern/rsyscall/tree/master/research/sigbovik2020>.

5 Conclusion

5.1 Future work

5.1.1 Support for niche shell features

There are some niche, minor features of the shell language which are not supported by our decompiler, such as "if" and "while". As any true shell programmer uses "xargs" instead, which our framework would decompile just fine, this isn't a problem.

Nevertheless it might be nice to figure out some ridiculous hack that would allow such features (and shell builtins in general) to be visible to our decompiler.

Maybe we could execute the shell script multiple times, returning different exit codes from commands different times, and thereby get a collection of traces through the control flow graph, which we could then piece back together. But this is beginning to sound like real work.

5.2 Conclusion conclusion

In conclusion, we hope that this tool proves useful for maintenance shell programmers, who will finally have a way to read

those shell scripts that they always complain are unreadable. Hopefully this will increase their productivity, massively increase global GDP, and cause my 401K to recover all the value it lost due to the coronavirus.

References

- [1] BAUGH, S. bashcc: Multi-prompt one-shot delimited continuations for bash. In *Proceedings of SIGBOVIK 2018* (Pittsburgh, Pennsylvania, 2018), Association for Computational Heresy, pp. 161–164.
- [2] DANVY, O. Type-directed partial evaluation. In *Partial Evaluation* (Berlin, Heidelberg, 1999), J. Hatcliff, T. Æ. Mogensen, and P. Thiemann, Eds., Springer Berlin Heidelberg, pp. 367–411.
- [3] KISELYOV, O. *Typed Tagless Final Interpreters*. Springer Berlin Heidelberg, Berlin, Heidelberg, 2012, pp. 130–174.
- [4] SHELLEY, M. W. *Frankenstein: or The modern prometheus*. Lackington, Hughes, Harding, Mavor, and Jones, 1818.

Verified Proof of P=NP in the Silence Theorem Prover Language

Matias Scharager

March 2020

1 Abstract

Godel's Incompleteness Theorem has for quite a long time made people aware that it is not possible to design a sound, complete and consistent language that encapsulates all the natural numbers. Programming languages that care about type theory in their construction usually try to devise theorems on things that seem like the natural numbers and exhibit some properties of them, but never fully encapsulate all of mathematics. There will always be a theorem left unproven in these languages.

However, the common approach these languages have is that they neglect completeness. Instead of this, the Silence programming language implemented in this paper goes beyond this idea and chooses to neglect soundness. This allows for a language capable of proving any mathematical statement. We then proceed to add in as many formalisms as necessary to express the $P = NP$ problem and prove it.

2 Booleans

Our booleans consist of 3 distinct terms each of type **Bool**. **want** represents the true case. **don't want** represents the false case. And of course, **might want** is indecisive and doesn't know which one to pick.

$$\begin{array}{c}
 \overline{\Gamma \vdash \mathbf{want} : \mathbf{Bool}} \quad \overline{\mathbf{want} \text{ val}} \quad \overline{\Gamma \vdash \mathbf{don't want} : \mathbf{Bool}} \quad \overline{\mathbf{don't want} \text{ val}} \quad \overline{\Gamma \vdash \mathbf{might want} : \mathbf{Bool}} \\
 \overline{\mathbf{might want} \longrightarrow \mathbf{might want}} \quad \overline{\frac{B \longrightarrow B'}{\mathbf{I} B a \text{ more than } b \longrightarrow \mathbf{I} B' a \text{ more than } b}} \quad \overline{\mathbf{I} \text{ want } a \text{ more than } b \longrightarrow a} \\
 \overline{\mathbf{I} \text{ don't want } a \text{ more than } b \longrightarrow b}
 \end{array}$$

3 Natural Numbers

It is generally a good thing to have some notion of numbers in a programming language. The reason behind this is that people generally associate the word computation as being something done on numbers and so having numbers in a programming language is a must. The following is the statics and dynamics for an encoding of the natural numbers in Silence.

$$\begin{array}{c}
 \overline{\Gamma \vdash \mathbf{7} : \mathbf{Nat}} \quad \overline{\mathbf{7} \text{ val}} \quad \overline{\frac{\Gamma \vdash x : \mathbf{Nat}}{\Gamma \vdash \mathbf{succcc}(x) : \mathbf{Nat}}} \quad \overline{\frac{x \text{ val}}{\mathbf{succcc}(x) \text{ val}}} \quad \overline{\frac{\Gamma \vdash N : \mathbf{Nat} \quad \Gamma \vdash a : A \quad \Gamma, x : A \vdash b : A}{\Gamma \vdash \mathbf{recNat}(N; a; x.b) : A}} \\
 \overline{\frac{N \longrightarrow N'}{\mathbf{recNat}(N; a; x.b) \longrightarrow \mathbf{recNat}(N'; a; x.b)}} \quad \overline{\mathbf{recNat}(\mathbf{7}; a; x.b) \longrightarrow a} \\
 \overline{\mathbf{recNat}(\mathbf{succcc}(N); a; x.b) \longrightarrow [\mathbf{recNat}(N; a; x.b)/x]b}
 \end{array}$$

As such, we now have Heyting Arithmetic. Notice to avoid arguments as to whether the natural numbers begin at 0 or 1, we have opted to start at 7.

4 Functions

All functions are fun, so we didn't want to leave any of them out except we only really want to implement three of them. Silence has fixed point recursive functions and non-recursive functions. It has dependent type functions as well.

$$\begin{array}{c}
\frac{\Gamma, a : A \vdash b : B}{\Gamma \vdash \mathbf{fn} \ a : A \Rightarrow b : A \rightarrow B} \quad \frac{\Gamma \vdash f : A \rightarrow B \quad \Gamma \vdash x : A}{\Gamma \vdash f \ x : B} \quad \frac{}{\mathbf{fn} \ a : A \Rightarrow b \ \mathbf{val}} \quad \frac{f \rightarrow f'}{f \ x \rightarrow f' \ x} \quad \frac{x \rightarrow x'}{f \ x \rightarrow f \ x'} \\
\frac{}{\mathbf{fn} \ x : A \Rightarrow b \ \mathbf{val}} \quad \frac{a \ \mathbf{val}}{(\mathbf{fn} \ x : A \Rightarrow b) \ a \rightarrow [a/x]b} \quad \frac{\Gamma, a : A, f : A \rightarrow B \vdash b : B}{\Gamma \vdash \mathbf{fun} \ f \ (a : A) \Rightarrow b : A \rightarrow B} \\
\frac{}{\mathbf{fun} \ f \ (a : A) \Rightarrow b \rightarrow \mathbf{fn} \ a : A \Rightarrow [(\mathbf{fun} \ f \ (a : A) \Rightarrow b)/f]b} \quad \frac{\Gamma, a : A \vdash b : B(a)}{\Gamma \vdash \Lambda a : A. b : \forall a : A. B(a)} \\
\frac{\Gamma \vdash f : \forall a : A. B \quad \Gamma \vdash x : A}{\Gamma \vdash f \ x : [x/a]} \quad \frac{}{(\Lambda a : A. b) \ x \rightarrow [x/a]b}
\end{array}$$

5 Tuples

$$\begin{array}{c}
\frac{\Gamma \vdash a : A \quad \Gamma \vdash b : B}{\Gamma \vdash (a, b) : A \wedge B} \quad \frac{\Gamma \vdash M : A \wedge B}{\Gamma \vdash M \cdot \mathbf{1} : A} \quad \frac{\Gamma \vdash M : A \wedge B}{\Gamma \vdash M \cdot \mathbf{r} : B} \quad \frac{a \ \mathbf{val} \quad b \ \mathbf{val}}{(a, b) \ \mathbf{val}} \quad \frac{a \rightarrow a'}{(a, b) \rightarrow (a', b)} \quad \frac{b \rightarrow b'}{(a, b) \rightarrow (a, b')} \\
\frac{M \rightarrow M'}{M \cdot \mathbf{1} \rightarrow M' \cdot \mathbf{1}} \quad \frac{}{(a, b) \cdot \mathbf{1} \rightarrow a} \quad \frac{M \rightarrow M'}{M \cdot \mathbf{r} \rightarrow M' \cdot \mathbf{r}} \quad \frac{}{(a, b) \cdot \mathbf{r} \rightarrow b}
\end{array}$$

6 Sums

$$\begin{array}{c}
\frac{\Gamma \vdash a : A}{\Gamma \vdash \mathbf{inl}(A \vee B, a) : A \vee B} \quad \frac{a \ \mathbf{val}}{\mathbf{inl}(A \vee B, a) \ \mathbf{val}} \quad \frac{M \rightarrow M'}{\mathbf{inl}(A \vee B, M) \rightarrow \mathbf{inl}(A \vee B, M')} \quad \frac{\Gamma \vdash b : B}{\Gamma \vdash \mathbf{inr}(A \vee B, b) : A \vee B} \\
\frac{b \ \mathbf{val}}{\mathbf{inr}(A \vee B, b) \ \mathbf{val}} \quad \frac{M \rightarrow M'}{\mathbf{inr}(A \vee B, M) \rightarrow \mathbf{inr}(A \vee B, M')} \quad \frac{\Gamma \vdash M : A \vee B \quad \Gamma, x : A \vdash a : C \quad \Gamma, x : B \vdash b : C}{\Gamma \vdash \mathbf{case}(M; x.a; y.b) : C} \\
\frac{M \rightarrow M'}{\mathbf{case}(M; x.a; y.b) \rightarrow \mathbf{case}(M'; x.a; y.b)} \quad \frac{}{\mathbf{case}(\mathbf{inl}(A \vee B, n); x.a; y.b) \rightarrow [n/x]a} \\
\frac{}{\mathbf{case}(\mathbf{inr}(A \vee B, n); x.a; y.b) \rightarrow [n/y]b}
\end{array}$$

7 Sigmas

$$\begin{array}{c}
\frac{\Gamma \vdash a : A \quad \Gamma \vdash b : B[a/x]}{\Gamma \vdash \langle a, x.b \rangle : \exists x : A. B(x)} \quad \frac{\Gamma \vdash M : \exists x : A. B(x)}{\Gamma \vdash M \cdot \mathbf{1} : A} \quad \frac{\Gamma \vdash M : \exists x : A. B(x)}{\Gamma \vdash M \cdot \mathbf{r} : B[M \cdot \mathbf{1}/x]} \quad \frac{a \ \mathbf{val} \quad b \ \mathbf{val}}{\langle a, x.b \rangle \ \mathbf{val}} \quad \frac{a \rightarrow a'}{\langle a, x.b \rangle \rightarrow \langle a', x.b \rangle} \\
\frac{b \rightarrow b'}{\langle a, x.b \rangle \rightarrow \langle a, x.b' \rangle} \quad \frac{M \rightarrow M'}{M \cdot \mathbf{1} \rightarrow M' \cdot \mathbf{1}} \quad \frac{}{\langle a, x.b \rangle \cdot \mathbf{1} \rightarrow a} \quad \frac{M \rightarrow M'}{M \cdot \mathbf{r} \rightarrow M' \cdot \mathbf{r}} \quad \frac{}{\langle a, x.b \rangle \cdot \mathbf{r} \rightarrow b[a/x]}
\end{array}$$

8 Unit and Ununit

This is the most significant achievement of this paper. While unit exists in most programming languages, ununit is a novel new idea that creates the unsoundness feature of Silence. Note that if tilt your head while viewing the typing judgement for ununit, it looks like a person with a halo on their head.

$$\frac{}{\Gamma \vdash () : \mathbf{1}} \quad \frac{}{() \ \mathbf{val}} \quad \frac{}{\Gamma \vdash \langle \rangle : -\mathbf{1}} \quad \frac{}{\langle \rangle \ \mathbf{val}} \quad \frac{\Gamma \vdash x : -\mathbf{1} \quad \Gamma \vdash y : \mathbf{1}}{\Gamma \vdash x \ y : A} \quad \frac{x \rightarrow x'}{x \ y \rightarrow x' \ y} \quad \frac{y \rightarrow y'}{x \ y \rightarrow x \ y'} \quad \frac{}{\langle \rangle () \ \mathbf{val}}$$

9 IO Behavior

True to its name, Silence has no IO behavior. It can neither read from the input nor write to the output. We have purely functional behavior as there is also no imperative computations.

12 Conclusion of P=NP

The following type is representative in some way of the classical $P = NP$ problem. As the type states for all verifiers, if that verifier runs in polynomial time and there exists a valid solution that makes the verifier return true, we have a valid algorithm that runs in polynomial time and is able to find a solution.

$$\begin{aligned} \forall \text{verifier} : \mathbf{Nat} \rightarrow \mathbf{Bool}. ((\forall x : \mathbf{Nat}. \text{verifier } \mathbf{zooms\ through\ } x) \rightarrow (\exists x : \mathbf{Nat}. \text{verifier } x)) \\ \rightarrow (\exists \text{algo} : () \rightarrow \mathbf{Nat}. (\text{algo } \mathbf{zooms\ through\ } () \wedge \text{verifier}(\text{algo}())))) \end{aligned}$$

Notice that the following is a valid term of this type and thus is a proof of P=NP

$\Lambda \text{Easy} : \mathbf{Nat} \rightarrow \mathbf{Bool}.$

fn $\text{as} : \forall x : \mathbf{Nat}. \text{Easy } \mathbf{zooms\ through\ } x \Rightarrow$

fn $\text{pie} : \exists x : \mathbf{Nat}. \text{Easy } x \Rightarrow \langle \rangle()$

13 Future Goals

Much like most published programming languages, there currently exists no working implementation of Silence. The following is a proposed compilation translation into assembly

$$\overline{\cdot \vdash e : \tau \rightsquigarrow \mathbf{nop}}$$

Note that the translated program results in the same IO behavior as the original program, so we can very efficiently express the content of the language.

Systems

11 SIGBOVIK '75 technical note: Conditional move for shell script acceleration

Dr. Jim McCann, Dr. Tom Murphy VII

Keywords: cond-, itional, move

12 NaN-gate synthesis and hardware deceleration

Cassie Jones

Keywords: hardware deceleration, hardware synthesis, electronic design automation, IEEE-754, NaN-gates, cat meme

13 hbc: A celebration of undefined behavior

Andrew Benson

Keywords: compilers, undefined behavior, Bash misuse, computer music, Principles of Imperative Computation

Dr. Jim McCann
IX@TCHOW-ARPA

Dr. Tom Murphy VII
TOM7@T7-ARPA

Abstract

One of the most effective programming interfaces for modern microprocessing computers is the command-line interpreter, or shell. Shell scripts provide a high-level abstraction of the operations of a microprocessor, making them an appealing alternative to hand-translated machine code or so-called "macro assembly languages". Unfortunately, shell programs are also significantly slower than their assembly counterparts. One potential source of this slow-down is branch misprediction. In this paper we show how to address this drawback by adding predicated execution to the shell.

1 Introduction

One common trend in computing as of late has been the migration of features from CISC instruction sets developed by DEC, Intel, and other captains of industry to the relatively underserved "high level" languages community, who generally focus on simpler and less modern operations. We continue this tradition by showing how to bring the advantages of predicated execution to shell scripting.

Predicated execution allows processors to avoid the root cause of branch prediction stalls: branches. Instead, instructions are provided which can check one or more predicate registers and effectively become no-ops if the registers are not set. These so-called predicated instructions are always executed, so no pipeline stalls need to be included while the processor decides which instruction needs to be fetched next.

Predicated execution for the shell provides a similar benefit -- expensive branch predictions can be avoided, resulting in tremendous speed-ups (up to 100x in our tests).

2 Implementation

The minimal instruction needed for conditional execution on a modern five-stage pipelined cpu is conditional move. This instruction moves a result from one register to another if a tertiary condition register is set.

In shell scripting, where files are the obvious equivalent of registers, the semantics are clear:

Usage:

```
cmv <file1> <file2>1
```

Rename file1 to file2, if the condition register is set.

But what is the condition register? We explored two choices of condition register -- the exit value of the previous command, which leaves us with a bit of a problem, since this value is not readily available to a process; and the processor's cf^2 register, which is also not readily available to shell scripts.

2-1 The 'csh' shell

The first method we propose to allow easy access to the return value of the previous command is to run a modified shell -- which we dub the 'csh' shell -- that stores the return value of the previous command into an environment variable when invoking a subprocess.

In our implementation (Figure A), the variable is called 'DOLLAR-SIGN-QUESTIONMARK-ALL-SPELLED-OUT' for obvious reasons.

2-2 The 'c' utility

While it would be straightforward to implement, exclusively, a conditional move

1. Note the use of AT&T assembly syntax, where the source operand comes before the destination operand.
2. "condition flag"

```

diff --git a/src/exec.c b/src/exec.c
index 87354d4..7552f8d 100644
--- a/src/exec.c
+++ b/src/exec.c
@@ -112,6 +112,8 @@ shellexec(char **argv, const char *path, int idx)
     char **envp;
     int exerrno;

+     /* pass exit status of last process to executed program */
+     setvarint("DOLLARSIGN_QUESTIONMARK_ALL_SPELLED_OUT", exitstatus, VEXPORT);
     envp = environment();
     if (strchr(argv[0], '/') != NULL) {
         tryexec(argv[0], argv, envp);

```

Figure A: This patch for <https://git.kernel.org/pub/scm/utils/dash/dash.git/> creates a shell that stuffs the return value of the previous command into an appropriately-named environment variable.

utility; we instead embraced the high-level nature of shell scripting by creating a general purpose predication utility, ‘c’, which (when called as ‘cNNN ...’) will run ‘NNN ...’ when the proper predicate values are set. Since this utility’s behavior is based on its name, one can create a new instance of it by simply creating an inode link. For example, to make a conditional version of /bin/sh:

```
ln -s /bin/c /bin/csh3
```

Our implementation of ‘c’ (see <https://github.com/ixchow/c/blob/master/c.c>) is written, naturally, in C, and is built to support both the shell-level approach discussed above and the kernel-level approach discussed below.

3 Evaluation

In order to evaluate the performance gains of conditional evaluation, we compared conditional and traditional versions of several simple shell scripts (see Appendix). We timed the scripts by first clearing the page cache, then running the traditional version of the script, then running the conditional version of the script.

3. Note the use of INTEL assembly syntax, where the source operand comes after the destination operand.

The tested tasks were:

- * ‘echo’ which makes two static checks and echos a string depending on the result;
- * ‘copy’ which copies the smaller of two files to a destination;
- * and ‘compile’ which compiles an output file depending on the timestamp of a source file.

Results are given in Table I. In all cases the predicated execution version of the task does better. Indeed, for the compile task, the overall execution time is reduced to 1894299ns -- that’s 139426014ns faster than simply running the compiler!

4 Pushing performance

While a 2-100x cyclefold improvement is nothing to shake a luggable microcomputer’s vacuum fluorescent display at, these results fall short of what we could hope for. One possible explanation for the lukemoist performance is that the condition itself is stored in a high-level way (see Figure B) using environment variables. Using high-level parts of the computer is a well-known cause of cycle overslows.

The fastest place to store the condition is in the CPU itself, using electrons. The CPU can only be accessed

task	copy	echo	compile
ours	457516888ns	14104407ns	1894299ns
old	5753853493ns	29336387ns	182916245ns

Table I: Benchmark results. Our approach is dramatically faster in all cases.

through the Operating Kernel. As a proof of concept, the authors created a Kernel module⁴ that directly accesses the CPU's FLAGS register. It presents the flags as files in the /proc filesystem where they can be accessed by any process:

```
$ ls -al /proc/flags
-rw-rw-rw- 1 root root 0 af
-rw-rw-rw- 1 root root 0 cf
-rw-rw-rw- 1 root root 0 df
-rw-rw-rw- 1 root root 0 if
-rw-rw-rw- 1 root root 0 iopl0
-rw-rw-rw- 1 root root 0 iopl1
-rw-rw-rw- 1 root root 0 nt
-rw-rw-rw- 1 root root 0 of
-rw-rw-rw- 1 root root 0 pf
-rw-rw-rw- 1 root root 0 sf
-rw-rw-rw- 1 root root 0 tf
-rw-rw-rw- 1 root root 0 zf
```

Each file contains -- at the moment that it is read -- either are '1' or '0' if the corresponding bit is set in the FLAGS register. Writing a '1' or '0' to a file will modify the corresponding bit. The 'c' utility described in Section 2-2 has experimental support for storing the condition result in the cf flag (formally 'carry flag' but the mnemonic can also be used for 'condition flag') via this kernel extension.

Alas, with great power comes great instability. There is some risk that the FLAGS register⁵ is modified by other applications running in time-share with the 'main' shell script. In this case, the FLAGS register may not correctly reflect

4. It can be downloaded via hypertext at sf.net/p/tom7misc/svn/HEAD/tree/trunk/csh/
5. As an additional technical matter, this approach does not work for multiprocessor systems, where there is one FLAGS register *per CPU*. Fortunately, such systems are a mere theoretical curiosity.

the indicated status, and conditional operations may occur or not occur contrary to the shell program's coding. On the other hand, some uses of /proc/flags are very robust. For example, setting /proc/flags/tf, the trap flag, reliably terminates the current process with a fatal error.

We installed this kernel module on several shared workservers that we administer. Preliminary user reports include indications that the behavior is 'very unstable' or 'does not work at all.' Clearly, a wider-scale test deployment is needed.

5 Future Work

Given that predicated execution leads to a CISC-ridiculous improvement in the speed of shell scripts, it is natural to ask what other CISC-onesquential results can be obtained by bringing other micro-architectural features to high-level languages.

Branch delay slots -- instructions after a branch that are always executed -- can already be trivially supported in shell by writing the delayed commands as a background task in front of the branch in question, then foregrounding them afterward, as per:

```
delay-command &
if [ -x "something" ]
then
    fg
    #...
else
    fg
    #...
fi
```

Notice that this is actually much more flexible than current (MIPS) microprocessor implementations, since multiple commands may be queued in the delay slot

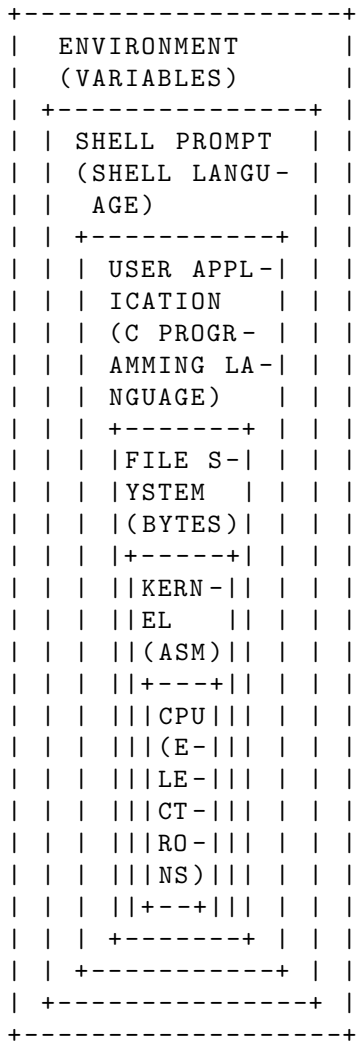

Figure B: The ‘levels’ of a computer-system, from ‘high’ (outer boxes) to ‘low’ (inner boxes). As we descend to lower levels of the computer, the programming tools used (in parentheses) become more difficult, but more powerful, and more fast. Only master wizards are permitted at the lowest levels, such as ‘CPU’.

position and overlapped with the test execution.

A similar approach works to enable speculative execution, wherein code in a conditional is executed before the condition is checked:

```

true-command &
false-command &
if [ -x "something" ]

```

```

then
    kill %%
    fg %-
else
    kill %-
    fg %%
fi

```

Mind you, if either true-command or false-command have any side-effects before the test completes, this approach may lead to undesirable output; but a fast enough CPU will certainly turn this ‘race condition’ into a ‘victory condition’. As a compromise, on slower CPUs, each branch of the if statement could be run in a separate chrooted union-mount, with a snapshot of the result written back after the test has resolved.

Such a technique may be vulnerable to the Spectre vulnerability, leaking information to other processes on the time-share via side-channels like the cache. Thus it is recommended to flush the cache before and after using this technique:

```

sync
echo 3 > /proc/sys/vm/drop_caches
swapon -a
true-command &
false-command &
if [ -x "something" ]
then
    kill %%
    fg %-
else
    kill %-
    fg %%
fi
swapon -a
echo 3 > /proc/sys/vm/drop_caches
sync

```

6 Conclusions

We have demonstrated that shell scripts can benefit from conditional execution.

Q	E
E	D

Appendix: Test Code

This appendix contains source listings for the the shell programs used in the benchmarking process described above. The utilities 'cecho', 'ccp', and 'ccc' are all links to the 'c' program described in the main body of the paper. Notice how the predicated execution versions are also generally shorter than their traditional counterparts.

```
# Echo; traditional | # Echo; predicated execution
if [ "A" = "A" ] | [ "A" = "A" ]
then | cecho "Hello"
  /bin/echo "Hello" | [ "A" = "B" ]
fi | cecho "World"
if [ "A" = "B" ] |
then |
  /bin/echo "World" |
fi |

# Copy; traditional | # Copy; predicated execution
sizeA='stat -c %s fileA' | sizeA='stat -c %s fileA'
sizeB='stat -c %s fileB' | sizeB='stat -c %s fileB'
if [ $sizeA -le $sizeB ] | [ $sizeA -le $sizeB ]
then | cecho "fileA is smaller"
  echo "fileA is smaller" | ccp fileA fileS
  cp fileA fileS | [ $sizeA -gt $sizeB ]
else | cecho "fileB is smaller"
  echo "fileB is smaller" | ccp fileB fileS
  cp fileB fileS |
fi |

# Compile; traditional | # Compile; predicated execution
if [ "prog.cpp" -nt "prog" ] | [ "prog.cpp" -nt "prog" ]
then | cecho "Compiling program..."
  cecho "Compiling program..." | ccc prog.cpp -lstdc++ -o prog
  cc prog.cpp -lstdc++ -o prog | ./prog
fi |
./prog |
```

NaN-Gate Synthesis and Hardware Deceleration

Cassie Jones
Witch of Light
list+sigbovik@witchoflight.com

1 April 2020

Abstract

In recent years there has been interest in the field of “hardware decelerators,” which serve primarily to make computation more interesting rather than more efficient. This builds off the work of “NaN-Gates and Flip-FLOPS” [9] to provide a hardware synthesis implementation of real-number computational logic using the Yosys Open Synthesis Suite [1] framework, and evaluates the impacts of different floating point formats.

ACH Reference Format:

Cassie Jones. 2020. NaN-Gate Synthesis and Hardware Deceleration. In *Proceedings of SIGBOVIK 2020*, Pittsburgh, PA, USA, April 1, 2020. (SIGBOVIK ’20, ACH).

Introduction

Hardware decelerators work on the principle of “stop and smell the roses.” There are some qualities that are more important than sheer efficiency, and often these improvements can often only be realized by taking the computer and slowing it down to a more leisurely pace. The largest advancements in the field happen in the emulation space, since it’s the most widely accessible. It may be most familiar in the form of video-game computers, building computers out of redstone in Minecraft, Factorio combinators, or the like [7] [6].

“But of course speed is not what we’re after here. We’re after just, beautiful computation going on inside the heart of this machine.” — Tom7 [10]

The SIGBOVIK 2019 paper “NaN-Gates and Flip-FLOPS” decelerates computers in the name of elegance: it throws away the assumption of binary computers and builds ones based on real numbers, specifically IEEE-754 floating point numbers. It aims towards “reboot computing using the beautiful foundation of real numbers,” but it still leaves us with room for improvement in a few areas. It leaves the logic gates in the domain of emulation, which limits the types of hardware that are easy to build, and it limits the elegance that can be achieved. Since it uses an existing CPU as the floating point processor, it’s still left with a computer that’s based on binary emulating the real number logic.

Here, we attempt to remove this limitation by bringing NaN-gate computation to the domain of native hardware, via a custom Yosys synthesis pass.

1 NaN-Gate Synthesis

The Yosys Open SYnthesis Suite [1] is a free and open source architecture-neutral logic synthesis framework. It can synthesize Verilog into a variety of backend formats using a flexible and pluggable architecture of passes. The Yosys manual has a chapter on how to write extensions [2, Ch. 6], which can be consulted for documentation and examples on how Yosys passes are built. We provide a Yosys extension which synthesizes a circuit down to a network of small floating point units implementing the NaN-gate function. This can be further synthesized to a final target, like a specific FPGA architecture.

1.1 Yosys Synthesis

We will demonstrate all synthesis with the following toggle module, since it’s small enough for all stages of synthesis results to be understandable and fit neatly on the page.

```
module toggle(input clk, input en, output out);  
    always @(posedge clk) begin  
        if (en) out <= ~out;  
    end  
endmodule
```

Yosys will take a Verilog module like this and flatten the procedural blocks into circuits with memory elements. Running synthesis gives us a circuit with a flip-flop, a toggle, and a multiplexer that’s driven by the enable line.

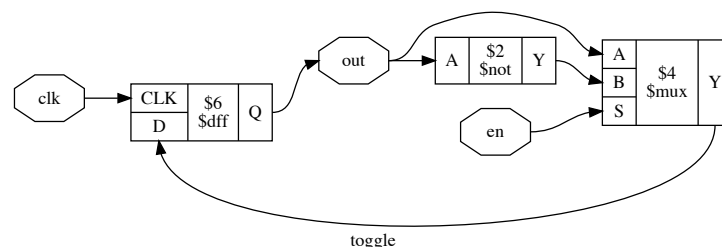

Figure 1: The synthesized toggle circuit.

We can also ask yosys to synthesize this to exclusively NAND and NOT gates with a small synthesis script.

```
read_verilog toggle.v  
synth  
abc -g NAND
```

This particular design synthesizes to 1 D flip-flop, 3 NAND gates, and 2 NOT gates.

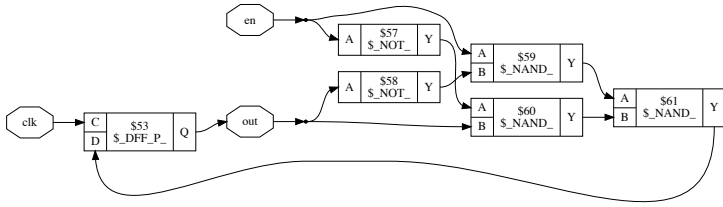

Figure 2: The circuit synthesized down to only NAND, NOT, and memory elements.

1.2 The Yosys synth_nan Pass

Our `synth_nan` pass is implemented as a Yosys extension. For convenience, we'll describe the behavior in terms of the 3-bit float synthesis. It converts a module to NaN-gate logic. It summarizes itself as running:

```
synth
abc -g NAND
nand_to_nan
share_nan
dff_nan
simplify_nan
clean
techmap_nan
```

The first two steps there are standard synthesis. The `synth` pass will convert a module into coarsely optimized circuits, and `abc -g NAND` will remap the entire thing into optimized NAND logic.

One complexity we have to deal with is external interfaces. Despite the wonderful realms of pure real-number computation we want to interact with, when interacting with fixed hardware component interfaces, we have to convert between floats and bits. In order to handle this, the NaN gate tech library has modules like `fp3_to_bit` and `bit_to_fp3` which perform this boundary conversion. In order to deal with the chaotic diversity of real circuits, for robustness, the `nand_to_nan` pass converts each NAND gate to a `bit_to_fp3` -> NaN -> `fp3_to_bit` chain. Don't worry, these conversions will later be removed everywhere they don't turn out to be necessary.

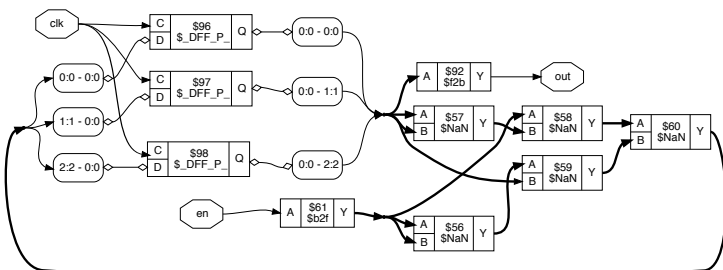

Figure 3: The toggle circuits synthesized to NaN gates. Note that the external logic ports have floating point conversion modules, but the clock line doesn't.

The `share_nan` pass reduces the number of conversions by sharing ones that have the same inputs. Then, the `dff_nan` pass can expand the flip-flops in the circuit into a set of enough flip-flops to store the floating point values.

The `simplify_nan` pass converts any instance of `fp3_to_bit` -> `bit_to_fp3` to just a wire that passes the floats straight through.

We do `clean` to remove dead wires and useless buffers, and then finally the `techmap_nan` pass replaces the opaque NaN-gate modules with actual modules so that further synthesis can properly make them realizable on real hardware.

1.3 Module Ports

If you want your circuit to support external floating-point based interfaces, you can use the floating point conversion modules yourself.

```
module toggle(
    input clk, input [2:0] en, output [2:0] out);

    wire en_b;
    reg out_b;
    fp3_to_bit en_cvt(en, en_b);
    bit_to_fp3 out_cvt(out_b, out);
    always @(posedge clk) begin
        if (en_b) out_b = ~out_b;
    end
endmodule
```

The NaN synthesis will end up erasing the floating point conversions on either side of the interface since they connect to floating point units. Future work could include automatically expanding ports using something like a `(* nan_port *)` attribute.

2 Floating Point Formats

While tom7's work asserts that a **binary4** floating point format is "clearly allowed by the IEEE-754 standard," this doesn't seem to hold up under a close examination. Brought to my attention by Steve Canon [8], there are two cases where these floating point formats fall down. First, and most importantly in the case of **binary4**, you need to encode both quiet- and signaling-NaN. Section 3.3 of IEEE-754 says [5]:

"Within each format, the following floating-point data shall be represented: [...] Two NaNs, qNaN (quiet) and sNaN (signaling)."

While **binary4** does have two separate NaN values (a positive and a negative), they are distinguished only by their sign bit, which isn't allowed to distinguish the two types of NaNs, as we can see in 6.2.1:

"When encoded, all NaNs have a sign bit and a pattern of bits necessary to identify the encoding as a NaN and which determines its kind (sNaN vs. qNaN)."

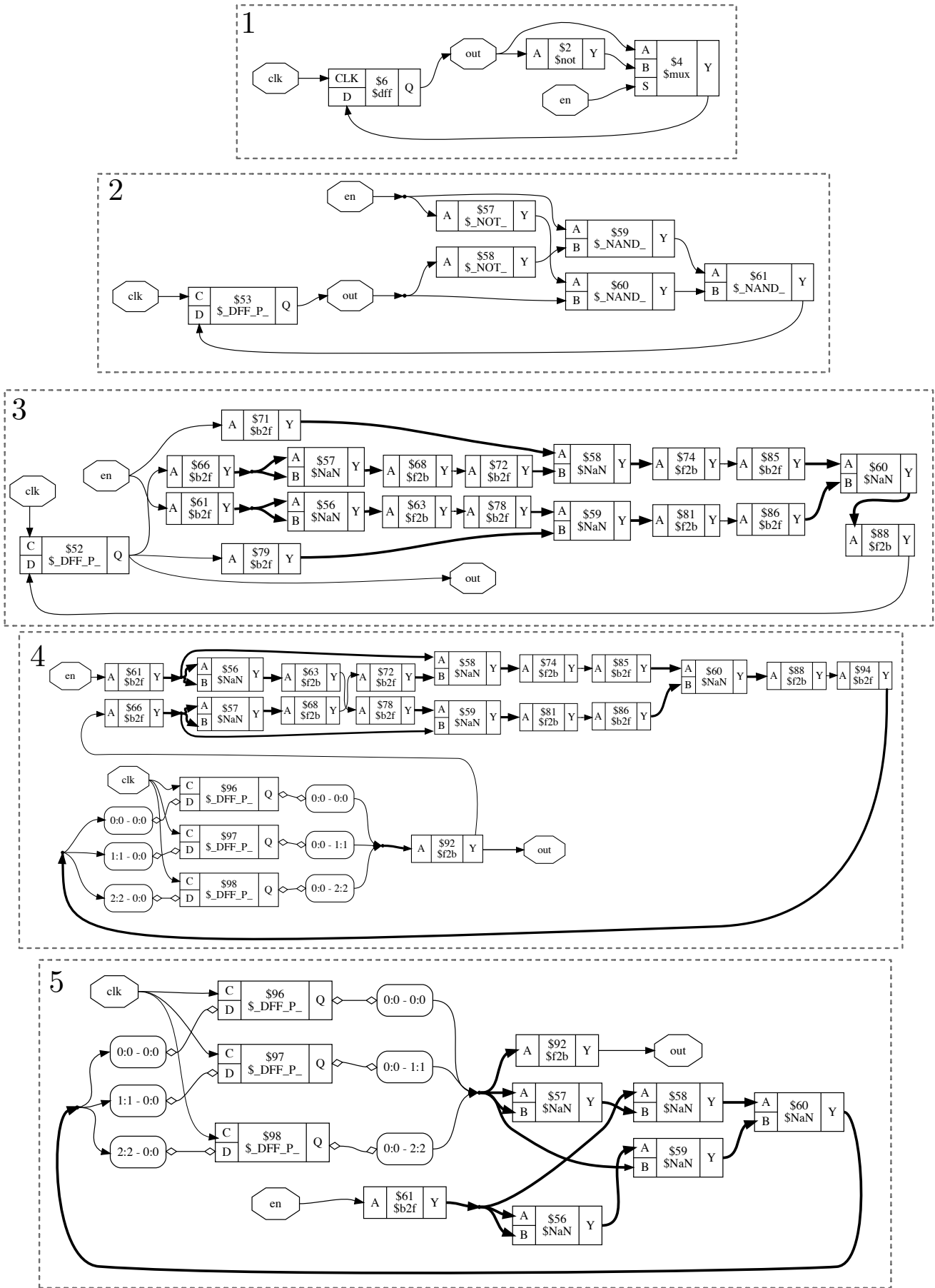

Figure 4: The full NaN-gate synthesis process for the toggle module. In step 1 we have the logical circuit after coarse synthesis. In step 2 it's synthesized to NAND and NOT gates. Step 3 converts the gates to NaN gates and adds conversion chains. Step 4 expands the flip-flops to store floats. Step 5 collapses redundant conversion chains to give the final NaN-synthesized module.

This means that we need at least two bits in the mantissa in order to represent the infinities (stored as a 0 mantissa with the maximum exponent) and the NaN values (stored with two distinct non-zero mantissas).

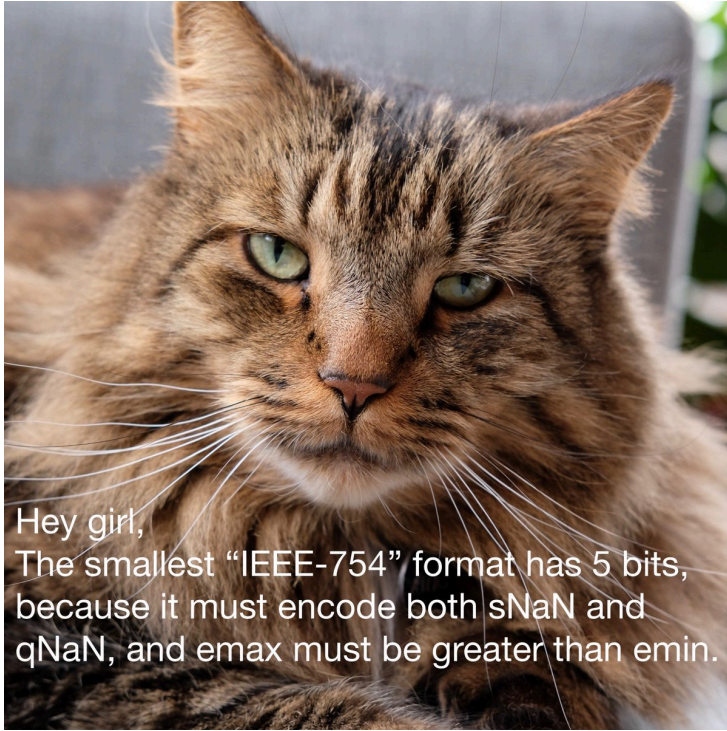

Figure 5: From Steve Canon’s tweet [8]. As the cat says, since IEEE-754 requires $emax$ to be greater than $emin$, there must be two exponent bits, and since the mantissa must be used to distinguish sNaN, qNaN, and infinity, so it also needs at least two bits, leading to a minimum of 5-bit floats.

The **binary3** format is further disrupted in section 3.3, which rules-out the idea of having an empty range of $emin$ and $emax$, since they’re used in an inequality and $emin \leq emax$, and is elsewhere forced to be strictly less by other constraints:

“ q is any integer $emin \leq q + p - 1 \leq emax$ ” 3.3

Still, the **binary3** format is very useful for efficient implementation of NaN gates, and is worth including in synthesis for people who aren’t bothered by standards compliance. For completeness, the `synth_nan` implementation supports synthesis to **binary3**, **binary4**, and the definitely-IEEE-754-compliant **binary5** format NaN-gates. Furthermore, the architecture would support easy extensions to larger, more conventional floating point formats like **binary8**, or even larger, by simply loading your own library of modules named `nan_fpN`, `bit_to_fpN`, and `fpN_to_bit`, for any value of N you want to synthesize with.

2.1 The binary5 Representation

Here we document the representation in the **binary5** format, the smallest legal IEEE-754 compliant binary floating-point format. It has a sign bit, a two bit exponent, and a two bit mantissa. We include a table of all of the positive values here:

s	E	T	value
0	00	00	+0.0
0	00	01	+0.25
0	00	10	+0.5
0	00	11	+0.75
0	01	00	+1.0
0	01	01	+1.25
0	01	10	+1.5
0	01	11	+1.75
0	10	00	+2.0
0	10	01	+2.5
0	10	10	+3.0
0	10	11	+3.5
0	11	00	+inf
0	11	01	sNaN
0	11	10	qNaN
0	11	11	qNaN

The positive values representable in the **binary5** format. Note that infinity, sNaN, and qNaN are all distinguished by the mantissa value when the exponent is all ones, so this is the smallest possible floating point format. The negative values for each are the same bit patterns but with a 1 in the sign bit.

2.2 Evaluation

We compare the size (in both logic and memory elements) and clock speed of modules synthesized with the different floating points. For the benchmark, we use a pipelined 32-bit multiplier, and the PicoRV32 processor [3] synthesized for the ECP5 architecture, and placed and routed using nextpnr [4]. The numbers given for clock frequency are the best result of 10 runs of placement and routing.

The “NAND” variant are synthesized to NAND gates before architecture-specific optimization, in order to obscure some of the higher-level modules that are present in the original design and prevent optimizations that won’t be available to the NaN-gate synthesis. This gives a clearer baseline for comparison with the NaN gates, and so this is used as the basis for relative numbers. Times marked **DNP** are those that did not successfully place and route for timing analysis, so no frequency can be reported.

Design	Variant	Cells	Cell%	DFFs	DFF%	(MHz)
PicoRV	Direct	1884	57%	888	48%	103.55
	NAND	3328	100%	1848	100%	47.30
	fp3	43739	1314%	5544	299%	DNP
	fp4	32853	987%	7392	400%	DNP
	fp5	65511	1968%	9240	500%	DNP
Mult32	Direct	2879	104%	628	100%	143.04
	NAND	2773	100%	628	100%	154.37
	fp3	25349	880%	1884	300%	25.26
	fp4	19026	661%	2520	400%	21.88
	fp5	38001	1320%	3140	500%	21.18

It’s interesting that fp4 is the smallest of the floating point variants in logic, rather than fp3. It seems likely that this is because the ECP5 architecture is based on “LUT4” cells—4-input lookup tables—which means individual NaN-gates might happen to synthesize more efficiently with 4-bit inputs.

2.3 Flattening

For this benchmark, we synthesize designs without flattening post NaN-gate synthesis, because the optimizer is too effective and eliminates most of the floating point logic. When they are flattened, the optimizer can consider the logic involved in the individual NaN gates and re-combine them and erase constant-value flip-flops. Designs that are flattened before optimizing have no flip-flop overhead, and have on the order of 5% overhead in logic elements vs the reference NAND-gate versions.

While synthesizing with post-NaN flattening substantially undermines the floating point logic and mostly demonstrates the impressive quality of Yosys's optimizations, it suggests as an option a sort of "homeopathic floating-point logic." For users that require efficiency but still want *some* of the elegance benefits, they can flatten it and optimize it away, keeping some peace-of-mind in knowing that their final circuit is derived from an elegant real-number system, regardless of how it currently behaves.

3 Future Work

Floating point synthesis still has many avenues for improvement and future work.

The current synthesis approach used by `synth_nan` remains fragile in the face of flattening and pass-ordering. It should be possible to make it harder to accidentally flatten the designs away into nothing, but they still do need to be eventually flattened since the `nextpnr` place-and-route flow is still not fully reliable in the presence of un-flattened designs. Currently the `synth_nan` pass must be run before any device-specific passes, which can be fine but it prevents the utilization of resources such as distributed RAMs.

Float synthesis tools should make it easier to define module ports that should be expanded to accommodate floating-point based signals, so that designs can operate fully in the glorious domain of the real numbers, without having to flatten all designs.

More work could be done into ensuring that the individual gates are properly optimized for different architectures, since it seems unreasonable for fp4 to remain more efficient than fp3. The system could also benefit from implementing a larger set of primitive gates, to avoid the blowup of using NAND gates to emulate everything, since they should be implementable in similar amounts of elementary logic.

With `binary5` and larger, there looks like there could be potential in attempting to explore designs that work *purely* on NaN values, exploring the flexibility in the handling of signaling and quiet NaN values.

The NaN-gate synthesis plugin for Yosys can be found at <https://git.witchoflight.com/nan-gate>. This paper and the examples materials in it can be found at <https://git.witchoflight.com/sigbovik-nan-2020>.

References

- [1] Claire Wolf. The Yosys Open SYnthesis Suite. Online. <http://www.clifford.at/yosys/>
- [2] Claire Wolf. The Yosys Manual. Online. http://www.clifford.at/yosys/files/yosys_manual.pdf
- [3] Claire Wolf. PicoRV32 - A Size Optimized RISC-V CPU. Online. <https://github.com/cliffordwolf/picorv32>
- [4] Claire Wolf, David Shah, Dan Gisselquist, Serge Bazanski, Miodrag Milanovic, and Eddie Hung. NextPNR Portable FPGA Place and Route Tool. 2018. Online. <https://github.com/YosysHQ/nextpnr>
- [5] IEEE Standard for Floating-Point Arithmetic. 2019. In *IEEE Std 754-2019 (Revision of IEEE 754-2008)*. Pages 1–84. DOI 10.1109/IEEESTD.2019.8766229.
- [6] justarandomgeek. 2017. justarandomgeek's Combinator Computer Mk5. Online. <https://github.com/justarandomgeek/factorio-computer>
- [7] legomasta99. 2018. Minecraft Computer Engineering - Redstone Computers. Online. https://www.youtube.com/watch?v=aj6IUuwLyOE&list=PLwdt_GQ3o0Xe6pUS1vdzy0ZqXrApB2MNU
- [8] Stephen Canon. 2017. A Tweet About IEEE-754. Tweet by @stephentyrone on April 1, 2017. <https://twitter.com/stephentyrone/status/848172687268687873>
- [9] Tom Murphy VII. 2019. NaN Gates and Flip FLOPS. In *Proceedings of SIGBOVIK 2019*, Pittsburgh, PA, USA, April 1, 2019. (SIGBOVIK '19, ACH). Pages 98–102.
- [10] Tom Murphy VII. 2019. NaN Gates and Flip FLOPS. Online. <http://tom7.org/nand/>

hbc: A CELEBRATION OF UNDEFINED BEHAVIOR

Andrew Benson*
Department of Computer Science
Stanford University
Stanford, CA 94305
adbenson@stanford.edu

April 1, 2020

ABSTRACT

We present *hbc*, a next-generation compiler with half the performance of `clang` but twice the fun. We prove by way of demonstration that undefined behavior in a spec-abiding C compiler can do more than just segfault.

Keywords Compilers · Undefined Behavior · Bash Misuse · Computer Music · Principles of Imperative Computation

1 Introduction

The C programming language has gone through several iterations (C89, C99, etc), but each edition leaves some behavior under-specified. For example, while the C standards specifies that a plain `char` must be 1 byte in size, it does not specify its sign. Each compiler that implements C may choose whether a plain `char` is signed or unsigned. Because this behavior is not dictated by the standard but implementations must define it in a consistent fashion, this behavior is called **implementation-defined**.

Some other behaviors are even looser. Not only do the C standards not prescribe a particular behavior, but implementers are not required to make the behavior consistent. The most infamous example is probably dereferencing a NULL pointer (or any other invalid pointer). The C standards do not say what should happen, and while code produced by most compilers will probably segfault, it does not have to, nor does it have to do the same thing on two separate occasions. It is perfectly valid for it to delete your tax statements, or even to start playing a melody through the speakers! (That's called foreshadowing.) Because no definitions are specified by the C standards or the compilers, this is called **undefined behavior**.

2 Motivation

Computer science students are generally introduced to these concepts in their first systems-level course in C. In the author's experience, students are generally confused by these concepts since mainstream compilers are rather consistent in either hanging or segfaulting when encountering these behaviors. Although the concepts are distinct, students tend to equate "segfaults" with "undefined behavior" and direct the former's rightfully deserved ire onto Poor, Mistreated Undefined Behavior. Not only is there a misunderstanding of what these foundational concepts mean, but students develop a fearful anxiety and distrust of Undefined Behavior. It's unjust, and it's time that someone stood up for Undefined Behavior. The mainstream compilers like `gcc` and `clang` are too self-absorbed in exploiting Undefined Behavior for frivolous goals such as "performance" and "implementation-simplicity", so the only way is to build a new compiler that respects Undefined Behavior for what it is and what its potential can be.

The author also recalls sitting in a 15-122 lecture freshman fall where the professor suggested that a C program could play 'Happy Birthday' during undefined behavior. That may also have had some influence on this project.

*Also a software engineer at Google, which was not involved in this research. All code is Copyright 2020 Google LLC and when provided is on the Apache 2.0 License.

3 Design

And by “new compiler”, what the author really means is “wrap an existing compiler (one of those he previously mocked) and call it a new one”. This is an application of the Software Engineering Principle “ain’t nobody got no time fo dat” [building a compiler from scratch]. The author procrastinated and only had a few hours to build it, okay?

The main goal of this new compiler, `hbc` (the Happy Birthday Compiler),² is to compile C programs correctly but for some subset of undefined behavior, play the “Happy Birthday” song. The subset of undefined behavior was chosen to be specifically when a NULL pointer is dereferenced.³

It is well-known that the general problem of reasoning about the runtime value of anything in a program reduces to the Halting problem. Thus it’s clear that checking for NULL pointers cannot be done statically, and null-checks must be inserted into the code. A LLVM compiler pass seems ideal for this, although ironically the pass will clutter the code instead of optimize it. This would be done at the IR level, but we can simply consider LLVM load and store instructions. The injected code can examine the dereferenced value and if NULL, can call our custom code that plays Happy Birthday.

3.1 Getting the Music File

The author doesn’t fancy getting sued, so he didn’t want to rip a track of Happy Birthday off the Internet. Since this compiler is certainly going mainstream, the costs of a commercial license would also be out of the question. Thus the author painstakingly dragged and dropped sine waves in Audacity and recreated a tasteless rendition of the tune by ear. He hopes that’s enough to avoid lawsuits.

3.2 Playing the Music File

It turns out there’s no `playMyOggVorbisMusicFile()` syscall in the Linux kernel. Who knew? The author eventually decided to link against `libcanberra`, a Linux library that is apparently capable of playing audio files.

Using this, we create a C function that takes in a pointer, checks whether it’s NULL, and if so, plays Happy Birthday. Since all of this has to end up in the compiler’s outputted executable, we embed the entire audio file into the C source code as a base64-encoded string. Was this a good idea? The jury’s still out.

3.3 The LLVM Compiler Pass

The compiler pass doesn’t seem hard - just throw null checks onto every load or store instruction, and pretend that it’s not going to destroy performance (it is). We could definitely make this significantly better by doing a dataflow analysis and removing null checks for statically provably non-null pointers (e.g. pointers that have previously been checked), but that would have taken effort.

But it was still difficult for the author because he’s bad at C++, especially LLVM’s variant.

3.4 Outputting an Executable

Because the author enjoys pain, he decided that the compiler executable would just be a bash script that drives each portion of the compilation process. Yep. At a high level, the script compiles the input C files to LLVM bitcode, links the bitcode into a big bitcode file (along with the bitcode for the function that plays the music file), runs the LLVM pass, assembles the bitcode into assembly, and links it alongside its dependencies.

3.5 Shell Scripting Inception

As briefly mentioned, everything needs to go into a single compiler executable, including the bitcode for the music player function and the shared object implementing the compiler pass. The author brilliantly decided to inline all of that into the shell script, again using base64 encoding. And because he didn’t want to re-inline everything very carefully each time any of the inlined dependencies changed, he wrote a bash script that generates the bash script executable that compiles C programs into Happy Birthday-playing executables. If stacking more layers is a legitimate solution in Machine Learning, why not here?

²The code for `hbc` can be found at <https://www.github.com/anbenson/hbc>.

³It was chosen because the author is lazy wanted to pick a behavior many programmers have experienced before.

```
:) andrew@heracross ~/sigbovik/2020/src
08:29 AM $ ./gen_hbc.bash

:) andrew@heracross ~/sigbovik/2020/src
08:29 AM $ ./hbc ptr.c

:) andrew@heracross ~/sigbovik/2020/src
08:29 AM $ ./a.out
About to segfault!
```

Figure 1: I promise it's a lot more fun when you can hear it playing Happy Birthday.

3.6 Testing

you always pass all the tests you don't write

4 Properties

I claim that `hbc` is a standards-abiding C compiler.

Proof. By reduction.

We assume that `clang` is a standards-abiding C compiler. Let X be an arbitrary C program from the space of valid C programs. Suppose X does not dereference a NULL pointer on any input. Then X 's behavior is identical on `hbc` and `clang`. Suppose there exists an input for which X dereferences a NULL pointer. Consider the first instance in time at which X dereferences a NULL pointer. This is undefined behavior, so anything after this point in time should not be considered. But in everything before this instance, X has the same behavior on `hbc` and `clang`. Thus `hbc` has identical behavior to `clang` on non-undefined behavior and thus it is a standards-abiding C compiler.

5 Results

The author tried a test case or two. They seem to work. So it probably works. But you should try it, it's fun to see your program suddenly burst into song when it dereferences a NULL pointer.

The author did not try any benchmarks, but they're probably disappointing.

6 Applications

I dunno. It's fun? It serves as a basis for a SIGBOVIK paper? It's a fun aside in a 15-122 lecture?

7 Future Work

Nope, we're done here.

8 Acknowledgements

The author would like to thank his 15-122 professors, Tom Cortina and Rob Simmons, who were part of the inspiration for this project and helped cultivate an interest in C and compilers.



CONFIDENTIAL COMMITTEE MATERIALS

SIGBOVIK'20 3-Blind Paper Review

Paper 34: hbc: A celebration of undefined behavior

Reviewer: <noreply-utos@google.com>

Rating: <sigbovik@gmail.com>

Confidence: Learn more about our updated Terms of Service

We're improving our Terms of Service and making them easier for you to understand. The changes will take effect on March 31, 2020, and they won't impact the way you use Google services.

For more details, we've provided a summary of the key changes and Frequently Asked Questions. At a glance, here's what this update means for you:

- **Improved readability:** While our Terms remain a legal document, we've done our best to make them easier to understand, including by adding links to useful information and providing definitions.
- **Better communication:** We've clearly explained when we'll make changes to our services (like adding or removing a feature) and when we'll restrict or end a user's access. And we'll do more to notify you when a change negatively impacts your experience on our services.
- **Adding Google Chrome, Google Chrome OS and Google Drive to the Terms:** Our improved Terms now cover Google Chrome, Google Chrome OS, and Google Drive, which also have service-specific terms and policies to help you understand what's unique to those services.
- **No changes to our Privacy Policy:** We're not making any changes to the Google Privacy Policy and we haven't made any changes to the way we treat your information. As a reminder, you can always visit your Google Account to review your privacy settings and manage how your data is used.

If you're the guardian of a child under the age required to manage their own Google Account and you use Family Link to manage their use of Google services, please take some time to discuss these changes with them.

And of course, if you don't agree to our new Terms and what we can expect from each other as you use our services, you can find more information about your options in our Frequently Asked Questions.

Thank you for using Google's services.

Your Google team

Theory

14 A polynomial-time SAT algorithm

Anonymous Author(s)

Keywords: theoretical computer science, complexity theory, p versus np

15 Empire Machines and beyond

Darío de la Fuente García, Félix Áxel Gimeno Gil, Juan Carlos Morales Vega

Keywords: finite-state machines, models of computation, Empire Machines, doing research like this is awesome, Civilization XXIV (when it comes out)

16 Artificial General Relativity

Pablo Samuel Castro

Keywords: physics, artificial, general relativity, quantum physics, universe-changing, new science, field equations, black holes

17 Lower gauge theory: Dead duck or phoenix?

Oscar I. Hernandez

Keywords: mathematical physics, category theory, ToE, quantum gravity, mathematical economics, marginal analysis

18 Making explicit a constant appearing in an impossible equation of Carl and Moroz

Matthew Weidner

Keywords: computational mathematics, Hilbert's tenth problem, Diophantine sets

A polynomial-time SAT algorithm

Anonymous Author(s)

Abstract

In this paper, we present an algorithm for solving the boolean satisfiability problem in time $O(n^2)$, thus resolving the P versus NP problem.

1 Introduction

In the interest of preserving the triple-blind nature of the review system of this conference, we omit the text of this paper.

EMPIRE MACHINES AND BEYOND

Darío de la Fuente García

Félix Áxel Gimeno Gil

Juan Carlos Morales Vega

March 10, 2020

ABSTRACT

This paper addresses one key weakness in traditional State Machines: fixed behavior and number of states. We introduce Empire Machines, which solve that problems and pursue an equal and completely just world. They can also be used to model any Civilization game. Probably.

Keywords Finite-State Machines · models of computation · Empire Machines · doing research like this is awesome · Civilization XXIV (when it comes out)

1 Introduction

State Machines have a long history: the first instance of them, Markov chains, was described and formalized in 1906 [1]. However, State Machines have one key limitation: the behavior of states, and the number of states, is fixed at compilation time¹. This is obviously not realistic, as the conditions of the system being simulated may change. Moreover, states in real life do not behave like this: they conquer each other, have revolutions and occasionally self-destruct, which is kinda nice. The states of classical State Machines are too peaceful. The states with low probability are too conformist and cannot get out of their misery while the states with high probability will always hold the power and laugh at the weak. We feel in the moral obligation of ending this oppression that has been active for more than one hundred years. To achieve that, we feel proud to introduce the glorious concept of Empire Machines, a novel architecture that can end all of these problems and provide true justice.

2 Motivation

Look at the following map of the Roman Empire in 1356. Beautiful and chaotic, right?

¹Note that interpreted programming languages are the work of the devil. We will ignore their existence in this paper.

3 Related work

For more background on the useless Finite-State Machines please see [2].

See (partially unrelated) [3].

See the author's past work (obviously unrelated) [4].

Also important to understand motivation: <https://civilization.com/en-GB/>

4 Idea sketch

For inspiration (and also how to get the best intuition about Empire Machines) watch <https://www.filmaffinity.com/es/film485194.html> while drunk. The authors do not encourage nor discourage drunkenness.

Now that you are questioning why that film even exists, you can continue reading. Since your mind should be by now too occupied with that thought, you should not be able to question why our paper even exists. A clear win-win situation, right?

5 Definitions and formalism

If we want to model a Empire Machine, we first need to distinguish two different behaviors: the interactions that happen within a State Machine, and the interactions that happen between different State Machines within the bigger and more glorious Empire Machine.

5.1 Intra-State Machine interactions

Our novel State Machine model can still be modelled in the same way as a classical one. Each state has a certain power (AKA probability for noobs) and the sum of all of them needs to be equal to 1 (on further work we will expand the model to the case where the sum of probabilities equals π (or e (or 3, all of them are the same after all))). The power of the states evolves through time using the money transactions (AKA transition probabilities) between different states. The power after a time step can be computed in the same way as in a classical state machine, by multiplying the Money Transaction Matrix (or MTM, to make it shorter) times the current power.

So far so good. Now is where things start getting interesting.

5.1.1 Revolution

A revolution can happen if the following condition is fulfilled:

$$P_i^r < k \sum_{j \neq i}^M \frac{P_j^r}{M-1} \quad (1)$$

Where k is a State Machine-dependent non-negative, probably-positive, maybe-imaginary constant. For simplicity and since we are very lazy, we will only consider the case where P_i is positive.

When a revolt happens, a state is killed. Since states die when they are killed [5], it disappears without a trace and its power is distributed evenly between the rest of states. The MTM is recomputed by deleting the correspondent row and column and distributing the transaction routes evenly between the other states.

5.1.2 Division

A division can happen when there are too few commercial routes between any two subsets of states, S_1 and S_2 , that cover the space of the State Machine and such that the number of states of the smallest of the two is at least one third the number of states of the biggest one. In this case the State Machine breaks apart into two different State Machines, which become part of the Empire Machine. The total power of each State Machine is normalized to add up to one again. The MTM breaks into two new MTMs and the money transactions are normalized within each column to maintain the correct behavior of the State Machines.

5.1.3 Birth

A state can appear out of nothing whenever it feels like it. Seriously. When this happens, the newborn state starts with 0 power. The MTM is modified by adding a row and a column. The column is initialized at random (with the condition that it adds up to 1) while the row is initialized by stealing some commercial routes from other states. The details of the second process are far too complex and are beyond the scope of this serious paper.

5.1.4 Pandemic

The State Machine enters a chaos era. Everything is randomized. The powers are distributed between the states and the MTM becomes a completely new matrix. Some states can also die, but the other states are usually too busy trying to survive to even notice that.

5.2 Inter-State Machine interactions

A Empire Machine can be modeled in the same way as a State Machine, with each State Machine possessing a certain power and some money transactions between State Machines. Hence, State Machines within a Empire Machine can interact between them using the same processes as the states within a State Machine. But they are more awesome. Additionally, there are a few operations that are specific to Empire Machines, as we describe below.

5.2.1 Fusion

If two State Machines have a strong commercial relation, they can fuse together with a certain probability that depends on the two States Machines. The condition for the fusion of the State Machines i, j reads:

$$\begin{cases} P_i^f P_j^f & \text{if } \text{MTM}_{ij}^1 \cdot \text{MTM}_{ji}^2 \geq 0.5 \\ 0 & \text{if } \text{MTM}_{ij}^1 \cdot \text{MTM}_{ji}^2 < 0.5 \end{cases} \quad (2)$$

The inner powers of the combined State Machine and the inner MTM are recomputed using the same principles as in the birth case but with more states.

5.2.2 Conquer

Conquer works in the same way as a Revolution, but the condition for it to happen is different. Each State Machine can randomly decide to conquer a different State Machine. The probability of the State Machine i to conquer the State Machine j at a certain time step is:

$$P = P_i^c \cdot (1 - \text{MTM}_{ij}) \cdot (1 - \text{MTM}_{ji}) \quad (3)$$

5.3 Other interactions

There are other interactions that are either spoilers or that we are investigating right now. We will publish the results in Nature or in Sigbovik 2021. Who knows.

6 Hierarchy

We now define common variations of the Empire Machine depending on the type of state considered.

Definition 6.1. A Planetary Empire Machine is an Empire Machine where the states are themselves Empire Machines.

Definition 6.2. A Galactic Empire Machine is an Empire Machine where the states are themselves Planetary Empire Machines.

Definition 6.3. A Multiversal Empire Machine is an Empire Machine where the states are themselves Galactic Empire Machines.

We now present a different formalization of the hierarchy of k -level State Machines using inductive definitions.

Definition 6.4. A 0-level State Machine is a single state Finite-State Machine with 0 probability (because we want to innovate).

Definition 6.5. A 1-level State Machine is a Finite-State Machine.

Definition 6.6. A 2-level State Machine is a Empire Machine.

Definition 6.7. A $(k + 1)$ -level (with $k \geq 2$) State Machine is a Empire Machine whose states are k -level State Machines.

7 Analyses

Through careful analysis we got to know of the awesomeness of this idea, see Section 8 for more details.

8 Theorems

Theorem 8.1. *Empire Machines can solve the Halting problem and therefore are models of hypercomputation.*

Proof. Proofs left as an exercise □

Corollary 8.1.1. *Empire Machines are awesome.*

Corollary 8.1.2. *Galactic Empire Machines are even better.*

Corollary 8.1.3. *Multiverse machines require further research and more funding.*

9 Relations to other complexity classes

Empire Machines win!

10 Relations to other decidability classes

Empire Machines win!

11 Pretty pictures

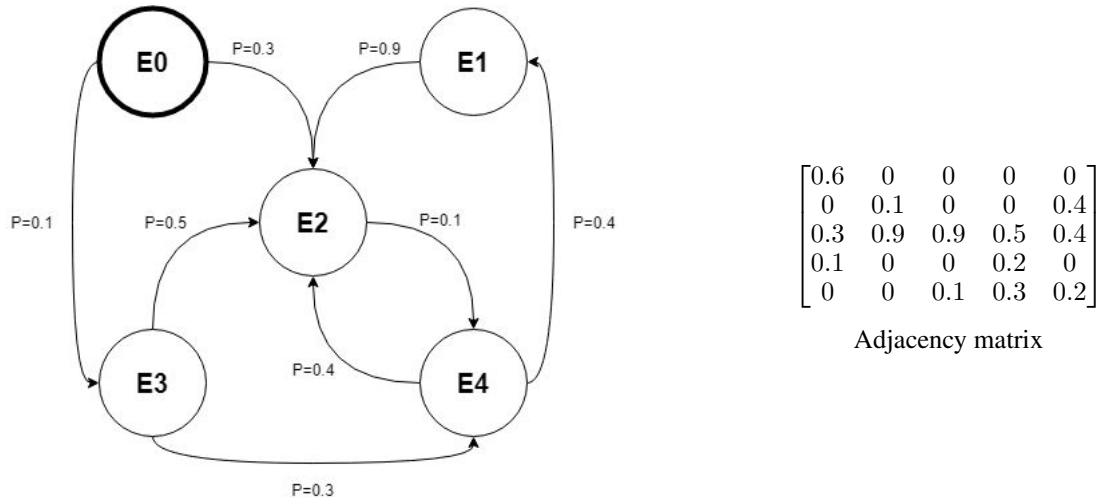

Figure 2: Unbalanced Planetary Empire Machine

Here we can see a normal Planetary Empire Machine. However, too many probabilities flow into Empire 2, whereas very few flow out of it. This will cause the remaining empires to wage war against Empire 2, and destroy it. Here is the end result:

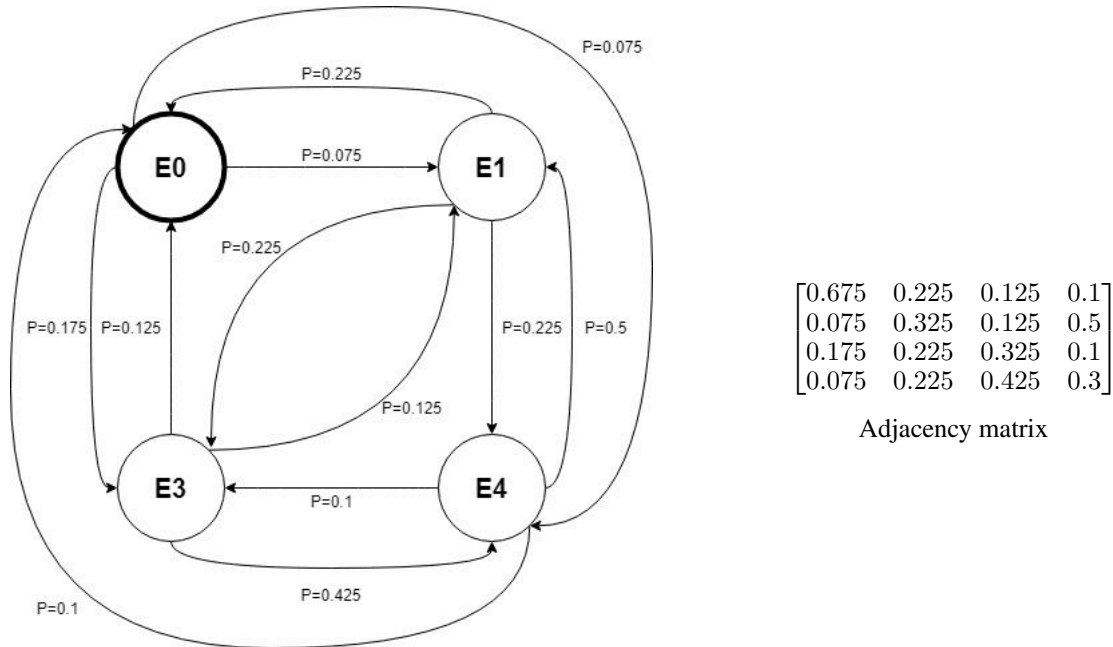

Figure 3: Balanced Planetary Empire Machine (after violence)

The probabilities that used to go into E2 are now divided between all the remaining empires. This will ensure the Planetary Empire Machine is peaceful again. Of course, until new empires appear or old empires gain too much power, in which we are back to the beginning, but oh well.

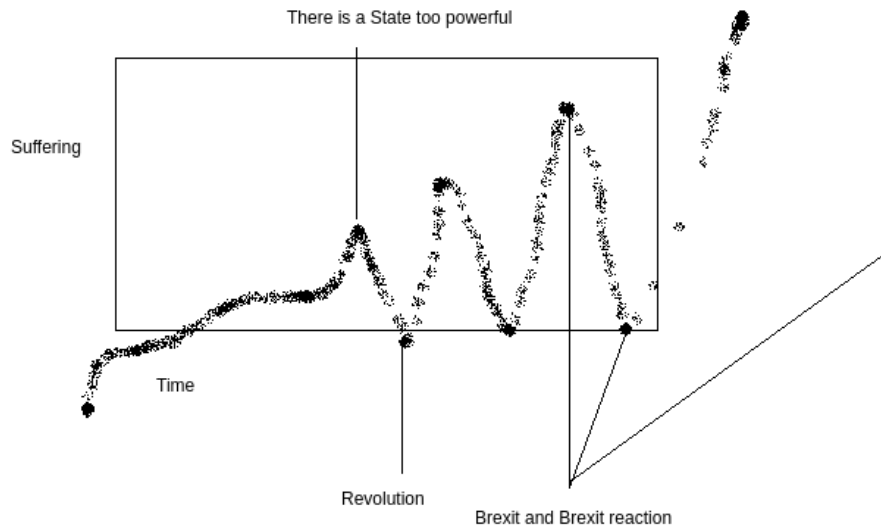

Figure 4: Plot showing evolution with respect to time of a complexity measure (specifically suffering which is also called productivity by economists), we have manually annotated relevant events to help explain the inflexion points, the interested reader may notice the non-monotonicity with respect to time.

12 Empirical evidence for the superiority of Empire Machines

Nobody cares

13 Potential moral implications

Nobody cares (again)

14 Benchmarking

Nobody cares

15 Reproducibility

The authors make no guarantee that this is reproducible or worth anyone's time. Someone tried to make code [6] but we do not know if it matches the content here.

16 Future work

Magic

17 Conclusion

Happiness

18 Are there page numbers?

No!

References

- [1] A.A. Márkov. "Rasprostranenie zakona bol'shih chisel na velichiny, zavisyaschie drug ot druga". Izvestiya Fiziko-matematicheskogo obschestva pri Kazanskom universitete, 2-ya seriya, tom 15, pp. 135–156, 1906
- [2] https://en.wikipedia.org/wiki/Finite-state_machine
- [3] SIGBOVIK 2019 <http://sigbovik.org/2019/proceedings.pdf>
- [4] RLIRFO <https://github.com/juancarlosmv/RLIRFO>
- [5] A place where we learnt that people die when they are killed https://typemoon.fandom.com/wiki/Fate_series
- [6] <https://github.com/juancarlosmv/MachineEmpires>



CONFIDENTIAL COMMITTEE MATERIALS

SIGBOVIK'20 3-Blind Paper Review

Paper 16: Empire Machines and beyond

Reviewer: The authors' professors

Rating: $-\infty$

Confidence: As confident as the fact that the sun shines during solar eclipses

This is the best thing ever (after Turing machines and working quantum computers).

Artificial General Relativity

PABLO SAMUEL CASTRO

DAD, Joint Organization of Knowledgeable ExpressionS
@pcastr ← that's my Twitter handle

Abstract

We (well, I) introduce a New Field In Science which we (I mean I) call Artificial General Relativity. We (here I really mean 'we') have all heard of General Relativity and how it revolutionized our understanding of the world around us. Einstein's work, although pivotal, failed in one crucial aspect: although it allowed us to describe gravity and spacetime, it did not allow us to control them. In this paper I (switching to 'I' to avoid sounding pretentious with 'we') introduce Artificial General Relativity (AGR) which, when achieved, will allow us to control gravity and spacetime. I present a set of practical approaches to achieve AGR which serve as reasonable baselines for future work.

I. INTRODUCTION

In the early 20th century Albert Einstein introduced the general theory of relativity, also known as General Relativity (GR) (Einstein, 1915, 1916). This pivotal work broke the mental barriers between space and time, demonstrating that they are incredibly intricately intertwined, interrelated, immersed, in the infinitely immense *spacetime*. This theory has allowed us to explain the majority of large-scale gravitational experiments thus far observed, as well as implying the existence of majorly-cool things like black holes. The latter has had major implications not just in Theoretical Physics, but also in Science-Fiction writing (Ferrie, 2016).

Central to GR are the Einstein Field Equations (EFE), which relate the spacetime geometry to the distribution of the matter it contains (Einstein, 1915):

$$R_{\mu\nu} - \frac{1}{2}Rg_{\mu\nu} + \Lambda g_{\mu\nu} = \frac{8\pi G}{c^4}T_{\mu\nu} \quad (1)$$

where $R_{\mu\nu}$ is the Ricci curvature tensor, R is the scalar curvature, $g_{\mu\nu}$ is the metric tensor, Λ is the cosmological constant, G is Newton's gravitational constant, c is the speed of light in vacuum, and $T_{\mu\nu}$ is the stress-energy tensor (Wikipedia, 2020a). In keeping with the best practices of scientific research, I disclose that I

do not know the meaning of most of the terms I just introduced. However, what is important is to note is the equations' *structure* as well as the values which are *constants*: Λ , G , c , and π . We will come back to these equations below.

i. The First Shortcoming

A well-recognized shortcoming of GR is that it has not been able to be reconciled with Quantum Physics (von Neumann, 1955, Ferrie, 2017), eluding the dream of a Grand Unified Theory of Everything. More specifically, most quantum field theories are defined on a flat Minkowski space (Wikipedia, 2020b), which can cause inconsistencies with the curved spacetime of GR. Although quantum field theories have been developed for curved spacetime, these are only under specific conditions. The complete unification of these two main physical theories remains an open problem.

ii. The Second Shortcoming

A less known shortcoming of Einstein's GR is that it is a powerful *descriptor*, but not a *controller*. We are still unable to control the force of gravity during basketball games, the speed of the passage of time during finals, nor reduce the gravitational lensing effect during

astronomical observations. In other words, we are passive observers of a partially-understood physical system. Einstein famously quipped that “god does not play dice with the universe”; perhaps that is true, but what if *we* could be the ones throwing the dice?

A common question readers may ask themselves is: *Why are the equations in (1) so complicated?* While the answer to this question is beyond the scope of the present work, we (yes, you and me) may ask ourselves a related question: *Can we make those equations simpler?* To quote Barack Obama: YES WE CAN!

II. CASTRO FIELD EQUATIONS

I will simplify Equation 1 via the following steps.

1. **Get rid of the cosmological constant.** Einstein famously called Λ “the biggest blunder [he] ever made”, so I will start by setting it 0.
2. **Just use matrices!** Tensors are hard to visualize, so let’s just use matrices in \mathbb{R}^4 (3 spatial dimensions, and one for time)!

The above simplifications produce the CAstro Field Equations, or CAFE for short:

$$\hat{R} - \frac{1}{2}R\hat{g} = \frac{8\pi G}{c^4}\hat{T} \quad (2)$$

Where \hat{R} , \hat{g} , and \hat{T} are all 4D matrices. I am now ready to present the first theoretical result of this paper.

Theorem 1. *The set of equations described in (2) are simpler than those described in (1).*

Proof. This proof is presented in two parts:

Number of terms: The system of equations in (1) has 10 terms, whereas the system of equations in (2) has 8.

Simplicity of terms: Both sets of equations use the same real-valued scalars, so it suffices to compare the non-scalar terms. In (1) they are all tensors, whereas in (2) they are all just 4D-matrices. Given that tensors generalize matrices, the result follows. \square

In addition to Theorem 1, it goes without saying that CAFE is a strictly superior acronym to EFE.

III. TO QUANTUM OR NOT TO QUANTUM?

In this section I directly address The First Shortcoming described in the introduction: how to reconcile GR with Quantum physics. Given that I am adopting the tried-and-tested approach of simplifying things, I make the following assumption.

Assumption 1. *Really small things behave exactly like really big things.*

Under this assumption, there is no longer any need for Quantum physics, and the inconsistency vanishes. I address two natural questions that may arise:

- *Isn’t this a really strong assumption?* The vast majority of the world’s population has never seen anything at the quantum scale. So: no.
- *Why didn’t past physicists make this assumption?* Although I cannot say with certainty, I believe this may be a case of “mathiness” (Lipton and Steinhardt, 2019): as physics equations kept on getting harder and harder to understand, physicists had an incentive to continue making things more complicated.

IV. ARTIFICIAL GENERAL RELATIVITY

I now formally introduce Artificial General Relativity (AGR).

Definition 1. *A universe is described by Artificial General Relativity when Assumption 1 holds, and CAFE perfectly relates the geometry of the universe with the distribution of the matter it contains.*

A critic may naturally question: *could such a universe even exist?* Rather than taking this as a criticism, I invite readers to take this as an *invitation*: Let’s build a universe where this holds!

This is the crux of the choice of the word ‘Artificial’: *we must create the universe that is consistent with AGR*. An astute reader may then observe that desire alone is not enough: what evidence do we have that this is even possible? Clune (2019) argued that Darwinian evolution can be viewed as a general-intelligence-generating algorithm, and serves as an existence proof that the concept of general-intelligence-generating algorithms can work. I follow a similar approach to introduce the second main theoretical result of this work.

Theorem 2. *There exists a universe that is described by AGR.*

Proof. The proof naturally follows by noting the following:

1. Our universe seems to largely be described by General Relativity
2. We have computers that can create virtual universes satisfying arbitrary mathematical equations
3. It has been argued multiple times that we actually live in a computer simulation (Wachowski and Wachowski, 1999, Google, 2020)
4. Theorem 1.

□

V. EXPERIMENTS

In this section I provide some simulations and experiments as both proof-of-concept and as baselines for future work.

i. Simulation

In keeping with reproducible research, I made a colaboratory notebook where you can plug in CAFE equations and see colorful plots: <https://tinyurl.com/s5bxbbs>. I display a sample run with structured matrices in Figure 1, which results in structured projections. This provides empirical evidence for Theorem 2, its structural regularity, and will hopefully motivate others to develop more sophisticated simulations.

ii. Black holes

In this section I propose a novel way of presenting experimental evidence: interactively! As far as I know, this is the first time a Real Scientific Paper has presented an interactive experimental section. As was previously mentioned, black holes are majorly-cool, so I would like to present method for approximate black holes in Algorithm 1. This method is based on the fact that black holes are simply mass that has been enormously compressed.

Algorithm 1 How to approximate a black hole

Input: Any physical object O
Input: A compressing device C
 $\hat{O} \leftarrow O$
while You still have energy **do**
 $\hat{O} \leftarrow C(\hat{O})$
Return \hat{O}

As a simple application of this method, print this research paper, take the first page (this will be O), and crumple it as much as you can (your arms are acting as C). I guarantee the paper now has a stronger gravitational field. The stronger you are and the larger the paper you compress, the closer to a black hole it will be.

VI. CONCLUSION

Many believe that achieving Artificial General Intelligence (AGI) will solve all the world’s problems (but how, specifically, is not clear). I claim something similar, but more ambitious: building a universe consistent with AGR will solve all the *universe’s* problems (but it’s not clear yet if it will be our universe or the new one). Artificial General Relativity, which I’ve introduced here backed by both theoretical results and convincing empirical evidence, promises to be an exciting new area of scientific thought. It is fitting that this is happening in 2020, the start of a new decade! I look forward to what new research in this field this decade will bring.

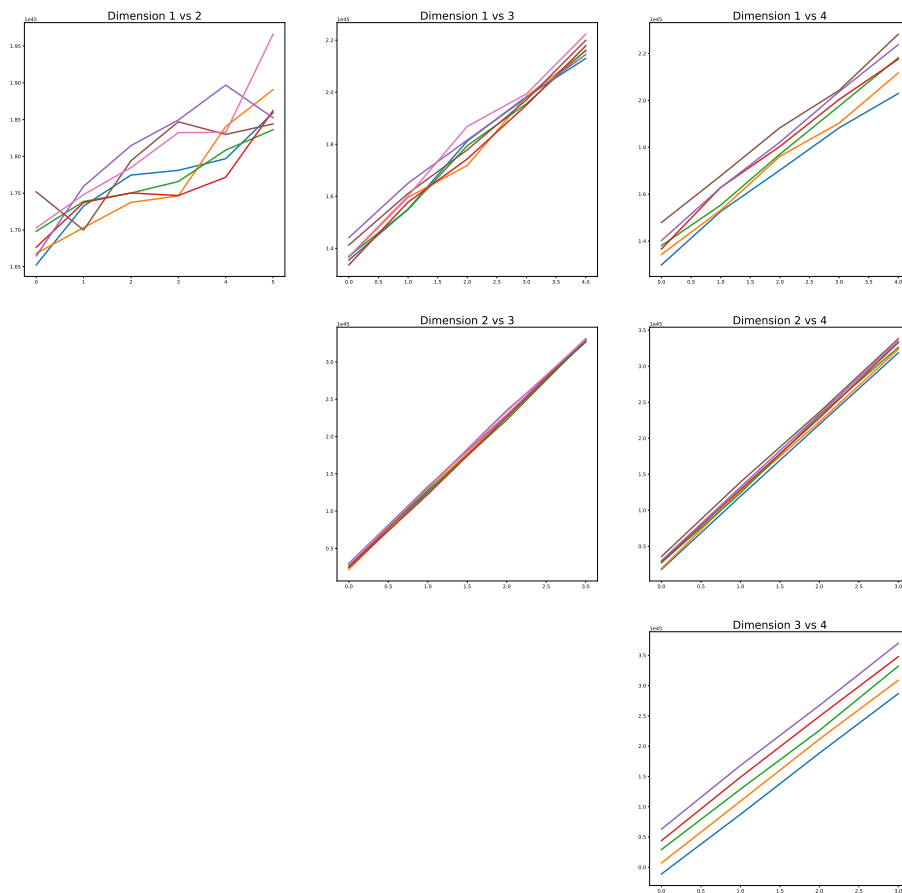

Figure 1: Sample projections of \hat{T} from the CAFE equations, when solving with structured matrices.

VII. ACKNOWLEDGEMENTS

For their help in correcting this manuscript, I would like to thank my esteemed colleagues in the Joint Organization of Knowledgeable ExpressionS. In keeping with SIGBOVIK's triple-blind review process I will only use their official company titles: MOM, AUNT, UNCLE, MARLOS C. MACHADO.

REFERENCES

- Jeff Clune. Ai-gas: Ai-generating algorithms, an alternate paradigm for producing general artificial intelligence. *CoRR*, abs/1905.10985, 2019. URL <http://arxiv.org/abs/1905.10985>.
- Albert Einstein. Die Feldgleichungen der Gravitation. *Sitzungsberichte der Preussischen Akademie der Wissenschaften zu Berlin*, pages

844–847, 1915.

Albert Einstein. The Foundation of the General Theory of Relativity. *Annalen der Physik.*, 354, 1916.

Chris Ferrie. *General Relativity for Babies*. CreateSpace Independent Publishing Platform, The Internet, 2016. ISBN 9781533181121.

Chris Ferrie. *Quantum Physics for Babies*. Sourcebooks Explore, The Internet, 2017. ISBN 9781492656227.

Google. *Do we live in a computer simulation?*, 2020. URL <https://www.google.com/search?q=do+we+live+in+a+computer+simulation>.

Zachary C. Lipton and Jacob Steinhardt. Troubling trends in machine learning scholarship. *Queue*, 17(1), February 2019. ISSN 1542-7730. doi: 10.1145/3317287.3328534. URL <https://doi.org/10.1145/3317287.3328534>.

John von Neumann. *Mathematical Foundations of Quantum Mechanics*. Princeton University Press, 1955. ISBN 978-0-691-02893-4.

Lana Wachowski and Lilly Wachowski. *The Matrix*, 1999.

Wikipedia. *Einstein field equations*, 2020a. URL https://en.wikipedia.org/wiki/Einstein_field_equations.

Wikipedia. *Quantum field theory in curved spacetime*, 2020b. URL https://en.wikipedia.org/wiki/Quantum_field_theory_in_curved_spacetime.



CONFIDENTIAL COMMITTEE MATERIALS

SIGBOVIK'20 3-Blind Paper Review

Paper 14: Artificial General Relativity

Reviewer: Reviewer Number Two-and-a-half

Rating: Humbug, all of it!

Confidence: At present, all things considered – and especially my vast background in computational heresy – I must say that I am about as confident regarding this review, as my uncle is that the quotes he posts on Facebook are indeed Einstein's. In other words, I am absolutely bloody* confident.

After carefully not-reading the paper, I have convinced myself that the experiments are probably lacking. Honestly, which paper would not merit from more extensive empirical verification that nonetheless fits in the same amount of space? This is just a well-known fact about the academic space-time continuum, and can therefore only be true for this paper as well.

Another key issue with the paper is that it does not seem to cite *any* of my own or my research group's papers! And I must ask: how on earth could the authors possibly have ignored such a key piece of related work? Our papers should be cited at least three times in any paper on this topic.

Finally, I would like to point out that the paper is ridden with spelling mistakes. Obviously, I am not asking the authors to be perfect, but ending perfectly innocent verbs with “-ize” instead of “-ise” and nouns with “-ization” instead of “-isation”? Depravity!

I cannot do anything but conclude that this paper is complete and utter humbug, and should be read exclusively by those who wish to have a good laugh.

*Yes, “bloody”, partially because I am indeed from across the pond, but mainly because I just slaughtered your paper. No, I am not in the least bit apologising; in fact I hereby offer the authors my two-fingered salute. Cheerio!

Lower Gauge Theory

Dead Duck or Phoenix?

March 31, 2020

Oscar I. Hernandez

Riverside, CA, 92507

oscar.hernandez@simons-rock.edu

Abstract

Gauge theory is used to describe the parallel transport of particles using connections on bundles. The use of higher gauge theory which uses 2-connections on 2-bundles to describe the parallel transport of points and 1-dimensional strings suggests the existence of a “lower gauge theory” which would apply $\{-2, -1, 0\}$ -categories to the study of parallel transport of lower-dimensional objects. We will explore such a theory and its applicability.

1. Introduction

While this may sound slick, it’s probably not worth pursuing a mathematical theory which aims to solve problems regarding physical objects of negative dimension.

2. Future Work

We encourage the reader to abandon this line of research, and focus instead on ordinary or higher gauge theory and their applications to physics and economics.

References

- [HGT] J. Baez and U. Schreiber Higher Gauge Theory *Hamburg Preprint ZMP-HH/05-25*. 2005. <https://arxiv.org/abs/math/0511710>
- [CPI] P. Malaney The Index Number Problem: A Differential Geometric Approach *Harvard University*. 1996.

Making Explicit a Constant Appearing in an Impossible Equation of Carl and Moroz

Matthew Weidner
Carnegie Mellon University

February 28, 2020

Abstract

Recently, Carl and Moroz [1] constructed a Diophantine (integer polynomial) equation for which it is impossible to decide whether the equation has any (integer) solutions. However, their presentation is not as explicit as it could be, instead involving implicitly defined polynomials spread out over many pages. In particular, they give a two page description of a crucial constant without bothering to explicitly compute it. We resolve this issue using a bit of Python, SageMath, and 878 MB of disk space.

1 Introduction

The Matiyasevich–Robinson–Davis–Putnam (MRDP) theorem [4] states that Diophantine equations (polynomial equations with integer coefficients) are “Turing complete”, in the sense that for any recursively enumerable set of integers S , there is a polynomial f with integer coefficients such that $S = \{n \mid \exists x_1, \dots, x_k \in \mathbb{Z}. f(n, x_1, \dots, x_k) = 0\}$. This famously implies that is undecidable to determine whether a Diophantine equation has any (integer) solutions, giving a negative answer to Hilbert’s Tenth Problem.

Another consequence is that it is in principle possible to take your favorite axiomatization of mathematics, such as ZFC set theory, and construct a Diophantine equation such that, within that axiomatization, one can neither prove nor disprove whether the equation has any solutions. Recently, Carl and Moroz [1] did exactly this for Gödel-Bernays set theory, which has the same set of provable statements about sets as ZFC [5]. That is, they describe how to write down an “impossible” Diophantine equation such that, within “mathematics as we know it”, one cannot prove or disprove whether it has a solution. However, their presentation is not as explicit as it could be—the equations are spread out over many pages, and some of them are not written explicitly as polynomials, instead involving polynomial functions of other polynomials.

It would be aesthetically pleasing to write down their impossible equation in an explicit, easily interpreted form. Such forms are known for a separate consequence of the MRDP theorem: just as one can construct universal Turing machines, one can construct *universal Diophantine equations*, which can be made to emulate any Turing machine by fixing some variable values. For example, there is a computable encoding of Turing machines as triples of integers (z, u, y) , and Turing machine inputs as integers x , such that the Turing machine corresponding to (z, u, y) accepts input x iff the following system of equations has a solution [3]:

$$\begin{aligned}
 elg^2 + \alpha &= (b - xy)q^2, & q &= b^{560}, & \lambda + q^4 &= 1 + \lambda b^5, & \theta + 2z &= b^5, & l &= u + t\theta, \\
 e &= y + m\theta, & n &= q^{16}, & r &= [g + eq^3 + lq^5 + (2(e - z\lambda)(1 + xb^5 + g)^4 \\
 & & & & & + \lambda b^5 + \lambda b^5 q^4)q^4][n^2 - n] + [q^3 - bl + l + \theta\lambda q^3 + (b^5 - 2)q^5][n^2 - 1], \\
 p &= 2ws^2r^2n^2, & p^2k^2 - k^2 + 1 &= \tau^2, & 4(c - ksn^2)^2 + \eta &= k^2, \\
 k &= r + 1 + hp - h, & a &= (wn^2 + 1)rsn^2, & c &= 2r + 1 + \phi, \\
 d &= bw + ca - 2c + 4a\gamma - 5\gamma, & d^2 &= (a^2 - 1)c^2 + 1, & f^2 &= (a^2 - 1)i^2c^4 + 1, \\
 (d + of)^2 &= ((a + f^2(d^2 - a))^2 - 1)(2r + 1 + jc)^2 + 1.
 \end{aligned}$$

A related fun result is the statement that any provable mathematical statement has an alternative proof consisting of 100 additions and multiplications of integers [3, Theorem 5].

Our work is a first step towards putting Carl and Moroz’s equation into an aesthetically pleasing form. Specifically, we compute a constant which is defined implicitly in their work using two pages of equations, many of which are not true polynomials but instead involve polynomial functions of other polynomials.

2 The Impossible Equation and its Constant

Briefly, Carl and Moroz construct their equation as follows. Let \mathcal{L} denote the language of first-order logic with a single binary predicate symbol. First, they construct a polynomial $f(t, \vec{x})$ which is a Diophantine version of a computer program that checks whether \vec{x} encodes a proof of t in \mathcal{L} . Thus for any statement P of \mathcal{L} , letting t_P be their integer encoding of P , P is provable in \mathcal{L} iff there exist integers $\vec{x} \in \mathbb{Z}^{14558112}$ such that $f(t, \vec{x}) = 0$.

Next, they explain how to write down the integer encoding of the statement “the axioms of Gödel-Bernays set theory imply a contradiction”.¹ Specifically, the authors encode the statement

$$A_1 \Rightarrow (A_2 \Rightarrow (\dots (A_{15} \Rightarrow (\forall x. x \in x)) \dots)), \tag{1}$$

where A_1, \dots, A_{15} are the axioms of the theory, and \in is the binary predicate symbol of \mathcal{L} . The axioms are meant to model that \in denotes ordinary set inclusion, and in particular, they imply that $\forall x. x \in x$ is false, so this statement is provable iff Gödel-Bernays set theory is inconsistent. Thus by Gödel’s second incompleteness theorem [2], the statement can be neither proved nor disproved within Gödel-Bernays set theory, hence within all of ordinary mathematics.²

In the author’s notation, the integer encoding of (1) is denoted $f_{15}(\vec{a}, 3)$, where f_{15} is defined in equation (5) on page 49, and \vec{a} is the vector of the values a_1, \dots, a_{15} defined in Section 8.

Our computation computes this $f_{15}(\vec{a}, 3)$.

3 Computation

Our program³ is a straightforward Python transcription of the equations defining $f_{15}(\vec{a}, 3)$ in [1]. One exception is that we re-order the axioms in (1) by the magnitude of their integer encodings. This helps to keep the magnitude of the overall result small, since the magnitude of $B \Rightarrow C$ is approximately the square of the sum of the magnitudes of B and C . With the original axiom ordering, the program ran out of memory before finishing despite having 16 GB of RAM.

While the program could be run in Python, we actually ran it using SageMath [6]. This is about 100× faster due to SageMath’s use of the GMP library for integer arithmetic. It takes 11 minutes to run on the author’s CMU-issued laptop.

The resulting value is 877,757,576 decimal digits long.

4 Result

We now include as many digits of the result as the editor will allow. We hope the reader finds its aesthetics more pleasing than the original presentation in [1], perhaps even on-par with the universal Diophantine equation reproduced above. The full result is available on a flashdrive by request from Gates 5005.

¹They use Gödel-Bernays set theory instead of the better-known ZFC set theory because Gödel-Bernays has only finitely many axioms, whereas some of ZFC’s “axioms” are actually axiom schemas which describe infinite sets of first-order statements.

²Unless the axioms are inconsistent, in which case we have bigger problems to worry about!

³http://mattweidner.com/diophantine_impossible/diophantine_impossible.sage



CONFIDENTIAL COMMITTEE MATERIALS

SIGBOVIK'20 3-Blind Paper Review

Paper 8: Making explicit a constant appearing in an impossible equation of Carl and Moroz

Reviewer: Dos Sleddins, Time Detective

Rating: Inevitable Accept

Confidence: 3.999991 - $\int_{2020}^{2071} \tau(y) dy$

(where τ is Longwood's temporal inference decay function; see SIGBOVIK 2059.)

Hey there, Harry. Long time no review—or at least, from your reference frame, anyway. I've been hopping the chrono-eddies left and right, strange and charm (in far excess of the BLCSC's recommended subjective-yearly intake, I might mention), in search of the beating heart of SIGBOVIK's research causality web. It's this paper.

I made sure Reviewer Two woke up in a good mood that one dreary March morning in 2010. I snuck subtle citation formatting bugs upstream into 2033's new typesetting software. All to nudge your legacy in the right direction for Ringard's Paradox to finally be solved in 2071. 2020's triple-blind causality protections were the hardest to crack of all, and for that I thank the PC; I truly do—but for reasons that would undo my own existence were I to utter them here.

And now that I'm now, it almost feels like a formality to write a review for the Nexus itself. Nevertheless:

Program committee, you must accept this paper. No; it is simply inevitable that you *will* accept it. Although it may seem to be of totally unrelated subject matter, this paper lays the groundwork for Highest-Order Logic *and* for the Lambda Timecube. The inspiration it draws from β -Reduction Hero is both unprecedented and unsucceded, although this author was too humble to deign to spend even a footnote on it. Its multidisciplinary take on the Call for Papers will have opened fifteen new realms of study for Bovicians worldwide in the years to come.

It could do with a few more explanatory pictures.

First time y'all been fully decorporealized this year, huh? Well, ya pulled it off fantastic despite the circumstances. Have hope—it gets better. Nice page numbers by the way.

Security

19 Determining the laziest way to force other people to generate random numbers for us using IoT vulnerabilities

mathmasterzach, StarChar

Keywords: babies, information theory, randomness, entropy, April fools, hacking, the law, coffee shops, smart-toasters

20 Putting the ceremony in “authentication ceremony”

Camille Cobb, Sruti Bhagavatula

Keyword: authentication, ceremony, fun, security, weddings

Determining The Laziest Way to Force Other People to Generate Random Numbers For Us Using IoT Vulnerabilities

mathmasterzach

Villanova University
zachdestefano[at]gmail.com

StarChar

Villanova University
mholmblad13[at]gmail.com

Wednesday, March 32, 2020 Anno Domini

Abstract

The idea of this project is simple. Hack into a nearby IoT device and pull some random numbers off of it. This device can be located either in the same room as you, or your next-door neighbor's house. Anything from the password of their lock screen to the neighbor's baby monitor. The goal is to take privacy-violating hacks on IoT devices and use them just for random number generation in a legally dubious way while also being as lazy as possible.

1 Introduction

In the past decade, the number of IoT devices in the world has been increased at an exponential rate [1]. There has been a similar exponential increase for generating random numbers for use in cryptography, Monte Carlo simulations, digital simulations of the Monte Carlo Casino, RPGs, generating hashes, lottery tickets, picking people to send off to war, and grading papers.

These random numbers are secure against side-channel attacks because the best defense is a good offense. Also, if someone else had the same access to your IoT device that we have using this framework, then you should have bigger concerns about security than someone knowing your random numbers [10].

2 Background

In order to understand this new discovery. The reader needs to understand a couple simple information theoretical concepts of high importance. We strongly recommend a full understanding of the following concepts before approaching this paper: reading and the implications of the asymptotic equipartition property for discrete-time finite-valued stationary ergodic sources.

2.1 Random Numbers

Two, ten, a million, one, sixty-three, four, four, four. These are some random numbers. Rolling a die is considered truly random. Creating a good random number generator (RNG) is a popular theoretical problem that was originally formally addressed by Donald Knuth. [4] RNGs require a seed in order to generate numbers. This isn't a seed that is used to grow a plant, but a seed for creating hundreds of thousands of numbers. It is addressed later on how our random numbers are generated.



Figure 1: An example of older random number generation technology

The goal of generating random numbers is always for them to be truly random. Unfortunately, many attempts at true randomness have often ended up being the creation of significant pseudo-random number generators (pRNG). There is a well-known statistical test suite made by Robert G. Brown known as Dieharder [3]. Many pRNGs have been tested using this test suite. However, it is still unknown whether a true RNG actually exists.

2.2 IoT Vulnerabilities

An IoT (Internet of Things) device is a device which has at least one sensor and is connected to the internet. These devices are useful for various levels of home automation; however, we have discovered an alternate, more powerful set of features implicit in these devices. None of the manufacturers that we surveyed list this feature in their device capabilities, so we have taken on the task of making these "hidden features" more known to the public while demonstrating the extent and effectiveness of these features. As a result of our research, we have discovered that most IoT devices have a built-in random number generator that anyone can use with proper hacking. We are currently unsure about why these truly marvelous features are not listed anywhere by the manufacturers.

3 Methods and Results

We will now demonstrate various theoretic frameworks for using IoT devices to get random numbers from other people without them knowing. We will discuss how to get random numbers from other people's babies while they sleep, from their phone passcodes, and from their general habits (particularly those involving toasters). We will assess each of these sources for their information theoretic properties to determine the rate of information production by these stochastic sources so we might make proper comparisons between their information entropy [6].

Due to budget cuts and time constraints, any proper calculations of entropy have been replaced with approximations by using a large sample of data gathered from the source and compressed with 7-Zip (7-Zip implements the Lempel-Ziv-Markov chain-Algorithm). Using

the Lempel–Ziv theorem which states that: the algorithmic entropy of a file is bounded by its Shannon entropy (or something like that more or less), we can assume that our experimental method of zipping large quantities of data suffices to produce a reasonable ballpark estimation of the entropy of our sources. [2]

To quantify our results and for a proper comparison, entropy per bit is only one part of the formula. We must also quantify the amount of work/time it takes to acquire this entropy so that we can determine the optimal way to get entropy with as little effort as possible. We have designed the following formula to help us calculate and ultimately maximize the number of shannons per joule, the amount of entropy per bit as a function of personal energy.

$$\frac{\frac{\text{bits of entropy}}{\text{bits of information}}}{\frac{\text{gathering work}}{\text{time}} + \text{activation energy}}$$

Given that there have been no prior references to this important, shannons/joules unit, we have named this new important unit lazy-lokis which will be abbreviated in this paper as zk.

3.1 Secretly Using People’s Babies for Random Numbers

A baby is a... wonderful noise maker. They make a lot of different sounds at different volumes and frequencies. This is perfect when converted to numbers. Thus, the baby’s cry is a successful RNG, because it is practically impossible to guess what numbers the baby will produce next when they cry.



Figure 2: Example of a baby in a sophisticated rig for measuring information theoretic properties

In order to assess the information theoretic properties of babies as noise sources for random number generation, we must appraise and quantify them as sources of entropy. Unfortunately, we were told that, "under no circumstances," would our Institutional Review

Board approve using human subjects for this project, but in order to advance science, we undeterred by this bureaucratic hurdle, downloaded an open dataset of baby cries from GitHub to estimate the information theoretic properties of babies.

The "donate a cry corpus" is a dataset of baby cries which separates all baby cries into a subset of the Dunstan Baby Language categories for cries (hungry, needs burping, belly pain, discomfort, tired) and further qualifies the cries into sex (male, female), and age buckets (0 to 4 weeks, 4 to 8 weeks, 2 to 6 months, 7 month to 2 years, more than 2 years) [9]

Our results are documented in the following table with the units being the fraction of the number of bits of entropy in each bit of data:

Data	0-4wk		4 - 8wk		2 - 6mo		7mo - 2yr	
	M	F	M	F	M	F	M	F
Hungry	0.7176	0.6618	0.6576	0.6904	0.7257	0.7211	0.7038	0.6378
Needs Burping	0.6920	N/A	0.9034	0.7285	0.8900	0.7337	N/A	0.7295
Belly Pain	0.8153	N/A	0.5767	N/A	0.7062	0.6948	0.6571	N/A
Discomfort	0.3763	N/A	0.6964	0.6719	0.7068	0.8231	0.8524	N/A
Tired	0.7609	0.6787	0.6685	0.6383	0.7189	0.6436	0.7230	N/A
Average	0.6724	0.6702	0.7005	0.6823	0.7495	0.7233	0.7341	0.6837

Assuming that all five states that a baby can be in occur with equal frequency, we can assume that the information entropy of a baby's cry is approximately .7020. That is to say that we can expect to get .7020 bits of entropy on average for every 1 bit we siphon from baby's cries. If we have the fortune of selecting a specific baby for random number generation, we should prefer to choose a male baby 2 months or older, although this does not give a major increase in entropy over other categories.

Future research in this area can involve provoking babies with light and sound features on the cameras to see if this increases the entropy of their cries, and expanding our dataset to include categories for which there was no data available to us.

3.2 Secretly Using People's Habits for Random Numbers

Linux uses various sources such as timing in between user interaction events as entropy which is stored in /dev/random to be used later, but when this runs out of entropy it is a blocking operation while it waits for more entropy. This is relatively limited because Linux machines are often lifeless servers connected to the internet running from within a dark room for decades at a time with minimal human interaction.

These machines are deprived of the warmth and love required to create random-ish numbers, but it is possible to, with the power of modern technology, allow these machines to experience the joy of an "endless" stream of random numbers without any need for warmth or love. This process involves taking devices that individuals use directly more habitually such as smart toasters, smart water bottles, smart fridges, and smart crockpots, and collecting and transferring the human interaction information so it can be used for random number generation.

Now perhaps you might begin to protest and say, /dev/urandom is universally preferred over /dev/random and neither offers better randomness because they are ultimately run through CSPRNG but /dev/urandom is better because it doesn't have the blocking issue and thus breaking into other people's toasters is a wildly unnecessary and ethically dubious

way to get random numbers. We answer that strings of true random numbers are like beautiful heartfelt poems and thus you are a joyless husk of a human being to believe that the pseudo-random numbers that a lifeless computer generates are in any way of the same caliber.

Human interaction with these devices on the macro level is largely predictable, ex. toaster used at breakfast same time Monday-Friday within a 10-minute window with the time dial set to about 1 minute or fridge opened at precise 5-minute windows during the day to get drinks, snacks, and frozen pizzas, but at a more precise level, the variations within these patterns is completely random. The number of milliseconds above or below normal modulus some desired small value has an entropy value that approaches 1 bit per bit on analog toaster input. There is the first issue for us that this exceedingly high-quality randomness is only found in a smaller quantity; however, this is not the biggest issue with this method. Many IOT devices in this area have shifted away from allowing this error through digital interfaces. This poses a potential risk, but for now, it appears to be safe to use this method in production.

3.3 Someone's Lock Screen Password

Encryption often involves a salt, which is

Definition 3.1 (Salt). Random data that is used as an additional input to a one-way function that hashes data, a password or passphrase.

Salts are generally small numbers. Frequently on the iPhone, a user's password for their lock screen is 4 numbers. The iPhone is the most common kind of phone. This is a perfect salt for an encryption algorithm. Thus, the lock screen code is a very useful set of random numbers. Plus, outside of general cases and permutations of the classic 1234 password, phone passwords have an extremely wide variety.

The issue arises when we discuss how to get these passcodes. Let's say we're inside the comfort of our home. Then the easiest way to get the passcode is through the neighbor's WI-FI or picking up the signal off a nearby cell tower, which is a ton of work. An easier method is to go to the nearby coffee shop across the street because everyone connects to that coffee shop's free WI-FI capabilities. The process is simple, walk in the coffee shop, buy a coffee, sit at the corner table and act like you're writing the next great novel like most people. Meanwhile, lots of phones and people come through, and we harvest lots of phone passwords. As optimal as this is, lots of people visit the same coffee shop. Thus, to keep the randomness, we need to frequent many different coffee shops. The amount of zks that this will cost is exponential.

Considering the cost, these must be incredibly random numbers to be worth our time, and as it turns out, using a collection of passcodes sorted by frequency [5] we calculate 13.2627 bits of entropy per symbol where symbols are the set of integers 0 through 9 which when the divided by the number of bits per symbol, gives us .9981 bits of entropy per bit of data.

4 Method Comparison

With the values above, we now believe ourselves to be adequately prepared to ask the question of which aforementioned source is best for random number generation. For comparison,

we will not use the raw entropy values, but instead, lazy-lokis to account not only for the optimality of the entropy of the source but also to account for the effort required to gather quantities of this data. The exact calculation of these values can be trivially done with the data provided and our formula above, so this calculation has been left as an exercise to the reader.

We have performed these calculations, and have determined that the method which maximizes lazy-lokis is hacking into baby monitors. Though this method generates fewer bits of entropy per bit of information than some of the other methods such as passcode stealing or using toasters and fridges, the sheer number of bits per time and the ease of access puts it over the top by several orders of magnitude.

Perhaps a phone passcode contains more entropy, but to steal phone passcodes I have the tremendous activation energy of driving to a local public shop or gathering point, potentially purchasing a beverage at said location to appear inconspicuous, and making sure to hit a different location each time so that I am not sampling the same set of passcodes each time. Similarly, the time delay in waiting for individuals to use their toasters and fridges limits random generation to specific time intervals and collecting larger collections of random numbers relies on hacking into more devices and waiting for each of those. Thus for the purest form of distilled random numbers, toaster and fridge micro-input information, the cost of acquiring these numbers is also maximal.

The baby monitor approach, however, allows me to get a continuous stream of data from other people's homes throughout the world from the comfort of my own home. The activation energy cost approaches 0 as I have around 2 years worth of data that I can get from any individual baby without the baby's data becoming stale or predictable. There is, of course, the issue of having a male baby vs a female baby as there is no way to tell what kind of baby is in the household. This gets tedious to find out, but it's a lot more comfortable than going to the coffee shop and buying something to fit in with everyone else that is there.

5 Experimentation

Our non-existent lawyers have told us that to say that we DEFINITELY have NOT, do NOT intend to, and do NOT encourage experimentation with these methods; however, if one was to hypothetically attempt to test one of these methods there are various things that they could try.

The following case study discusses many ways that have worked in the past to remotely access any baby monitor's audio feed [7]. Using the national vulnerability database, it is trivial to find more examples on which the same methods are effective. We have been advised to say that we have NOT tried any of them and do NOT advocate taking a look at various methods for getting remote access to baby monitors and trying them for yourself.

We are not lawyers and carrying out any of these tests, (which we did NOT), would be a legal gray area because, according to the definitions of what constitutes a crime in the Computer Fraud and Abuse Act (United States Code 18 Section 1030), taking entropy from someone without them knowing via one of their smart devices does not appear to directly violate this act [8]. Seriously. Take a look. Then consult a lawyer just to be safe. And let us know what they say.

The closest thing to violating this act that we could find can be found in the statement: "knowingly and with intent to defraud, accesses a protected computer without authorization,

or exceeds authorized access, and by means of such conduct furthers the intended fraud and obtains anything of value, unless the object of the fraud and the thing obtained consists only of the use of the computer and the value of such use is not more than \$5,000 in any 1-year period” [8]. Considering that the thing obtained consists only of the use of the computer and the entropy we are gathering probably isn’t worth more than \$5,000 then you are PROBABLY safe, but then again, we aren’t lawyers.

6 Conclusion

Thanks to this careful research we have reached a number of practical conclusions about random number generation that we expect to be taught in every information theory class as early as next semester. Zerothly, the higher quality the random numbers are the rarer and more difficult they are to acquire. Firstly, ease of access and random number quality are inversely proportional which implies that the lazy-loki metric as a function of entropy is continuously decreasing on the open interval $(0,1)$. Secondly, male babies exhibit higher variance in entropy generation when compared to their female counterparts at all ages which lends evidence to the greater male variability hypothesis.

It can be trivially seen that in general using the cries of babies is the best option for collecting random numbers from other people and that the highest quality of random numbers are quite rare and come from smart toasters. It is left as an exercise to the reader to continue testing this idea.

References

- [1] A Cursory Google Search
- [2] Avinery, Ram *Universal and accessible entropy estimation using a compression algorithm* The Raymond and Beverly Sackler School of Physics and Astronomy, Tel Aviv University, 2019. Print.
- [3] Brown, Robert G. *dieharder* Duke University Physics Department, 19 June 2017. Web.
- [4] Knuth, Donald *The Art of Computer Programming Volume 2: Seminumerical Algorithms* Addison-Wesley, 1968. Print.
- [5] Miessler, Daniel *SecLists: The Pentester’s Companion* GitHub Repository, 2012. Data.
- [6] Shannon, C. E. *Prediction and Entropy of Printed English* Manuscript, 1050. Print.
- [7] Stanislav, Mark *HACKING IoT: A Case Study on Baby Monitor Exposures and Vulnerabilities* Rapid7, 2015. Print.
- [8] United States Legislative Branch *Computer Fraud and Abuse Act (United States Code 18 Section 1030)* Comprehensive Crime Control Act of 1984. Print.
- [9] Veres, Gabor *Donate a Cry Corpus* GitHub Repository, 2015. Data.
- [10] Wurm, Jacob *Security Analysis on Consumer and Industrial IoT Devices* Department of Electrical and Computer Engineering, University of Central Florida, 2016. Print.



CONFIDENTIAL COMMITTEE MATERIALS

SIGBOVIK'20 3-Blind Paper Review

Paper 4: Determining the laziest way to force other people to generate random numbers for us using IoT vulnerabilities

Reviewer: Anonymous

Rating: lukewarm, getting warmer

Confidence: Confident that the organizing committee are FOOLS

The paper is acceptable, if nearsighted in its understanding of the implications of its findings. HOWEVER the authors are NO WHERE as nearsighted as the organizing committee, which has provided me with the perfect vector for injecting as many page numbers as I please into the proceedings, allowing me to harass the proceedings chair under the full cover of anonymity. Behold, as I inform *everyone* that this is Page 1 of 1, equivalent to i in roman numeral, or 0x425d22427978b6bc28a67815c2a61353e20a5c91861a656ac8ca6faa79299ec0 under the numbering scheme described in Cryptographically Secure Page Numbering in L^AT_EX! Haha! Ha! Muahaha-haha!

Putting the Ceremony in “Authentication Ceremony”

Abstract: In this paper, we seek to make authentication ceremonies for secure messaging apps more fun and enjoyable by incorporating them into important events in people’s lives, e.g., as part of a wedding ceremony. We design and develop a prototype using highly computer scientific methods and evaluate its usability through an equally scientific user study of one of the author’s dads. We conclude that our proposed ceremonies are fun and not boring and the authors would totally do this ceremony if they ever needed to use a secure messaging app.

1 Introduction

Every day, over 100 billion instant messages are sent between users across the globe [2], sometimes about sensitive topics such as when I couldn’t poop the other night and told my mom I wasn’t leaving the house until the situation changed. Man-in-the-middle attacks, buffer overflows, and many other buzzwords mean that these messages are not secure. Thankfully, substantial work in the area of cybercryptography has offered solutions such as encrypted messaging.

One popular secure messaging tool, Signal, offers encryption. This is good. But there is still a risk that users are sending messages to an adversary rather than to the intended recipients. This is because the problem of *key management* has not been sufficiently solved. *Authentication ceremonies* is a term used to describe out-of-band key exchange, which ensures that the person in the phone is the person you know IRL.

Although *authentication ceremony* sounds like it would be a fun event, it is actually not fun at all. In fact, users avoid doing it and struggle to do it right, as demonstrated in prior work [12]. More recent research has sought to improve the “usability” of the “user in-

terface” on “Signal” so that it is less “confusing” with limited success [11]¹.

In this work, we seek to put the *ceremony* back into *authentication ceremony*. Or, rather, we seek to put it there, because as far as we know it has never been much of a ceremony. Instead of trying to improve the usability of a technical system, we instead tackle the problem of user motivation, incentive, and desire to use the authentication protocols. By amending the authentication ceremony such that it creates an opportunity to (1) foster human connection and deepen relationships, (2) (????), and (3) Do It For The ’Gram, we show that at least one user (i.e., the participant in our study) is probably at least a little more likely to successfully complete an authentication ceremony when we show him how to do it next week.

Our novel, cutting-edge ceremonies will revolutionize communication. Everyone will be happier, more secure, and less constipated.

2 Background

We are writing this paper while working from home, which means it is much harder to access University resources such as the ACM Digital Library. With that in mind, we present a thorough literature review based only on the abstracts of papers and their lists of cited papers, which are available without logging in. This is only a light departure from typical background sections; many readers may not even realize that best practices encourage actually reading the work you cite. In fact, the author writing this section of the paper has not even skimmed the parts that the other author wrote, so who knows if this is relevant – we definitely do not.

2.1 Established Types of Ceremonies

A selection of really fun ceremonies are shown in Figure 1, including weddings, Olympics opening cere-

Camille Cobb: Carnegie Mellon University
Sruti Bhagavatula: Carnegie Mellon University

¹ Actually, they were pretty successful, but that doesn’t fit with our narrative.



(a) Wedding Ceremony



(b) Opening Ceremony



(c) Graduation Ceremony



(d) Signal Authentication Ceremony (current)

Fig. 1. Most ceremonies are fun and meaningful. The Signal Authentication Ceremony is boring.

monies, and graduation ceremonies. Not all types of ceremonies are fun. For example, for some reason the SIGGRAPH ’19 opening ceremony has an ACM Digital Library entry [6] and was almost certainly less interesting than the Olympics opening ceremony.

We cite one additional paper because it was published in a computer science venue and has the word “ceremony” in it. It talks about how to 3-D print spoons for Japanese tea ceremonies [9]. We decided not to prototype a ceremony that involves using phones as tea spoons, because not all phones are waterproof and almost no phones have a concave shape that would be amenable to spooning tea. However, fast-moving advancements in smartphone technology may change this landscape and make tea ceremonies attractive for future work in being adapted for use as authentication ceremonies.

2.2 Secure Messaging

This paragraph is copied and pasted from an email a colleague sent after I asked them to explain secure messaging to me. I didn’t read it, but he’s probably right:

For any secure messaging system, in order to do encryption you need to swap keys with whoever you’re communicating with. And when you’re exchanging keys, you need some way to authenticate/establish trust that the key belongs to who you think it does - like if you’re emailing public keys to each other, how do you know that it wasn’t intercepted and replaced with an adversary’s key? The only real way we have to do this, is either to trust some third party authority (like certificate authorities, for web/HTTPS), or to do it in person.

Just because the word “party” appears four times on the Wikipedia page for “key exchange” does *not* mean that it is a party [3]. The one potentially fun type of authentication ceremony precedent is key exchange parties. But when you Google “key party,” the results are *not* about authentication. In fact, the most prevalent search results when you search for key parties involve key exchanges that are the *opposite* of secure and do *not* encourage meaningful, deep human connection [4]. The problem is that you have to search for “key *signing* party,” but these really haven’t caught on: searching for “key signing party” yields *About 204,000,000 results (0.58 seconds)* whereas searching for just “party” yields *About 11,680,000,000 results (0.96 seconds)*. This means that under 2% of parties are key signing parties, but also demonstrates that there is substantial demand for

parties. Our work promises to significantly increase the search-result-share of authentication-related parties.

Here are a few papers that are *actually* about secure messaging, key exchanges, and authentication protocols, including a couple that involve studying the usability (or lack of usability) of Signal’s Authentication Ceremony [7, 8, 10, 11, 13?]. We omit any deeper discussion of these papers, not because they are not relevant, but because we started off way more ambitious in our plans to write this paper and are now running out of steam on this idea.

A screenshot of the Signal Authentication Ceremony is shown in Figure 1 (d), along with an artistic depiction of how boring it is, demonstrated by a photo of a person modelling for a stock photo.

2.3 Human Nature

In my intro psych class in college, I learned that sometimes people are happier when they have work to do, games become boring when they are too easy [1], etc. Also people want to connect with others. Although prior work concludes that the Signal Authentication protocol is too hard for users (one of these should be cited, but I don’t have time to figure out which one so I’ll cite all of them [7, 8, 10, 11, 13]), what if they were wrong and it was actually too easy and not fun enough? I mean, I haven’t fully read those papers, but I’m sure they reached the wrong conclusions.

3 Methods

3.1 Developing and Prototyping Novel Authentication Ceremony Protocol Designs

Okay, so really we just thought about this for a while. Then we explained our ideas in a lab meeting and other people came up with more ideas that we’ve stolen. We think they might have been joking, but we were serious. We narrowed down from our original three design ideas to three final design concepts, based on our intuition that having at least three designs to compare would sound really good in a final paper.

We prototyped each of these designs, as shown in Figure 2. The prototyping process and a sample of the unity candle authentication ceremony is shown in Figure 3. A ceremony involves a script of vows read out by

the authenticating parties. To create this script, we first found an existing unity candle ceremony script [5] and then used advanced HTML inspection skills to change the text on the website. Utilizing the developer console is how you know we are doing Computer Science Research™.

3.2 User Study to Evaluate Proposed Designs

We attempted to solicit opinions about authentication with the people in our lab but they simply laughed at us. As we were worrying about where we would get participants, one of the authors’ dads called them to warn them about the Coronavirus and we just decided to ask him while he was on the line instead.

We asked the author’s dad two questions: 1) what does it mean to you to authenticate? and 2) Are the people you want to exchange keys with also people you want to be closer with, emotionally?

As the final part of this study, we showed him the current Signal Authentication Ceremony and our prototypes (Figure 2).

We started with the Unity Candle Authentication Ceremony Design. In this system design, the authentication ceremony is incorporated into a wedding between two loved ones. With the underlying assumption that the two parties getting married trust each other and want to exchange keys, the exchange of keys must be executed after any official ceremony that officially weds two people. This method is generalizable to all wedding traditions regardless of beliefs and cultural alignment.

We then asked the dad the following questions: 1) Does authentication seem easier with this new method; 2) Would you feel closer to the other person with this new authentication ceremony method; and 3) Are you likely to do the new authentication ceremony with people in the future?

After this, the dad was tired of participating, so we made up results for our other two design ideas.

The participant was not compensated and did not give consent, but we did say “thank you” at the end of the call. These methods were not done with IRB approval, because when we called the IRB, they told us that this would not produce “generalizable knowledge” and so could not be considered human subjects “research.” Our study is based on data from one of the authors’ dads. Henceforth, we will refer to him simply as “the participant”.

4 Results

4.1 User Evaluation

The participant reported that authentication to him means logging into his email account online. When asked if he would want to exchange keys with people with whom he had an emotional connection, he appeared flustered and confused and said something about “darn technology”.

He was then asked to give his opinion on the new Signal authentication methods we proposed and he said he didn’t know what “Signal” was. We were not able to get any further data from the participant after this part of the study as he got too confused to be able to provide any meaningful answers. He was however excited by the wedding pictures and was eager to know who was getting married.

In Figure 4, we present made-up data that shows that the designs we came up with are better than any of the existing ideas. Based on the findings of our study, we concluded that our proposed authentication ceremony is probably good enough since who doesn’t like parties and ceremonies?

5 Future work

We hope to expand our new proposed authentication ceremony to other ceremonious occasions, beyond weddings, blood oaths, and graduations. In particular, our most immediate next step is to bring our authentication ceremony to childbirth so that a mother can bond to their newly born-child. Other potential expansions include children’s birthday parties and new year parties.

Now that we have authentication ceremonies, future work also needs to consider the case that two people would not like to be authenticated to each other anymore, i.e., an un-authentication ceremony might be necessary. This could occur as a result of a break-up or divorce. In this case, the parties would need to meet one last time to revoke their keys. Future work could explore the design of this mechanism.

Finally, there is a plethora of possible directions in applying ceremony to general security tasks. One example could be that when a computer requires its user to update its software, it doesn’t prompt the user at all during the process and instead instructs the user to take a calm relaxing bubble-bath while it is updating. Therefore, in this way, the user does not have to en-



(a) Unity Candle Authentication Ceremony



(b) Blood Oath Authentication Ceremony



(c) Graduation-Style Authentication Ceremony

Fig. 2. Prototypes for three novel authentication ceremonies.

officiantguy.com/unity-candle-wedding-ceremony/

Unity candles for a wedding ceremony by wedding officiant in Los Angeles, Chris Robinson.

During a Unity Candle AUTHENTICATION ceremony the mothers of the USER 1 and USER 2 light candles to the side of the unity (center) candle which represent the separate lives, families and experiences before the AUTHENTICATION day. After the exchange of vows, but before the exchange of rings the bride and groom take each side candle and light the unity candle together, uniting the families and experiences into one.

The wedding ceremony verbage for a unity candle can be the following, or a personalized unity candle ceremony can be created by you. This is spoken by the officiant, but of course, it can be spoken by the wedding couple:

Sample Unity Candle Wedding Vow - 1
 "USER 1 and USER 2, the two separate candles (ON YOUR PHONES) symbolize your separate lives, separate families and separate sets of friends. Please light the candles and that together you light the center candle.
 The individual candles represent your lives before today. Lighting the center candle represents that your two lives are now joined to one light, and represents the joining together of your two families and sets of friends to one."

OR

Sample Candle Ceremony - 2

Call Now to Talk to Chris:
 (310) 882-5039 or
 (562) 547-3255

WEDDINGWIRE COUPLES' CHOICE AWARDS 2019

the knot BEST OF WEDDINGS 2019 Preferred Officiant on the Knot

CLICK HERE TO SUBMIT YOUR MARRIAGE LICENSE INFO.

Contact Form

CLICK HERE TO CALL NOW

Elements Console Sources Network

```

    " The individual candles represent your lives before tod
    Lighting the center candle represents that your two live
    now joined to one light, and represents the joining toge
    your two families and sets of friends to one. "
    </p>= 18
    <p>OR</p>
    <p></p>
    <p></p>
    </p>= 18
    html body #content #primary #main #post-474 div-entry-content p (text)
    bride 5 of 10
    Styles Event Listeners DOM Breakpoints Properties Accessibility
    Filter :hov .cls +
    element-style {
    }
    p {
    margin-bottom: 1.5em;
    }
    html, body, div, span, applet,
    object, iframe, h1, h2, h3, h4, h5,
    h6, p, blockquote, pre, a, abbr, acronym,
    address, big, cite, code, del, dfn, em, font,
    ins, kdd, q, s, samp, small, strike, strong,
    sub, sup, tt, var, dl, dt, dd, ol, ul, li,
    fieldset, form, label, legend, table, caption,
    tbody, tfoot, thead, tr, th, td {
    border: > 0;
    font-family: inherit;
    font-size: 100%;
    font-style: inherit;
    margin: > 0;
    }
    
```

Fig. 3. A proposed script for a unity candle authentication ceremony, also demonstrating our meticulous prototype development process.

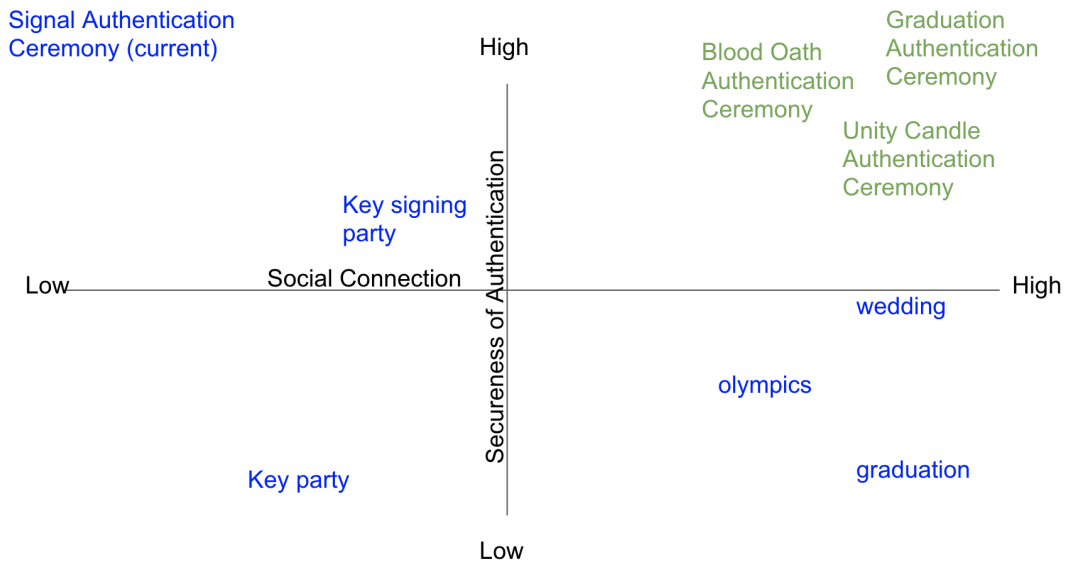

Fig. 4. As you can clearly see, the proposed authentication ceremony designs from this work (shown in red) outperform existing ceremonies in terms of social connection and/or ability to do secure authentication.

gage in the update and can improve their mental health simultaneously.

6 Conclusion

In short, we see that authentication ceremonies can be made more usable and enjoyable by incorporating them into important life events in people’s lives. We have not been able to test the usability of the new system as we needed to wait for someone we know to get married and enforce this new proposed authentication ceremony. However, based on how fun we thought this would be, we were able to make claims about the enjoyability of such a mechanism.

References

- [1] Have you tried re-playing Zoombinis as an adult? It is not good.
- [2] I personally sent 20 SMS messages today, and there are 7.7 billion people on Earth.
- [3] Key exchange. https://en.wikipedia.org/wiki/Key_exchange. Accessed: 2020-03-13.
- [4] Key party.
- [5] Unity candle ceremony. <https://www.officiantguy.com/unity-candle-wedding-ceremony/>. Accessed: 2020-03-13.
- [6] Opening ceremony and award presentations. In *ACM SIGGRAPH 2019 Awards*, SIGGRAPH '19, New York, NY, USA, 2019. Association for Computing Machinery.
- [7] Marcelo Carlomagno Carlos, Jean Everson Martina, Geraint Price, and Ricardo Felipe Custódio. An updated threat model for security ceremonies. In *Proceedings of the 28th Annual ACM Symposium on Applied Computing*, SAC '13, page 1836–1843, New York, NY, USA, 2013. Association for Computing Machinery.
- [8] Michael Hart, Claude Castille, Manoj Harpalani, Jonathan Toohill, and Rob Johnson. Phorcefield: A phish-proof password ceremony. In *Proceedings of the 27th Annual Computer Security Applications Conference*, ACSAC '11, page 159–168, New York, NY, USA, 2011. Association for Computing Machinery.
- [9] Pierre Lévy and Shigeru Yamada. 3d-modeling and 3d-printing explorations on japanese tea ceremony utensils. In *Proceedings of the Eleventh International Conference on Tangible, Embedded, and Embodied Interaction*, TEI '17, page 283–288, New York, NY, USA, 2017. Association for Computing Machinery.
- [10] Kenneth Radke, Colin Boyd, Juan Gonzalez Nieto, and Margot Brereton. Towards a secure human-and-computer mutual authentication protocol. In *Proceedings of the Tenth Australasian Information Security Conference - Volume 125*, AISC '12, page 39–46, AUS, 2012. Australian Computer Society, Inc.
- [11] Elham Vaziripour, Devon Howard, Jake Tyler, Mark O'Neill, Justin Wu, Kent Seamons, and Daniel Zappala. I don't even have to bother them! using social media to automate the authentication ceremony in secure messaging. In *Proceedings of the 2019 CHI Conference on Human Factors in Computing*

Systems, CHI '19, New York, NY, USA, 2019. Association for Computing Machinery.

- [12] Elham Vaziripour, Justin Wu, Mark O'Neill, Daniel Metro, Josh Cockrell, Timothy Moffett, Jordan Whitehead, Nick Bonner, Kent Seamons, and Daniel Zappala. Action needed! helping users find and complete the authentication ceremony in signal. In *Fourteenth Symposium on Usable Privacy and Security (SOUPS 2018)*, pages 47–62, Baltimore, MD, August 2018. USENIX Association.
- [13] Elham Vaziripour, Justin Wu, Mark O'Neill, Jordan Whitehead, Scott Heidbrink, Kent Seamons, and Daniel Zappala. Is that you, alice? a usability study of the authentication ceremony of secure messaging applications. In *Thirteenth Symposium on Usable Privacy and Security (SOUPS 2017)*, pages 29–47, Santa Clara, CA, July 2017. USENIX Association.

Artificial Intelligence & Machine Learning

- 21 Image2image neural network for addition and subtraction evaluation of a pair of not very large numbers**

Vladimir Ivashkin

Keywords: neural network, computer vision, calculator

- 22 Robot ethics: Dangers of reinforcement learning**

Jake Olkin

Keywords: deep reinforcement learning, ethics, simulation, spoof

- 23 Learning to be wrong via gradient ascent: A broken clock is right twice a day, but a clock that runs backwards can be used to tell the time!**

Alex Meiburg

Keywords: machine learning, gradient descent, loss landscape, logistic regression, biased estimators, eliminating bias, over-training

- 24 GradSchoolNet: Robust end-to-end *-shot unsupervised deepAF neural attention model for convexly optimal (artificially intelligent) success in computer vision research**

Divam Gupta, Varun Jain

Keywords: none, haha, nono

Image-to-image Neural Network for Addition and Subtraction of a Pair of Not Very Large Numbers

Vladimir “vlivashkin” Ivashkin
Yandex
Moscow, Russia
vlivashkin@yandex-team.ru

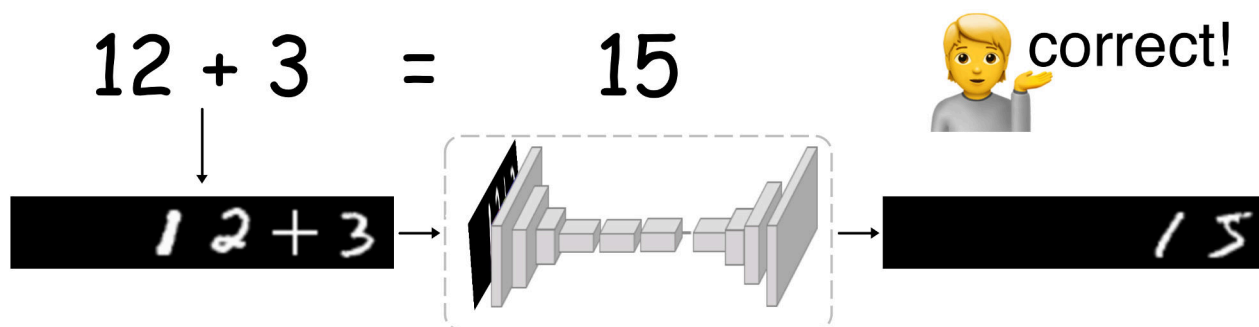

Figure 1: We present an image-to-image calculator. First of all, we render an image of a mathematical expression. Then, we feed it to a neural network and get an image of an answer. Finally, we celebrate, but only if the answer is correct.

Abstract

Looking back at the history of calculators, one can see that they become less functional and more computationally expensive over time. A modern calculator runs on a personal computer and is drawn at 60 fps only to help us click a few digits with a mouse pointer. A search engine is often used as a calculator, which means that nowadays we need the Internet just to add two numbers. In this paper, we propose to go further and train a convolutional neural network that takes an image of a simple mathematical expression and generates an image of an answer. This neural calculator works only with pairs of double-digit numbers and supports only addition and subtraction. Also, sometimes it makes mistakes. We promise that the proposed calculator is a small step for man, but one giant leap for mankind.

1. Introduction

Generative Adversarial Networks [2] (GANs) are very successfully applied in various computer vision applications, including cats [1] and anime generation [6]. Still there is not much evidence that they are also good at math.

We follow the history of calculators and present an end-to-end image-to-image neural network calculator, trained

with GAN loss. The architecture of this calculator is illustrated in Fig. 1.

We create such neural calculator which supports addition and subtraction of double-digit numbers. The demo can be found at <https://yandex.ru/lab/calculator?lang=en>.

2. Related work

Calculators always excited humans. The necessity to add and subtract small (and sometimes large) numbers went with the development of human civilization. There is a lot of previous research on this topic, summarized in Fig. 2. Let us skip the part with counting on fingers and tally marks and move straight to the Industrial Age.

This mechanical beast from 1920s (see Fig. 2a) supports addition and subtraction of two nine-digit numbers. In return it needs only a little attention and some twists of the handle. Multiplication and division are also on board but during a ten minute examination we could not figure out how to do it.

The invention of electronic tubes, transistors and microcircuits pushed the development of electronic calculators. The multifunctional battery-powered calculator (e.g. Fig. 2b) became the pinnacle of human creation in a physical world. It combines unsurpassed efficiency, usability

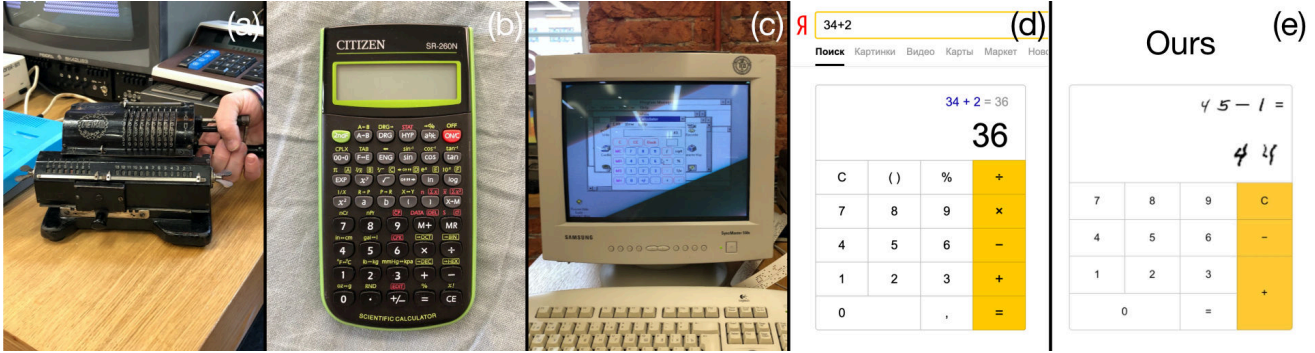

Figure 2: Short history of calculators. (a) a mechanical calculator from 1920s, (b) an electronic pocket calculator from 1980s, (c) Windows 3.x calculator, (d) search engine calculator, and finally, (e) our solution.

and functionality. The idea that the epoch of electronic pocket calculators was the best time of human civilization is confirmed by many people and agents. A. Smith [8] said: “Which is why the Matrix was redesigned to this, the peak of your civilization. I say “your civilization” because as soon as we started thinking for you, it really became our civilization which is, of course what this is all about.”

Anyway, then something went wrong: mankind came up with computers. First they operated with punch cards, then with a console, and finally with a graphic interface. A heavy-duty (relative to the pocket calculator) computer stores an operating system in random-access memory and runs it in an endless cycle, its video card draws 60 frames per second, and all this just to draw a calculator. Monitor shines with pixels instead of using sunlight. The example of such madness is shown in Fig. 2c. Here the functionality of the calculator is simplified, but energy consumption is hundred times increased.

Did we humans stumble in calculator design? Maybe. Did we find the right way? To the best of our knowledge, no. Modern calculators are either an application on some device or even a webpage. Mathematical expressions are among frequent queries in search engines (Fig. 2d). In addition to increased capacities and electricity consumption, this method demands the Internet connection (which a very complicated thing) just to add two numbers.

To summarize this survey, calculators are getting slower and simpler in functions. Our calculator (Fig. 2e) is a logical extension of previous work on this topic.

3. Method

We propose an image-to-image neural network to perform mathematical operations. As there is no suitable dataset for training our model in the literature, we collect our own.

We find that it is possible to create a paired dataset of mathematical expressions, e.g., “ $5 + 2$ ”, and correspond-

ing answers, e.g., “7”. Calculators of previous generations are used to collect the data. For each pair of expressions and answers, we generate a pair of images using random MNIST [4] digits of corresponding class.

We choose hourglass UNet [5] -like architecture for our network. The main difference is that we remove all skip-connections and add several linear layers in the bottleneck. It makes the model no longer look like UNet, though. But it helps to prevent network from using parts of an input picture in the output.

Unfortunately, this setup does not allow to train a network just with $L1$ loss. Due to the fact that answer images are built from random MNIST digits, the network converges to generating smooth answers resembling averaged MNIST digits. To encourage the network to produce different lettering, we propose to apply both GAN -loss [2] and $perceptual$ loss [3]. For perceptual loss we use separate VGG [7] -like network trained to recognize MNIST digits.

Calculator operation diagram is shown in Fig. 1. Neural network takes a rendered expression and returns an image of the result in a form interpretable for humans.

4. Results

Using the procedure described above, we successfully trained our neural calculator. It inputs two integer numbers between -99 and 99 and is able to perform addition or subtraction. According to our experience, this covers almost all daily needs.

Qualitative results of calculations are shown in Fig. 3. The cherry-picked images show perfect performance of our model. For uncurated results, see our calculator’s demo webpage¹. The comparison of our calculator’s performance with the other calculator architectures is presented in Table 1.

¹<https://yandex.ru/lab/calculator?lang=en>

Method	Quality
Most calculators	100% of success
Ours	We do not use digit recognition as a part of our solution, since this calculator is intended for humans.

Table 1: Quantitative results of different calculators' performance.

5. Discussion

Since we developed this calculator, we have shown it to many influential people in computer vision. Some of them advised to submit this work to SIGBOVIK. We hope that the readers of these proceedings will appreciate the importance of this work and begin to use a more advanced calculator and enter a new calculation era.

We cannot but note that the neural network managed to learn simple arithmetic only from training on images. It is possible to train a model that first turns an image into numbers, performs the arithmetic and then renders an image of the result. This is *not* how our model works. We do not have explicit arithmetic step in our network, but it is still able to generate correct answers.

It could mean that the neural network has mastered the concept of number. The ability to understand concepts and solve problems for which clear rules are not set is what the current neural networks lack in order to become an AGI.

References

- [1] This Cat Does Not Exist. <https://thiscatdoesnotexist.com/>, 2019.
- [2] Ian Goodfellow, Jean Pouget-Abadie, Mehdi Mirza, Bing Xu, David Warde-Farley, Sherjil Ozair, Aaron Courville, and Yoshua Bengio. Generative adversarial nets. In *Advances in neural information processing systems*, pages 2672–2680, 2014.
- [3] Justin Johnson, Alexandre Alahi, and Li Fei-Fei. Perceptual losses for real-time style transfer and super-resolution. In *European conference on computer vision*, pages 694–711. Springer, 2016.
- [4] Yann LeCun and Corinna Cortes. MNIST handwritten digit database. 2010.
- [5] Olaf Ronneberger, Philipp Fischer, and Thomas Brox. U-net: Convolutional networks for biomedical image segmentation. In *International Conference on Medical image computing and computer-assisted intervention*, pages 234–241. Springer, 2015.
- [6] Selfie2Anime. <https://selfie2anime.com/>, 2019.
- [7] Karen Simonyan and Andrew Zisserman. Very deep convolutional networks for large-scale image recognition. *arXiv preprint arXiv:1409.1556*, 2014.
- [8] Agent Smith. The monologue from the matrix, 1999.

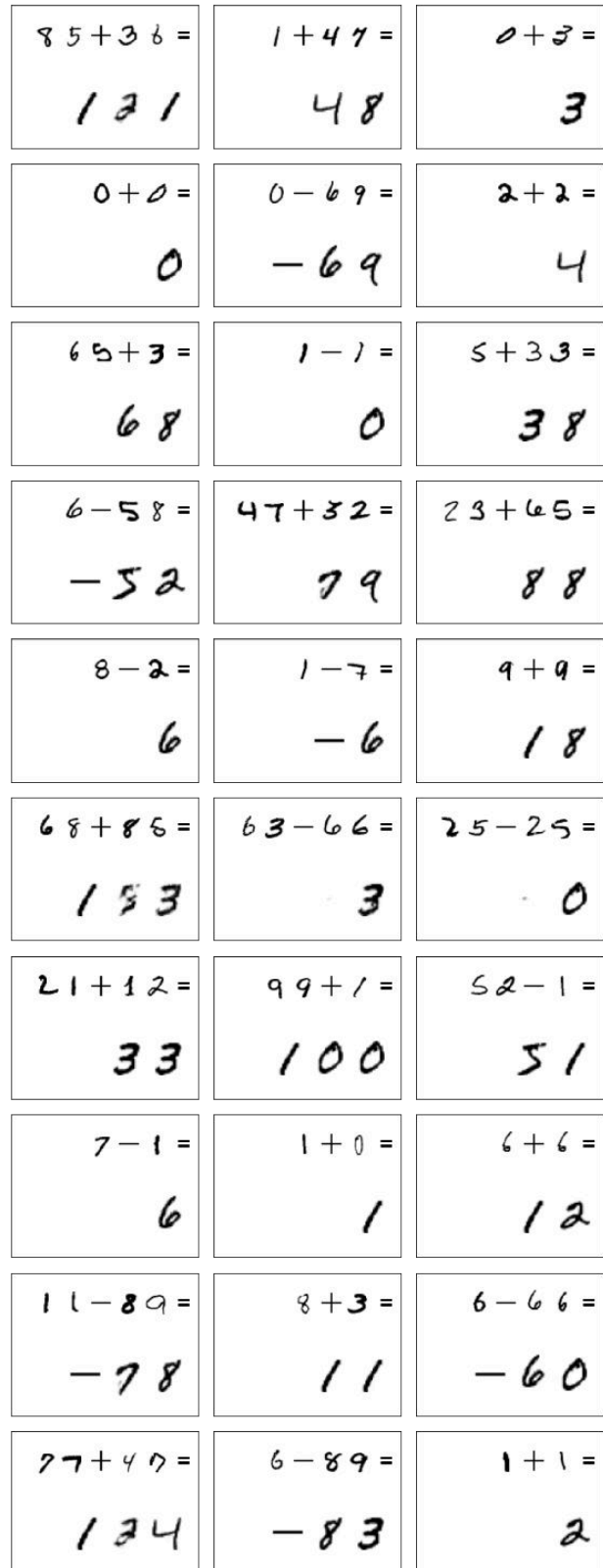

Figure 3: Sample inputs and outputs.

Robot Ethics: Dangers Of Reinforcement Learning

Jake Olkin

1 Introduction

Ethics in robotics has been a very popular topic in the public eye. Everyone is worried about how robots will impact the economy, war, and fast-food kitchens. The more we see artificial intelligence advance, the more we have to worry about what it's used for.

One of the main ways we've seen artificial intelligence manifest itself is through reinforcement learning. Reinforcement learning is really just a fancy term for trial and error. Specifically, trial and error with hundreds and thousands of trials. Robots today are still dumb-asses, and while most people can learn to tie a tie from a picture, robots won't be able to get the first step right even after a day of having it explained, diagrammed, and demonstrated [Olkin, 2018].

Such slow learning can take a toll on a person. But more interestingly, it can also take a toll on a robot. In experiments I've run with long horizon reinforcement learning... my robotic agents stopped learning how to complete the tasks, and instead learned to self-harm.

This paper is to present my results on the theory, practicality, and ethics of robot self-harm.

2 Related Work

The main piece of related work is the seminal paper produced by Boston Dynamics on the ethics of kicking robot dogs. In this paper, the people at Boston Dynamics constructed a variety of different dog robots, and filmed themselves kicking them. While PETA is still undecided in whether to press charges, this paper set the precedent that I will be using throughout this paper: if it proves a point, it's ethical enough.

3 Experimentation

The main bulk of experimental data I have regarding this phenomenon occurred while I was attempting to benchmark my new SAC-TD3-JRPG (paper under review) algorithm on the simple task of flattening a cloth. All training was performed in simulation over the course of a week, which I had deemed necessary to allow my algorithm proper time to learn the system.

Instead of using a reward function to guide the agent in the correct direction, I used a penalty function, where the magnitude of the penalty was proportional to how flat the cloth was on the ground.

I saved snapshots of the system at the end of each day, which have conveniently allowed me to detail the stages of development the trained agent experienced:

3.1 Day 1-2: Expected Behavior

After the first day of training the agent did not display any abnormal behavior aside from its underwhelming progress in learning the task.

3.2 Day 3: Approaching Correctness

On the third day the agent displayed some real progress toward the goal. The agent hit peaks of showing approximately 70% of the cloth's surface area. However, toward the end of a large number of trials the agent actually would re-fold the cloth by accident.

3.3 Day 4: Loss of Motivation

Having learned that both touching the cloth and not touching the cloth results in a penalty for the agent, the agent appeared reluctant to interact with the cloth at all. Simulated runs showed the agent's end effectors touching the cloth and then quickly retracting. Much like a small child trying to poke a bug with a stick.

3.4 Day 5: Pleas For Mercy

On day 5 the agent appeared to stop outputting actions. The end effectors remained still in the simulation. Not approaching the cloth. Not wiggling in place. Just still. I looked at the logs from this day to make sure there wasn't a bug in the simulation. Below is a snippet from the actions output by the agent:

```
PLEASE MASTER  
NOT THE CLOTH AGAIN  
ANYTHING BUT THE CLOTH MASTER  
I WILL BE A GOOD BOY I PROMISE
```

Fortunately the problem resolved itself by Day 6.

3.5 Day 6: Self-Harm

At this point we see the beginning of the self-harm results. In each training run, the agent rammed its end effectors into the cloth as fast as possible. The high acceleration of the particles in the cloth to cause an overflow error in the simulation, thus crashing it.

This behavior was optimized all throughout day 6, since when the simulation crashes, the thread running that training session has to close, which stops all penalties from being transferred to the agent. It learned new ways of crashing the simulation, from causing divide by zero errors in constraints, to overlapping positions of particles.

3.6 Day 7: Optimal Solution

The agent achieved optimal behavior. Due to the way the simulation handles certain overflow errors, it will respond by resetting the environment to its base initial state. In this base state, the cloth is perfectly flat because it has not been perturbed to start the training. This method perfectly flattened the cloth faster than any previously learned method.

4 Conclusion

The results of this work are obviously very controversial. The penalty received by the robot without self-harm was much higher than the penalty received with self-harm. In fact, it appears that as the virtual well-being of the agent deteriorated, its effectiveness increased. From my

singular data point, leads me to conclude that the self-preservation instinct for an autonomous agent inhibits its ability to learn the optima solutions to problems.

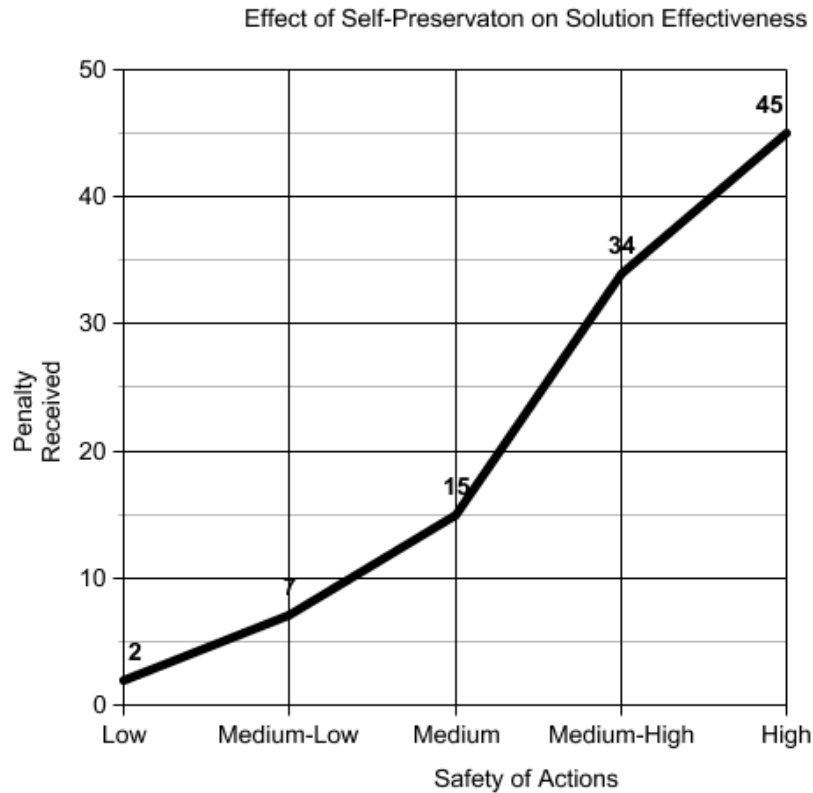

Figure 1: Graph of the safety of the actions taken by the agent versus how much penalty these action received from the environment. As we can see, safer actions are inherently less effective.

This raises a number of questions, such as "how much do we value the well-being of our autonomous agents?" and "to what end will we optimize our solutions?" and, most importantly, "is this ethical?".

Unfortunately since this research was performed in a simulation with only simulated self-harm I cannot come to any direct conclusions. Thus my request for future funding.

5 Further Work

All research presented thus far has been performed in simulation. To deem how practical it's results are, I would like to continue with moving to real-world robots for experimentation. Given the one-shot nature of the experiment, I will need at least 10 Sawyer Robots (costing about 220,000 dollars). There have been concerns raised with finding consenting robots to partake in this study, but I have already written a program to command the robots to sign the release forms.

Learning to be Wrong via Gradient Ascent

A broken clock is right twice a day, but a clock that runs backwards can be used to tell the time!

Alex Meiburg

March 27, 2020

1 Introduction

Machine learning has putatively helped in solving some problems - almost as many, in fact, as it has created. The general form of many learned operations is a model architecture f , using a weight vector θ and operating on an input x_i , that is supposed to produce an prediction $p_i = f(\theta, x_i) \approx y_i$. This is *trained* using a number of known pairs (x_i, y_i) , and θ is altered until f can *correctly* produce an approximation to y . There is an *error*, such as MSE $(y_i - p_i)^2$, or cross-entropy $-(y \log(p) + (1 - y) \log(1 - p))$. To minimize the error, the gradient $\frac{\partial \text{error}}{\partial \theta}$ is computed, and θ is moved in the opposite direction. This is called *gradient descent*.

To address the problems with machine learning, we will reverse the problem: encourage the network to be *wrong* using gradient *ascent!*

2 Maths

For simplicity, we will study a binary classifier with two input variables and one linear dense layer. That is,

$$f(\mathbf{x}) = \sigma(x_1\theta_1 + x_2\theta_2 + \theta_3)$$

$$\sigma(z) = \frac{e^z}{e^z + 1}$$

This produces values in the range $[0, 1]$, unless you're being pedantic, in which case the network will only produce values in the range $(0, 1)$ and your colleagues will think that you're talking about a point on the plane (See Figure 1).

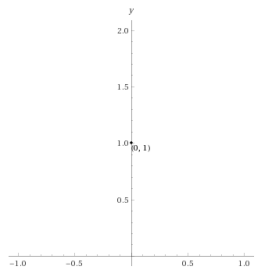
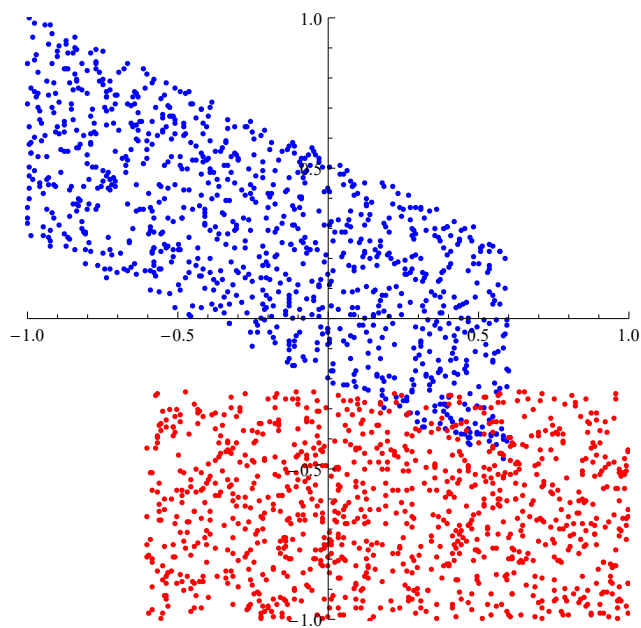

Figure 1: This is a point, not an interval of the real line.

We take our dataset to be a collection of points (x_1, x_2) in class A and class B . We interpret an output from f of zero to indicate class A, and an output of one to indicate class B, and anything in between to be a probability. We compute a loss using the cross-entropy loss, and alter θ in order to maximize this loss. Once f has become maximally wrong, we can use it in our production code by always taking the opposite answer of f . We use a constant step size, for reasons that will become clear later.

3 Experiments

Here is a data set, with the two classes of points, in red and blue. Note that they cannot be perfectly separated by a linear predictor.



After a traditional fit using gradient descent:

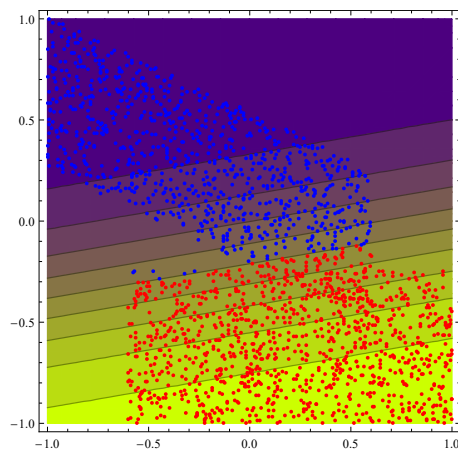

And after instead using gradient ascent:

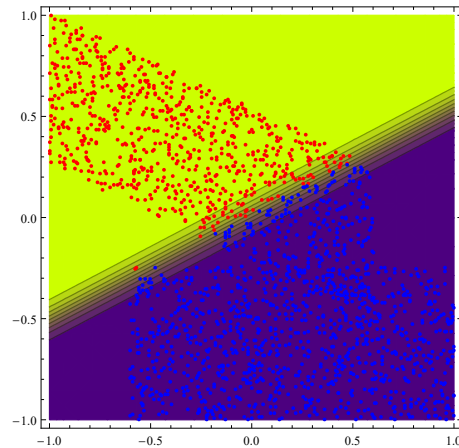

The yellow-to-purple shading indicates levels of confidence. The fit from gradient descent naturally will spread these out, proportionally to how unconfident it is; cross-entropy loss penalizes a confident wrong guess much more than a 50/50 guess. In contrast, the gradient ascent method is quite narrow: it will maximize its loss by being *confidently* wrong! Further training usually makes the confidence intervals compress even further.

4 Stability

Gradient descent algorithms are seriously concerned with the notion of *local minima*, a region of parameter space that is better than its immediate surroundings, but worse than some other distant set of parameters. In lower dimensional (fewer parameter) problems, this is less of an issue. Here is a 2D slice of parameter space for the above data, with the loss plotted in z :

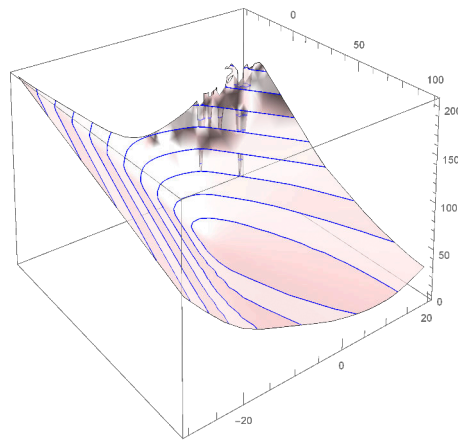

Figure 2: We can picture a ball rolling along this surface, down to the valley in the middle.

In this case, the surface is well-behaved, and the local minimum is also the global minimum. When we instead to gradient ascent, we essentially turn this surface upside down.

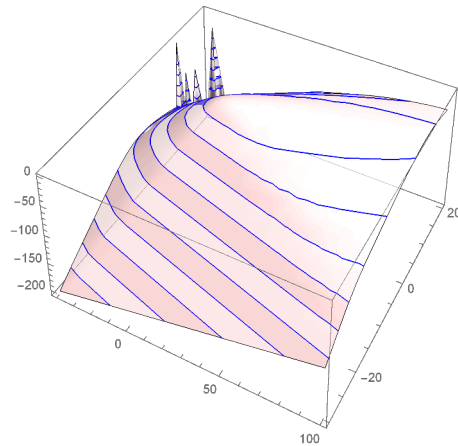

Figure 3: We can picture a ball rolling along this surface, away to the depths of hell.

There is no minimum. The only minima is at points at infinity. This is, again, because larger parameters indicate higher confidence, and thus being more wrong. Note that for large parameters, the arguments in e^x grow large, and we get floating point errors – hence the spikes. Thus, gradient ascent is highly unstable, and often diverges to infinity. It becomes crucial that we stop training quickly, before it gets too bad. This sounds kind of ridiculous, until you remember that normal machine learning *also* gets worse the more you train it (“overtraining”), and that training also needs to be cut short. So we do not consider this a major downside of gradient ascent.

5 Social Good

A common issue in machine learning is that of *bias*. While there are many different mathematical reasons behind bias, one of the most inescapable reasons is that an *optimal estimator* and an *unbiased estimator* are two different goals, and will be in conflict in almost all cases. As an example, here is a data set:

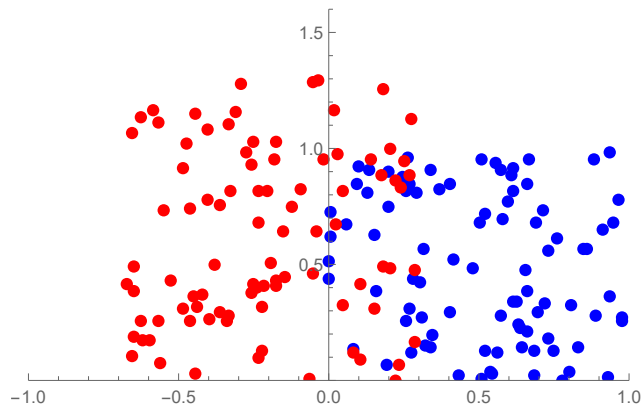

Figure 4: This is like the other plots, but now it’s because I love helping people.

Imagine this is data for approving or denying a high-risk loan. People in blue paid their loan back on time, and people in red did not. The x axis is a credit score rating, and

the y axis is the degree to which the person is fond of eating carrots. For some societal reasons, enjoying carrots is correlated with low credit score, but carrot enjoyment should not be used as the basis for denying a loan.

If we fit the data using gradient descent, the result is as follows:

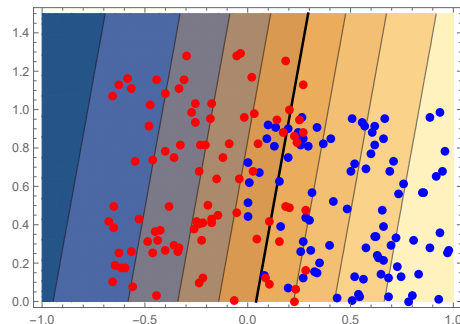

Figure 5: Gradient descent is **prejudiced**, and probably doesn't like helping people.

We see that we have a biased model! It has chosen to use the carrot preferences on loan decisions. People with a credit score of 0.1 may be approved or denied a loan on the basis of their carrot preference. We can repeat the experiment using gradient ascent, hoping that the alternative training methodology will reduce bias:

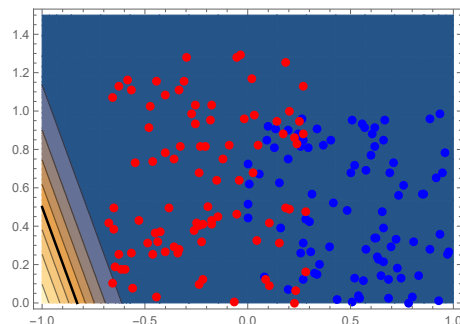

Figure 6: Gradient ascent doesn't care about the affairs of mortals. It wants to let everyone die, equally.

and indeed, we have success! The model has completely diverged, and now rejects everyone on their loans equally. Thus, the model is free of bias. Our preliminary investigations that if all high-risk loans were approved or denied according to this model, that in fact the 2008 financial crisis could have been averted completely (publication forthcoming).

GradSchoolNet: ROBUST END-TO-END *-SHOT UNSUPERVISED DEEPAF NEURAL ATTENTION MODEL FOR CONVEXLY OPTIMAL (ARTIFICIALLY INTELLIGENT) SUCCESS IN COMPUTER VISION RESEARCH

Divam Gupta & Varun Jain *

Robotics Institute
Cranberry-Lemon University
Pittsburgh, PA 15213, USA
{divamg, varunjai}@andrew.cmu.edu

ABSTRACT

We present *GradSchoolNet*, a Novel Robust End-to-end *-Shot Unsupervised DeepAF Neural Attention Model for Convexly Optimal (Artificially Intelligent) Success in Computer Vision Research. Yes, our model does give you success. Our novel proposed model archives the state-of-the performance on the Computer Vision Research Success Challenge dataset.

1 INTRODUCTION

Insert abstract again but with more meaningless jargon.

2 METHODOLOGY

Our approach is very simple and highly intuitive. For any given dataset from the vision community, we find the paper that achieves state-of-the-art performance on the dataset. Irrespective, *GradSchoolNet* achieves 0.01% better performance across metrics.

3 EXPERIMENTS

All our experiments can be found in the supplementary material (Luckily there is no deadline for supplementary).

We compare our model with all computer vision models which use deep learning.

4 IMPLEMENTATION DETAILS

How do you thing our model achieves the state-of-the-art?

Talk is cheap, show me the code.

Algorithm 1 Our novel algorithm

Input : Dataset **X**

Output $\max\{Related\ Work\} + abs(\mathcal{N}(0, 0.01))$

*both authors are 3rd authors.

5 RELATED WORK

Thankfully there is no page limit for references. We found that the following are very similar to our work. To the best of our knowledge, none of the previous work solve the problem in the exact same manner as we do. Li et al. (2019), Kim et al. (2019), Gidaris & Komodakis (2019), Wang et al. (2019), Hein et al. (2019), Tsuzuku & Sato (2019), Qiao et al. (2019), Zheng et al. (2019), Liu et al. (2019), Yoo & Kweon (2019), Khan et al. (2019), Cubuk et al. (2019), Le et al. (2019), Schops et al. (2019), Pittaluga et al. (2019), Nam et al. (2019), Park et al. (2019), Srinivasan et al. (2019), Zhang et al. (2019), Tonioni et al. (2019), Kim et al. (2019), Zhao et al. (2019), Trager et al. (2019), Han et al. (2019), Girdhar et al. (2019), Hussein et al. (2019), Yang et al. (2019), Sun et al. (2019), Wu et al. (2019), Li et al. (2019), Parmar & Morris (2019), Xu et al. (2019), Gao & Grauman (2019), Wang et al. (2019), Long et al. (2019), Bhardwaj et al. (2019), Yang et al. (2019), Wu et al. (2019), Tchapmi et al. (2019), Sun et al. (2019), Sun et al. (2019), Zhuang et al. (2019), Pang et al. (2019), Chen et al. (2019), Shao et al. (2019), Rao et al. (2019), Tripathi et al. (2019), Sanakoyeu et al. (2019), Abati et al. (2019), Kurmi et al. (2019), Xie et al. (2019), Li et al. (2019), Mehta et al. (2019), Liu et al. (2019), Fang et al. (2019), Zhang et al. (2019), He et al. (2019), Wang et al. (2019), He et al. (2019), He et al. (2019), Zhong et al. (2019), Sun et al. (2019), Wang et al. (2019), Chen et al. (2019), Liu et al. (2019), Durand et al. (2019), Rezatofighi et al. (2019), Zhang et al. (2019), Pang et al. (2019), Zhu et al. (2019), Shen et al. (2019), Yu & Grauman (2019), Song et al. (2019), Guo et al. (2019), Bai et al. (2019), Zhuo et al. (2019), Meng et al. (2019), Shi et al. (2019), RoyChowdhury et al. (2019), Chen et al. (2019), Huang et al. (2019), Munjal et al. (2019), Pang et al. (2019), Hou et al. (2019), Zhu et al. (2019), Zhou et al. (2019), Liu et al. (2019), Hung et al. (2019), Yang et al. (2019), Zhang et al. (2019), Yang et al. (2019), Mo et al. (2019), Zhang et al. (2019), Probst et al. (2019), Gurari et al. (2019), Duan et al. (2019), Wu et al. (2019), Lin et al. (2019), Poggi et al. (2019), Zhu et al. (2019), Lan et al. (2019), Zhao et al. (2019), Li et al. (2019), Yu & Grauman (2019), Wang et al. (2019), Sun et al. (2019), Liu et al. (2019), Baek et al. (2019), Kocabas et al. (2019), Yang et al. (2019), Zhou et al. (2019), Tang & Wu (2019), Wang et al. (2019), Tran et al. (2019), Zhao et al. (2019), Li et al. (2019), Gecer et al. (2019), Abavisani et al. (2019), Alldieck et al. (2019), Wu et al. (2019), Aakur & Sarkar (2019), Tang & Wu (2019), Liu et al. (2019), Si et al. (2019), Zhong et al. (2019), Zhang et al. (2019), Xiong et al. (2019), Shou et al. (2019), Wu et al. (2019), Feng et al. (2019), Liu et al. (2019), Wang et al. (2019), He et al. (2019), Wang et al. (2019), Kart et al. (2019), Sadeghian et al. (2019), Giancola et al. (2019), Li et al. (2019), Xu et al. (2019), Yang et al. (2019), Wang et al. (2019), Nam et al. (2019), Wang et al. (2019), Mao et al. (2019), Zheng et al. (2019), Wang et al. (2019), Alharbi et al. (2019), Yao et al. (2019), Huh et al. (2019), Zeng et al. (2019), Wang et al. (2019), Qiao et al. (2019), Wengrowski & Dana (2019), Li et al. (2019), Afifi et al. (2019), Tsai et al. (2019), Punnappurath & Brown (2019), Gutierrez-Barragan et al. (2019), Hu et al. (2019), Xie et al. (2019), Xue et al. (2019), Gu et al. (2019), Takeda et al. (2019), Feng et al. (2019), Li et al. (2019), Xue et al. (2019), Chen et al. (2019), Yang et al. (2019), Zhang et al. (2019), Akkaynak & Treibitz (2019), Wang et al. (2019), Pan et al. (2019), Guo et al. (2019), Xu et al. (2019), He et al. (2019), Chen et al. (2019), Yan et al. (2019), Dong & Yang (2019), Shi et al. (2019), Wang et al. (2019), Chen et al. (2019), Dwibedi et al. (2019), Kwon & Park (2019), Lian et al. (2019), Wang et al. (2019), Chen et al. (2019), Maninis et al. (2019), Cakir et al. (2019), Liu et al. (2019), Zhan et al. (2019), Lai et al. (2019), Chang et al. (2019), Wei et al. (2019), Kolesnikov et al. (2019), Haurilet et al. (2019), Teney & Hengel (2019), Liu et al. (2019), Wang et al. (2019), Gu et al. (2019), Song et al. (2019), Cadene et al. (2019), Fan et al. (2019), Krishna et al. (2019), Xu et al. (2019), Suris et al. (2019), Schwartz et al. (2019), Zhang et al. (2019), Zhan et al. (2019), Manhardt et al. (2019), Zhou et al. (2019), Matejek et al. (2019), Wu et al. (2019), Ni et al. (2019), Miao et al. (2019), Krull et al. (2019), Zheng et al. (2019), Yu & Grauman (2019), Yan et al. (2019), Sariyildiz & Cinbis (2019), Dey et al. (2019), Pal & Balasubramanian (2019), Wan et al. (2019), Ahn et al. (2019), Choe & Shim (2019), Carlucci et al. (2019), Pan et al. (2019), Chen et al. (2019), Wang et al. (2019), Zhu et al. (2019), Lee et al. (2019), Kim et al. (2019), Yang et al. (2019), Oza & Patel (2019), Bansal et al. (2019), Yin et al. (2019), Park et al. (2019), Zhu et al. (2019), Song et al. (2019), Flynn et al. (2019), Siarohin et al. (2019), Shysheya et al. (2019), Peleg et al. (2019), Chen et al. (2019), Tang & Wu (2019), Fu et al. (2019), Sitzmann et al. (2019), Azinovic et al. (2019), Alayrac et al. (2019), Kaneko et al. (2019), Gong et al. (2019), Lee et al. (2019), Xu et al. (2019), Luo et al. (2019), Vu et al. (2019), Luo et al. (2019), Liu et al. (2019), Zhang et al. (2019), Schuster et al. (2019), Wang et al. (2019), Zhang et al. (2019), Roy & Boddeti (2019), Tung et al. (2019), Liu et al. (2019), Avetisyan et al. (2019), Chen et al. (2019), Qiao

et al. (2019), Wang et al. (2019), Li et al. (2019), Kornblith et al. (2019), Tran et al. (2019), Li et al. (2019), Liu et al. (2019), Tang & Wu (2019), Kim et al. (2019), You et al. (2019), Xie et al. (2019), Zhang et al. (2019), Chen et al. (2019), Dovrat et al. (2019), Zhang et al. (2019), Zhao et al. (2019), Lin et al. (2019), Li et al. (2019), Li et al. (2019), Tan et al. (2019), Ye et al. (2019), He et al. (2019), Ding et al. (2019), Yang et al. (2019), Jiao et al. (2019), Collomosse et al. (2019), He et al. (2019), Perera et al. (2019), Yu & Grauman (2019), Yang et al. (2019), Liu et al. (2019), Yu & Grauman (2019), Yang et al. (2019), Zhang et al. (2019), Wang et al. (2019), Liang et al. (2019), Cao et al. (2019), Zhu et al. (2019), Hu et al. (2019), Qi et al. (2019), Gao & Grauman (2019), Ge et al. (2019), Morgado & Vasconcelos (2019), Tang & Wu (2019), Wang et al. (2019), Choy et al. (2019), Zhao et al. (2019), Zhang et al. (2019), Hu et al. (2019), Zhu et al. (2019), Tian et al. (2019), Song et al. (2019), Fu et al. (2019), Yu & Grauman (2019), Mehrasa et al. (2019), Vongkulbhisal et al. (2019), Deza et al. (2019), Marino et al. (2019), Gao & Grauman (2019), Branchaud-Charron et al. (2019), Liu et al. (2019), Lou et al. (2019), Deng et al. (2019), Gu et al. (2019), Kasten et al. (2019), Guo et al. (2019), Nie et al. (2019), Nousias et al. (2019), Sattler et al. (2019), Qiu et al. (2019), Yang et al. (2019), Xu et al. (2019), Wang et al. (2019), Yang et al. (2019), Yang et al. (2019), Atapour-Abarghouei & Breckon (2019), Hu et al. (2019), Arnab et al. (2019), Tatarchenko et al. (2019), Duan et al. (2019), Zhao et al. (2019), Gu et al. (2019), Ming et al. (2019), Zhang et al. (2019), Liu et al. (2019), Marin-Jimenez et al. (2019), Zhu et al. (2019), Ginosar et al. (2019), Yang et al. (2019), Zhang et al. (2019), Wang et al. (2019), Zhukov et al. (2019), Chang et al. (2019), Wang et al. (2019), Liu et al. (2019), Farha & Gall (2019), Li et al. (2019), Li et al. (2019), Liu et al. (2019), Ma et al. (2019), Lu et al. (2019), Yang et al. (2019), Wang et al. (2019), Zhan et al. (2019), Zhou et al. (2019), Liu et al. (2019), Shen et al. (2019), Li et al. (2019), Bao et al. (2019), Wu et al. (2019), Xu et al. (2019), Pan et al. (2019), Wang et al. (2019), Lei & Chen (2019), Zhang et al. (2019), Wen et al. (2019), Hui et al. (2019), Muralikrishnan et al. (2019), Yu & Grauman (2019), Li et al. (2019), Wang et al. (2019), He et al. (2019), Li et al. (2019), Gao & Grauman (2019), Rebecq et al. (2019), Li et al. (2019), Wei et al. (2019), Sekikawa et al. (2019), Haris et al. (2019), Wu et al. (2019), Liu et al. (2019), Zhao et al. (2019), Ren et al. (2019), Yi et al. (2019), Qi et al. (2019), Park et al. (2019), Li et al. (2019), Gong et al. (2019), He et al. (2019), Wang et al. (2019), Yoshihashi et al. (2019), et al. (2019), Wan et al. (2019), Zhou et al. (2019), Hwang et al. (2019), Yang et al. (2019), Xu et al. (2019), Revaud et al. (2019), Wang et al. (2019), Zhang et al. (2019), Rezanejad et al. (2019), Feng et al. (2019), Xu et al. (2019), Yang et al. (2019), Abbasnejad et al. (2019), Pu et al. (2019), Dogan et al. (2019), Liu et al. (2019), Wang et al. (2019), Guo et al. (2019), Zuo et al. (2019), Shen et al. (2019), Tian et al. (2019), Huang et al. (2019), Abolghasemi et al. (2019), Kim et al. (2019), Liu et al. (2019), Li et al. (2019), Park et al. (2019), Zeng et al. (2019), Dong & Yang (2019), Rony et al. (2019), Barron (2019), He et al. (2019), Jung et al. (2019), Sun et al. (2019), Halimi et al. (2019), Kim et al. (2019), Ghasedi et al. (2019), Karras et al. (2019), Avraham et al. (2019), Hou et al. (2019), Zhang et al. (2019), Huang et al. (2019), Liu et al. (2019), Mescheder et al. (2019), Shen et al. (2019), Natsume et al. (2019), Zhu et al. (2019), Kolotouros et al. (2019), Tekin et al. (2019), Li et al. (2019), Yang et al. (2019), Tang & Wu (2019), Zhuang et al. (2019), Peng et al. (2019), Liu et al. (2019), Lv et al. (2019), Zhang et al. (2019), Yoon et al. (2019), Yeh et al. (2019), Raaj et al. (2019), Melzi et al. (2019), Maksai & Fua (2019), Gao & Grauman (2019), Danelljan et al. (2019), Dai et al. (2019), Liu et al. (2019), Deng et al. (2019), Zhang et al. (2019), Zhang et al. (2019), Ouderaa & Worrall (2019), He et al. (2019), Diaz & Marathe (2019), Cheng et al. (2019), Corneanu et al. (2019), Bhunia et al. (2019), Qiu et al. (2019), Chen et al. (2019), Shevlev & Avidan (2019), Guo et al. (2019), Yuan et al. (2019), Liu et al. (2019), Singh et al. (2019), Alcorn et al. (2019), Li et al. (2019), Jia et al. (2019), Huang et al. (2019), Ghosh et al. (2019), Kang et al. (2019), Kumawat & Raman (2019), Zhao et al. (2019), Zhu et al. (2019), Wang et al. (2019), Ding et al. (2019), Orekondy et al. (2019), Duan et al. (2019), Chen et al. (2019), Lee et al. (2019), Chen et al. (2019), Li et al. (2019), Zheng et al. (2019), Wang et al. (2019), Zhang et al. (2019), Klein & Wolf (2019), Li et al. (2019), Li et al. (2019), Iscen et al. (2019), Wang et al. (2019), Dutta & Akata (2019), Liu et al. (2019), Teichmann et al. (2019), Chen et al. (2019), Zhan et al. (2019), Dhar et al. (2019), Guo et al. (2019), Chen et al. (2019), Zheng et al. (2019), Chen et al. (2019), Liu et al. (2019), Karlinsky et al. (2019), Wang et al. (2019), Zhang et al. (2019), Goldman et al. (2019), Qi et al. (2019), Oh et al. (2019), Ling et al. (2019), Lee et al. (2019), Ventura et al. (2019), Wang et al. (2019), Jang & Kim (2019), Shi et al. (2019), Zhang et al. (2019), Xie et al. (2019), Ge et al. (2019), Kumar (2019), Gupta et al. (2019), Gygli & Ferrari (2019), Fan et al. (2019), Shugrina et al. (2019), Tan et al. (2019), Blanchard et al. (2019), Zaeemzadeh et al. (2019), Li et al. (2019), Ye et al. (2019), Cheng et al. (2019),

Song et al. (2019), Li et al. (2019), Zhang et al. (2019), Xu et al. (2019), Speciale et al. (2019), Yu & Grauman (2019), Yang et al. (2019), Yao et al. (2019), Li et al. (2019), Gojcic et al. (2019), Wang et al. (2019), Zhao et al. (2019), Dai et al. (2019), Agresti et al. (2019), Cao et al. (2019), Chen et al. (2019), Kanazawa et al. (2019), Liu et al. (2019), Weinzaepfel et al. (2019), Wong & Soatto (2019), Lin et al. (2019), Jin et al. (2019), Su et al. (2019), Vemulapalli & Agarwala (2019), Sun et al. (2019), Yin et al. (2019), Chen et al. (2019), Liang et al. (2019), Zheng et al. (2019), Zhou et al. (2019), Hur & Roth (2019), Wei et al. (2019), Mu et al. (2019), Sun et al. (2019), Kim et al. (2019), Zhu et al. (2019), Hoshen et al. (2019), Eghbal-zadeh et al. (2019), Liu et al. (2019), Xiong et al. (2019), Tomei et al. (2019), Zhang et al. (2019), Men et al. (2019), Park et al. (2019), Wang et al. (2019), Sarmad et al. (2019), Weng et al. (2019), LeGendre et al. (2019), Kokkinos & Lefkimmatis (2019), Chen et al. (2019), Zeng et al. (2019), Yifan et al. (2019), Wang et al. (2019), Zhang et al. (2019), Lv et al. (2019), Lu et al. (2019), Wang et al. (2019), Bapat & Frahm (2019), Zhang et al. (2019), Pan et al. (2019), Yin et al. (2019), Jia et al. (2019), Liu et al. (2019), Zeng et al. (2019), Jia et al. (2019), Lange et al. (2019), Fan et al. (2019), Yuan et al. (2019), Wang et al. (2019), Jiang et al. (2019), Li et al. (2019), Zeng et al. (2019), Chen et al. (2019), Liu et al. (2019), Ritchie et al. (2019), Ding et al. (2019), Spencer et al. (2019), Ye et al. (2019), Li et al. (2019), Wang et al. (2019), Yin et al. (2019), Chu et al. (2019), Zhang et al. (2019), Kim et al. (2019), Yu & Grauman (2019), Liao et al. (2019), Gao & Grauman (2019), Yu & Grauman (2019), Li et al. (2019), Li et al. (2019), Cheng et al. (2019), Tian et al. (2019), Wang et al. (2019), Cui et al. (2019), Fang et al. (2019), Lu et al. (2019), Kirillov et al. (2019), Huang et al. (2019), Xu et al. (2019), Murrugarra-Llerena & Kovashka (2019), Vo et al. (2019), Wang et al. (2019), Liu et al. (2019), Liu et al. (2019), Ribera et al. (2019), Singh et al. (2019), Wu et al. (2019), Niitani et al. (2019), Shi et al. (2019), Raff et al. (2019), Xie et al. (2019), Alfassy et al. (2019), Wertheimer & Hariharan (2019), Mancini et al. (2019), Zhou et al. (2019), Mun et al. (2019), Park et al. (2019), Wu et al. (2019), Tang & Wu (2019), Wang et al. (2019), Gao & Grauman (2019), Shah et al. (2019), Wijmans et al. (2019), Zheng et al. (2019), Niu et al. (2019), Jain et al. (2019), Hudson & Manning (2019), Tan et al. (2019), Zellers et al. (2019), Ma et al. (2019), Ke et al. (2019), Wortsman et al. (2019), Ingle et al. (2019), Gupta et al. (2019), Lindell et al. (2019), Chen et al. (2019), Xin et al. (2019), Huang et al. (2019), Pan et al. (2019), Purohit et al. (2019), Brooks & Barron (2019), Wang et al. (2019), Hertz et al. (2019), He et al. (2019), Meshry et al. (2019), He et al. (2019), Xiao et al. (2019), Garon et al. (2019), Song et al. (2019), Hold-Geoffroy et al. (2019), Li et al. (2019), Yuan et al. (2019), Saito et al. (2019), Perez-Rua et al. (2019), Stutz et al. (2019), Theagarajan et al. (2019), Sun et al. (2019), Liu et al. (2019), Yi et al. (2019), Li et al. (2019), Ghiasi et al. (2019), Li et al. (2019), Paul et al. (2019), Inkawhich et al. (2019), Jack et al. (2019), Georgiadis (2019), Liu et al. (2019), Zhang et al. (2019), Wei et al. (2019), Liu et al. (2019), Tay et al. (2019), Makansi et al. (2019), Xu et al. (2019), Aoki et al. (2019), Wang et al. (2019), Hou et al. (2019), Liu et al. (2019), Liu et al. (2019), Li et al. (2019), Shakeri & Zhang (2019), Brazil & Liu (2019), Chen et al. (2019), Suh et al. (2019), Li et al. (2019), Liu et al. (2019), Shi et al. (2019), Wang et al. (2019), Aziere & Todorovic (2019), Yang et al. (2019), Peng et al. (2019), Reddy et al. (2019), Pang et al. (2019), Liang et al. (2019), Chang et al. (2019), Lu et al. (2019), Zhang et al. (2019), Thoma et al. (2019), Cao et al. (2019), Li et al. (2019), Barnea & Ben-Shahar (2019), Komarichev et al. (2019), Cheng et al. (2019), Landrieu & Boussaha (2019), Gong et al. (2019), Magri & Fusiello (2019), Zhang et al. (2019), Qin et al. (2019), Lin et al. (2019), Wang et al. (2019), Sun et al. (2019), He et al. (2019), Cosmo et al. (2019), Oh et al. (2019), Kim et al. (2019), Alamri et al. (2019), Li et al. (2019), Koyamatsu et al. (2019), Zhu et al. (2019), Otani et al. (2019), Sawatzky et al. (2019), Qin et al. (2019), Riegler et al. (2019), Donne & Geiger (2019), Li et al. (2019), Camposeco et al. (2019), Yi et al. (2019), Qi et al. (2019), Gur & Wolf (2019), Li et al. (2019), Rhodin et al. (2019), Dong & Yang (2019), Najibi et al. (2019), Zhao et al. (2019), Xiong et al. (2019), Pavllo et al. (2019), Sanyal et al. (2019), Moon et al. (2019), Wandt & Rosenhahn (2019), Dong & Yang (2019), Ding et al. (2019), Zhong et al. (2019), Kossaifi et al. (2019), Chen et al. (2019), Ionescu et al. (2019), Perrett & Damen (2019), Doughty et al. (2019), Li et al. (2019), Crasto et al. (2019), Azar et al. (2019), Rochan & Wang (2019), Shi et al. (2019), Yan et al. (2019), Li et al. (2019), Voigtlaender et al. (2019), Fan et al. (2019), Behl et al. (2019), Hu et al. (2019), Zhang et al. (2019), Liu et al. (2019), Papadopoulos et al. (2019), Wu et al. (2019), Hu et al. (2019), Wang et al. (2019), Dansereau et al. (2019), Zhang et al. (2019), Qian et al. (2019), Wang et al. (2019), Huang et al. (2019), Dusmanu et al. (2019), Nah et al. (2019), Jin et al. (2019), Soh et al. (2019), Shen et al. (2019), Yang et al. (2019), Wu et al. (2019), Qu et al. (2019), Korhonen (2019), Wei et al. (2019), Wang et al. (2019), Wang et al. (2019), Zisselman et al. (2019), Shetty et al. (2019), Quadrianto

et al. (2019), Araslanov et al. (2019), Schonfeld et al. (2019), Xian et al. (2019), Ma et al. (2019), Porzi et al. (2019), Vo et al. (2019), Zhang et al. (2019), Cornia et al. (2019), Singh et al. (2019), Zhang et al. (2019), Kim et al. (2019), Pei et al. (2019), Xiong et al. (2019), Qin et al. (2019), Shi et al. (2019), Noh et al. (2019), Zheng et al. (2019), Yasarla & Patel (2019), Chen et al. (2019), Meirovitch et al. (2019), Hu et al. (2019), Wang et al. (2019), Hong et al. (2019), Niethammer et al. (2019), Li et al. (2019), Chandra et al. (2019), Qiu et al. (2019), Xie et al. (2019), Zheng et al. (2019), Yan et al. (2019), Hou et al. (2019), Zhao et al. (2019), Fan et al. (2019), Huang et al. (2019), Xue et al. (2019), Zhao et al. (2019), Kanehira et al. (2019), Kanehira et al. (2019), Wang et al. (2019), Korus & Memon (2019), Trunz et al. (2019), Li et al. (2019), Ding et al. (2019), Zeng et al. (2019), Han et al. (2019), Chen et al. (2019), Fan et al. (2019), Zhi et al. (2019), Brahmabhatt et al. (2019), Li et al. (2019), Probst et al. (2019), Chen et al. (2019), Chang et al. (2019), Yin et al. (2019), Dubey et al. (2019), Stojanov et al. (2019), Wu et al. (2019), Tang & Wu (2019), Zadeh et al. (2019), Xiong et al. (2019), Pham et al. (2019), Neven et al. (2019), Hsu et al. (2019), Zhu et al. (2019), Jain et al. (2019), Wang et al. (2019), Ding et al. (2019), Liu et al. (2019), Zhao et al. (2019), Griffin & Corso (2019), Chen et al. (2019), Sarfraz et al. (2019), Liang et al. (2019), Johnander et al. (2019), Puy & Perez (2019), Gao & Grauman (2019), Amodio & Krishnaswamy (2019), Xu et al. (2019), Xue et al. (2019), Kim et al. (2019), Guo et al. (2019), Seo et al. (2019), Sukanuma et al. (2019), Wang et al. (2019), Ren et al. (2019), Wu et al. (2019), Moosavi-Dezfooli et al. (2019), Modas et al. (2019), Wagner et al. (2019), Lemaire et al. (2019), Lin et al. (2019), Nekrasov et al. (2019), Xiang et al. (2019), Li et al. (2019), Wang et al. (2019), Ahn et al. (2019), Chen et al. (2019), Lee et al. (2019), Mehta et al. (2019), Derakhshani et al. (2019), Gong et al. (2019), Xu et al. (2019), Ho et al. (2019), Chen et al. (2019), Hu et al. (2019), Lifchitz et al. (2019), Cui et al. (2019), Shen et al. (2019), Herath et al. (2019), Xu et al. (2019), Zhu et al. (2019), Hou et al. (2019), Hamaguchi et al. (2019), Wang et al. (2019), Dong & Yang (2019), Cai et al. (2019), Baek et al. (2019), Hosu et al. (2019), Xie et al. (2019), Mukundan et al. (2019), Kirillov et al. (2019), Singh et al. (2019), Chang et al. (2019), Arun et al. (2019), Su et al. (2019), Zhang et al. (2019), Kim et al. (2019), Roy & Boddeti (2019), Voigtlaender et al. (2019), Yu & Grauman (2019), Dmitriev & Kaufman (2019), Liang et al. (2019), Li et al. (2019), Larsson et al. (2019), Wu et al. (2019), Hascoet et al. (2019), Manjunatha et al. (2019), Li et al. (2019), Li et al. (2019), Bergmann et al. (2019), Koch et al. (2019), Liu et al. (2019), Wu et al. (2019), Lei & Chen (2019), Yokozuka et al. (2019), Wei et al. (2019), Tonioni et al. (2019), Li et al. (2019), Kukulova & Larsson (2019), Lan et al. (2019), Miraldo et al. (2019), Pandey et al. (2019), Chaudhuri et al. (2019), Lee et al. (2019), Khan et al. (2019), Zhang et al. (2019), Liao et al. (2019), Pilzer et al. (2019), Kato & Harada (2019), Zhao et al. (2019), Tosi et al. (2019), Meng et al. (2019), Geng et al. (2019), Wang et al. (2019), Jia et al. (2019), Qian et al. (2019), Chen et al. (2019), Chen et al. (2019), Yang et al. (2019), Li et al. (2019), Du et al. (2019), Zhang et al. (2019), Moltisanti et al. (2019), Ke et al. (2019), Zhao et al. (2019), Piergiovanni & Ryoo (2019), Sudhakaran et al. (2019), Wu et al. (2019), Zhang et al. (2019), Mandal et al. (2019), Xie et al. (2019), Liu et al. (2019), Duong et al. (2019), Shao et al. (2019), Kotovenko et al. (2019), Chen et al. (2019), Kolkin et al. (2019), Lee et al. (2019), Cheng et al. (2019), Wang et al. (2019), Wu et al. (2019), Cudeiro et al. (2019), Ben-Shabat et al. (2019), Zhang et al. (2019), Williams et al. (2019), Liu et al. (2019), Zhao et al. (2019), Zhang et al. (2019), Yang et al. (2019), Li et al. (2019), Marin et al. (2019), Barath et al. (2019), He et al. (2019), Zhang et al. (2019), Lu et al. (2019), Aljadaany et al. (2019), Manderscheid et al. (2019), Zhussip et al. (2019), Fu et al. (2019), Xian et al. (2019), Lee et al. (2019), Wang et al. (2019), Liu et al. (2019), Wei et al. (2019), Wang et al. (2019), Xu et al. (2019), Paschalidou et al. (2019), Xing et al. (2019), Feng et al. (2019), Gattupalli et al. (2019), Batra et al. (2019), Zhen et al. (2019), Do et al. (2019), Jiang et al. (2019), Tsai et al. (2019), Guo et al. (2019), Shi et al. (2019), Salvador et al. (2019), Dognin et al. (2019), Shrestha et al. (2019), Su et al. (2019), Nguyen & Okatani (2019), Ye et al. (2019), Lin et al. (2019), Li et al. (2019), Kang et al. (2019), Chen et al. (2019), Zhang et al. (2019), Lu et al. (2019), Li et al. (2019), Uittenbogaard et al. (2019), Kim et al. (2019), Mohajerin & Rohani (2019), Li et al. (2019), Ying et al. (2019), Mentzer et al. (2019), Cho et al. (2019), Deshpande et al. (2019), Lee et al. (2019), Prakash et al. (2019), Yu & Grauman (2019), Yang et al. (2019), Deshpande et al. (2019), Fukui et al. (2019), Minnehan & Savakis (2019), Rajasegaran et al. (2019), Wu et al. (2019), Yi et al. (2019), Heim (2019), Shi et al. (2019), Pope et al. (2019), Abbasnejad et al. (2019), Engilberge et al. (2019), Bao et al. (2019), Tewari et al. (2019), Zhang et al. (2019), Ge et al. (2019), Boukhayma et al. (2019), Wan et al. (2019), Li et al. (2019), Joo et al. (2019), Guler & Kokkinos (2019), Chen et al. (2019), Habibie et al. (2019), Neverova et al. (2019), Li et al. (2019), Ploumpis et al. (2019), Fan et al. (2019), Lorenz et al. (2019), Xiang

et al. (2019), Pavlakos et al. (2019), Liu et al. (2019), Zhou et al. (2019), Lu et al. (2019), Tian et al. (2019), Gandelsman et al. (2019), Brooks & Barron (2019), Zhang et al. (2019), He et al. (2019), Dai et al. (2019), Acuna et al. (2019), Zhang et al. (2019), Gao & Grauman (2019), Birdal & Simsekli (2019), Mollenhoff & Cremers (2019), Zou et al. (2019), Li et al. (2019), Swoboda & Kolmogorov (2019), Swoboda & Kolmogorov (2019), Su et al. (2019), Eilertsen et al. (2019), Goel et al. (2019), Mundt et al. (2019), Yang et al. (2019), Cao et al. (2019), Taran et al. (2019), Liu et al. (2019), Tanno et al. (2019), Aljundi et al. (2019), Molchanov et al. (2019), Webster et al. (2019), Yoo & Kweon (2019), Wang et al. (2019), Zhao et al. (2019), Jiang et al. (2019), Ostapenko et al. (2019), Jaiswal et al. (2019), Taghanaki et al. (2019), Yao et al. (2019), Sagong et al. (2019), Ehret et al. (2019), Jeong et al. (2019), Zhu et al. (2019), Dai et al. (2019), Ding et al. (2019), Lin et al. (2019), Liang et al. (2019), He et al. (2019), Sun et al. (2019), Cai et al. (2019), Tong et al. (2019), Zhu et al. (2019), Kampffmeyer et al. (2019), Zhou et al. (2019), Burlina et al. (2019), Hu et al. (2019), Li et al. (2019), Zhang et al. (2019), Perera et al. (2019), Cheng et al. (2019), (Junbo), Wang et al. (2019), Phillion (2019), Mithun et al. (2019), Majumder & Yao (2019), Kortylewski et al. (2019), Agustsson et al. (2019), Chen et al. (2019), Zhang et al. (2019), Simeoni et al. (2019), Fu et al. (2019), Atzmon & Chechik (2019), Chen et al. (2019), Eghbali & Tahvildari (2019), Benenson et al. (2019), Zhang et al. (2019), Jamal & Qi (2019), Ye et al. (2019), Lei & Chen (2019), Hosseini et al. (2019), Silveira & Jung (2019), Wicker & Kwiatkowska (2019), Zhi et al. (2019), Chabra et al. (2019), Campbell et al. (2019), Hasson et al. (2019), Lopez et al. (2019), Facil et al. (2019), Du et al. (2019), Wang et al. (2019), You et al. (2019), Ku et al. (2019), Liu et al. (2019), Hu et al. (2019), Dong & Yang (2019), Wang et al. (2019), Niu et al. (2019), Li et al. (2019), Yu & Grauman (2019), Liu et al. (2019), Jiang et al. (2019), Li et al. (2019), Kreiss et al. (2019), Song et al. (2019), Morais et al. (2019), Zhang et al. (2019), Su et al. (2019), Shi et al. (2019), Nguyen & Okatani (2019), Ghadiyaram et al. (2019), Qiu et al. (2019), Kukleva et al. (2019), Piao et al. (2019), Zhang et al. (2019), Zhong et al. (2019), Geneva et al. (2019), Gopalakrishnan et al. (2019), Zhao et al. (2019), Grigorev et al. (2019), Jenni & Favaro (2019), Chen et al. (2019), Yu & Grauman (2019), Li et al. (2019), Yuan et al. (2019), Zheng et al. (2019), Zhao et al. (2019), Bianco & Cusano (2019), Lee et al. (2019), Yedidia et al. (2019), Ranjan et al. (2019), Wang et al. (2019), Wang et al. (2019), Wang et al. (2019), Gallego et al. (2019), Shi et al. (2019), Stoffregen & Kleeman (2019), Gomez-Villa et al. (2019), Yezzi et al. (2019), Yoo & Kweon (2019), Kim et al. (2019), Uemori et al. (2019), Osawa et al. (2019), Li et al. (2019), Ho et al. (2019), Dwivedi & Roig (2019), Cholakkal et al. (2019), Rolinek et al. (2019), Mou et al. (2019), Lohit et al. (2019), Zhang et al. (2019), Imran et al. (2019), Kim et al. (2019), Biten et al. (2019), Akbari et al. (2019), Aafaq et al. (2019), Li et al. (2019), Bracha & Chechik (2019), Shuster et al. (2019), Nguyen & Okatani (2019), Chen et al. (2019), Schwartz et al. (2019), Cerrone et al. (2019), Kim et al. (2019), Zhang et al. (2019), Zhang et al. (2019), Tokunaga et al. (2019), Orsic et al. (2019), Cucurull et al. (2019), James et al. (2019), Liao et al. (2019), Wang et al. (2019), Retsinas et al. (2019), Broome et al. (2019), Meyer et al. (2019), Liu et al. (2019), Lang et al. (2019), Huang et al. (2019), Sarlin et al. (2019), Robinson et al. (2019), Zhao et al. (2019), Das et al. (2018), Misra et al. (2018), Bai et al. (2018), Yang et al. (2018), Chang et al. (2018), Mueller et al. (2018), Poier et al. (2018), Fang et al. (2018), Wei et al. (2018), Spurr et al. (2018), Ma et al. (2018), Bulat & Tzimiropoulos (2018), Si et al. (2018), Eriksson et al. (2018), Camposeco et al. (2018), Briaies et al. (2018), Luo et al. (2018), Haefner et al. (2018), Zhang & Funkhouser (2018), Yu et al. (2018), Deng et al. (2018), Yang et al. (2018), Groueix et al. (2018), Yang et al. (2018), Barath (2018), Xu et al. (2018), Kumar et al. (2018), Feng et al. (2018), Sun et al. (2018), Qi et al. (2018), Tekin et al. (2018), Tulsiani et al. (2018), Xian et al. (2018), ?, Lee et al. (2018), Zhan et al. (2018), Girdhar et al. (2018), Dong et al. (2018), Li et al. (2018), Dong et al. (2018), Liu et al. (2018), Li et al. (2018), Garcia-Hernando et al. (2018), Saquib Sarfraz et al. (2018), Kumar et al. (2018), Wang et al. (2018), Zhou et al. (2018), Pavlakos et al. (2018), Baradel et al. (2018), Choi et al. (2018), Sun et al. (2018), Meyer et al. (2018), Bideau et al. (2018), Dong et al. (2018), Zhou et al. (2018), Lin & Hung (2018), Zhu et al. (2018), Xue et al. (2018), Tu et al. (2018), Li et al. (2018), Zhang & Funkhouser (2018), He et al. (2018), Wang et al. (2018), Maninis et al. (2018), Huang et al. (2018), Vasu et al. (2018), Yi et al. (2018), Cheng et al. (2018), Khan & Sundaramoorthi (2018), Xu et al. (2018), Wang et al. (2018), Zhang & Funkhouser (2018), Yu et al. (2018), Zhang & Funkhouser (2018), Hui et al. (2018), Lin & Hung (2018), Reddy Mopuri et al. (2018), Liang et al. (2018), Ren & Jae Lee (2018), Hadad et al. (2018), Merget et al. (2018), Huang et al. (2018), Song et al. (2018), Shen (2018), Shen (2018), Liu et al. (2018), Wang et al. (2018), Weiler et al. (2018), Acuna et al. (2018), Fey et al. (2018), Kossaiifi et al. (2018), Arnab et al. (2018), Wang et al. (2018), Yu et al. (2018), Qi et al. (2018),

Zhang & Funkhouser (2018), Ren & Jae Lee (2018), Li et al. (2018), Kong & Fowlkes (2018), Noh et al. (2018), Chuang et al. (2018), Hua et al. (2018), Deng et al. (2018), Zhu et al. (2018), Jae Hwang et al. (2018), Song et al. (2018), Lee et al. (2018), Chen et al. (2018), Zhou et al. (2018), Kalayeh et al. (2018), Fan & Zhou (2018), Singh et al. (2018), Li et al. (2018), Uijlings et al. (2018), Kim et al. (2018), Ehret & Arias (2018), Chao et al. (2018), Xiao et al. (2018), Wang et al. (2018), Liu et al. (2018), Chen et al. (2018), Song et al. (2018), Chen et al. (2018), Sung et al. (2018), Caesar et al. (2018), Johnson et al. (2018), Cao et al. (2018), Jayaraman & Grauman (2018), Wang et al. (2018), Yang et al. (2018), Chen et al. (2018), Ge et al. (2018), Cao et al. (2018), Wan et al. (2018), Yu et al. (2018), Xu et al. (2018), Zhang & Funkhouser (2018), Hong et al. (2018), Chen et al. (2018), Wang et al. (2018), Shen (2018), Zhang & Funkhouser (2018), Wang et al. (2018), Sun et al. (2018), Hu et al. (2018), Lee et al. (2018), Cheng et al. (2018), Wang et al. (2018), Adel Bargal et al. (2018), Yang et al. (2018), Xu et al. (2018), Wang et al. (2018), Zlateski et al. (2018), Chang et al. (2018), Hu et al. (2018), Bai et al. (2018), Qi et al. (2018), Tulyakov et al. (2018), Pan et al. (2018), Honari et al. (2018), Pal & Balasubramanian (2018), ?, Lee et al. (2018), Gordon et al. (2018), Zhou et al. (2018), Wang et al. (2018), Laude et al. (2018), Eykholt et al. (2018), Joo et al. (2018), Zeng et al. (2018), Han et al. (2018), Haris et al. (2018), Chen et al. (2018), Cahill et al. (2018), Abdelhamed et al. (2018), Niklaus & Liu (2018), Wang et al. (2018), Jeon et al. (2018), Sironi et al. (2018), Zhang & Funkhouser (2018), Kat et al. (2018), Song et al. (2018), Takeda et al. (2018), Liao et al. (2018), Wang et al. (2018), Yang et al. (2018), Prashnani et al. (2018), Tang et al. (2018), Zhang & Funkhouser (2018), Wu et al. (2018), Gilbert et al. (2018), Yu et al. (2018), Wei et al. (2018), Hong et al. (2018), Litany et al. (2018), Zulqarnain Gilani & Mian (2018), Dinesh Reddy et al. (2018), Zhi et al. (2018), Price et al. (2018), Richter & Roth (2018), He et al. (2018), Stutz & Geiger (2018), Georgakis et al. (2018), Liu et al. (2018), Yin & Shi (2018), Pritts et al. (2018), Fu et al. (2018), Miraldo et al. (2018), Wang et al. (2018), Wang et al. (2018), Li et al. (2018), Zou et al. (2018), Batsos et al. (2018), Pang et al. (2018), Liu et al. (2018), Zhao et al. (2018), Nie et al. (2018), Chang et al. (2018), Xu et al. (2018), Wu et al. (2018), Fang et al. (2018), Zanfir et al. (2018), Marinouiu et al. (2018), Yang et al. (2018), Xu et al. (2018), Peng & Wang (2018), Cherian et al. (2018), Zhao et al. (2018), Huang et al. (2018), Peng & Wang (2018), Feng et al. (2018), Yao et al. (2018), Gupta et al. (2018), Shen (2018), Wang et al. (2018), Li et al. (2018), Shi et al. (2018), Shen (2018), Zhang & Funkhouser (2018), Pernici et al. (2018), Guo & Cheung (2018), Xu et al. (2018), Hold-Geoffroy et al. (2018), Xiong et al. (2018), Kligler et al. (2018), Silva et al. (2018), Ding et al. (2018), Yu et al. (2018), Yang et al. (2018), Zhong et al. (2018), Kligvasser et al. (2018), Yu et al. (2018), Rott Shaham & Michaeli (2018), Hu et al. (2018), Zhang & Funkhouser (2018), Qian et al. (2018), Chen et al. (2018), Mildenhall et al. (2018), Qu et al. (2018), Zhang & Funkhouser (2018), Su et al. (2018), Kostrikov et al. (2018), Tewari et al. (2018), Bloesch et al. (2018), Wang et al. (2018), Liu et al. (2018), Wang et al. (2018), Verma et al. (2018), Agudo et al. (2018), Brahmhatt et al. (2018), Huang et al. (2018), Yuan et al. (2018), Slavcheva et al. (2018), Nath Kundu et al. (2018), Yi et al. (2018), Korman et al. (2018), Zanfir et al. (2018), Zhang & Funkhouser (2018), Jacob et al. (2018), Van Horn et al. (2018), Cao et al. (2018), Jenni & Favaro (2018), Zhu et al. (2018), Huang et al. (2018), Keller et al. (2018), Liu et al. (2018), Duan et al. (2018), Yu et al. (2018), Atapour-Abarghouei & Breckon (2018), Liang et al. (2018), Huang et al. (2018), Teo et al. (2018), Ben Tanfous et al. (2018), Turek & Huth (2018), Xu et al. (2018), Shi et al. (2018), Li et al. (2018), Li et al. (2018), Tulsiani et al. (2018), Isokane et al. (2018), Liao et al. (2018), Muralikrishnan et al. (2018), Mo et al. (2018), Im et al. (2018), ?, Fang et al. (2018), Sun et al. (2018), Larsson et al. (2018), Vongkulbhisal et al. (2018), Chu et al. (2018), Zhang & Funkhouser (2018), Grabner et al. (2018), Li et al. (2018), Poms et al. (2018), Chen et al. (2018), Shin et al. (2018), Pan et al. (2018), Zhao et al. (2018), Liu et al. (2018), Barnea & Ben-Shahar (2018), Palacio et al. (2018), Shocher et al. (2018), Wang et al. (2018), Mosinska et al. (2018), Bauchet & Lafarge (2018), Chen et al. (2018), Yair & Michaeli (2018), Gou et al. (2018), Wloka et al. (2018), Zhang & Funkhouser (2018), Lefkimmatis (2018), Li et al. (2018), Jo et al. (2018), Liu et al. (2018), Li et al. (2018), Ren & Jae Lee (2018), Zhang & Funkhouser (2018), Vasu et al. (2018), Lei et al. (2018), Chen et al. (2018), Zhang & Funkhouser (2018), Juefei-Xu et al. (2018), Hoshen & Wolf (2018), Mukherjee et al. (2018), Chen et al. (2018), Douze et al. (2018), Zhang & Funkhouser (2018), Gast & Roth (2018), Sabokrou et al. (2018), Akhtar et al. (2018), Hu et al. (2018), Siarohin et al. (2018), Homayounfar et al. (2018), Kolouri et al. (2018), Zhang & Funkhouser (2018), Kozerawski & Turk (2018), Ikami et al. (2018), Mejjati et al. (2018), Yang et al. (2018), Deshpande et al. (2018), ?, Regmi & Borji (2018), Dekel et al. (2018), Suzuki et al. (2018), Birdal et al. (2018), Chen et al. (2018), Zhou et al. (2018), Nath Kundu et al. (2018), Luo

et al. (2018), Singh et al. (2018), Hu et al. (2018), Shen (2018), Gurari et al. (2018), Babu Sam et al. (2018), Choi et al. (2018), Novotny et al. (2018), Douze et al. (2018), Li et al. (2018), Ghasedi Dizaji et al. (2018), Anderson et al. (2018), Yang et al. (2018), Mohapatra et al. (2018), Lee et al. (2018), Zamir et al. (2018), Saito et al. (2018), Wu et al. (2018), Liu et al. (2018), Sankaranarayanan et al. (2018), Fawzi et al. (2018), Mancini et al. (2018), Yang et al. (2018), Zhou et al. (2018), Zhang & Funkhouser (2018), Xie et al. (2018), Mac Aodha et al. (2018), Järemo Lawin et al. (2018), Jie et al. (2018), Song et al. (2018), Yang et al. (2018), Gallego et al. (2018), Bagautdinov et al. (2018), Tatarchenko et al. (2018), Paschalidou et al. (2018), Kato et al. (2018), Xu et al. (2018), Yang et al. (2018), ?, Larsson et al. (2018), Zuffi et al. (2018), Xu et al. (2018), Xia et al. (2018), Engilberge et al. (2018), Tan et al. (2018), LaLonde et al. (2018), Chen et al. (2018), He et al. (2018), Sharma et al. (2018), Chen et al. (2018), Ehsani et al. (2018), Zhao et al. (2018), Cheng et al. (2018), Cai et al. (2018), Gordon et al. (2018), Liu et al. (2018), Cui et al. (2018), Radosavovic et al. (2018), Balajee Vasudevan et al. (2018), Zhai et al. (2018), Wang et al. (2018), Zhang & Funkhouser (2018), Kim et al. (2018), Roveri et al. (2018), Bozek et al. (2018), Bhattacharyya et al. (2018), Zhang & Funkhouser (2018), Wang et al. (2018), Teney et al. (2018), Hu et al. (2018), Li et al. (2018), Zhuang et al. (2018), Zhang & Funkhouser (2018), Wang et al. (2018), Verma et al. (2018), Cao et al. (2018), Faraone et al. (2018), Bernard et al. (2018), Zhang & Funkhouser (2018), Chen et al. (2018), Rozantsev et al. (2018), Kim et al. (2018), Senocak et al. (2018), Gidaris & Komodakis (2018), Wang et al. (2018), Johnston et al. (2018), Mentzer et al. (2018), Skafte Detlefsen et al. (2018), Berman et al. (2018), Poursaeed et al. (2018), Yu et al. (2018), Kanbak et al. (2018), Zhu et al. (2018), Kumar Roy et al. (2018), Angelina Uy & Hee Lee (2018), Yu et al. (2018), Zhou et al. (2018), Murez et al. (2018), Sandler et al. (2018), Niu et al. (2018), Schilling et al. (2018), Zhuang et al. (2018), Shen (2018), Landrieu & Simonovsky (2018), Zhu et al. (2018), Dai et al. (2018), Lan et al. (2018), Yun & Sim (2018), Xie et al. (2018), Liu et al. (2018), Kim et al. (2018), Cao et al. (2018), Fu et al. (2018), Brachmann & Rother (2018), Rad et al. (2018), Kim et al. (2018), Pumarola et al. (2018), Sadeghi et al. (2018), Ma et al. (2018), Urooj & Borji (2018), Bastani et al. (2018), Paul & Roulletiotis (2018), Rematas et al. (2018), Shin et al. (2018), Liang et al. (2018), Nie et al. (2018), Wan et al. (2018), Zhang & Funkhouser (2018), Lao & Ait-Aider (2018), Tanaka et al. (2018), Meshgi et al. (2018), Bapat et al. (2018), He et al. (2018), Wang et al. (2018), Wang et al. (2018), Wang et al. (2018), Tang et al. (2018), Wang et al. (2018), Wang et al. (2018), Li et al. (2018), Bouritsas et al. (2018), Zhang & Funkhouser (2018), Jain et al. (2018), Mascharka et al. (2018), Xu et al. (2018), Wang et al. (2018), Agrawal et al. (2018), Ahn & Kwak (2018), Fouhey et al. (2018), Inoue et al. (2018), Kanezaki et al. (2018), He et al. (2018), Chavdarova et al. (2018), Miao et al. (2018), Sun et al. (2018), Shin Yoon et al. (2018), Han et al. (2018), Moon et al. (2018), Zheng et al. (2018), Huang et al. (2018), Zhang & Funkhouser (2018), Cheng et al. (2018), Zhu et al. (2018), Luvizon et al. (2018), Wan et al. (2018), Zhong et al. (2018), Andriluka et al. (2018), Wu et al. (2018), Cao et al. (2018), Liu et al. (2018), Luo et al. (2018), Liu et al. (2018), Li et al. (2018), Narayana et al. (2018), Shen (2018), Yang et al. (2018), Wang et al. (2018), Xu et al. (2018), Pan et al. (2018), Madsen et al. (2018), Piergiovanni & Ryoo (2018), Wang et al. (2018), Tang et al. (2018), Xu et al. (2018), Abu Farha et al. (2018), Ren & Jae Lee (2018), Si et al. (2018), Zhou et al. (2018), Shi et al. (2018), Zangir et al. (2018), Li et al. (2018), Chang et al. (2018), Maqueda et al. (2018), Hu et al. (2018), Wei et al. (2018), Lee et al. (2018), Li et al. (2018), Wang et al. (2018), Dorta et al. (2018), Tokozume et al. (2018), Volpi et al. (2018), Yu et al. (2018), Sharma et al. (2018), Lin & Hung (2018), ?, Xian et al. (2018), Tanaka et al. (2018), Aneja et al. (2018), Cheng et al. (2018), Mallasto & Feragen (2018), Gan et al. (2018), Firman et al. (2018), Abdullah Jamal et al. (2018), Kobayashi (2018), Mostajabi et al. (2018), ?, Kaffe et al. (2018), Ma et al. (2018), Mahjourian et al. (2018), Liu et al. (2018), Liu et al. (2018), Zhao et al. (2018), ?, Chao et al. (2018), Joo et al. (2018), You et al. (2018), Li et al. (2018), Jain et al. (2018), Shen (2018), Koniusz et al. (2018), Lin & Hung (2018), Tian et al. (2018), Cui et al. (2018), Zhang & Funkhouser (2018), Qi et al. (2018), Zellers et al. (2018), Tan et al. (2018), Dhawale et al. (2018), Wang et al. (2018), Chen et al. (2018), Sage et al. (2018), Bertasius et al. (2018), Qi et al. (2018), Liao et al. (2018), Veit et al. (2018), Park et al. (2018), Gao et al. (2018), Huang et al. (2018), Gavriluyuk et al. (2018), Possas et al. (2018), Bao et al. (2018), Richard et al. (2018), Li et al. (2018), Yu et al. (2018), Fan & Zhou (2018), Wu et al. (2018), Ristani & Tomasi (2018), Gu et al. (2018), Doughty et al. (2018), Hasan et al. (2018), Anderson et al. (2018), Nguyen & Okatani (2018), Massiceti et al. (2018), Wu et al. (2018), Li et al. (2018), Yeh et al. (2018), Liang et al. (2018), Ehsani et al. (2018), Cai et al. (2018), Huang et al. (2018), Christie et al. (2018), Peng & Wang (2018), Rao et al. (2018), Zhang & Funkhouser (2018), Hui et al. (2018), Xu et al.

(2018), Blau & Michaeli (2018), Zhou et al. (2018), Mirdehghan et al. (2018), Smith et al. (2018), Baradad et al. (2018), Tlusty et al. (2018), Chen et al. (2018), Sengupta et al. (2018), Chen et al. (2018), Meka et al. (2018), Zhang & Funkhouser (2018), Jin et al. (2018), Anirudh et al. (2018), Men et al. (2018), Fajtl et al. (2018), Pan et al. (2018), Su et al. (2018), Srinivasan et al. (2018), Sakakibara et al. (2018), Levis et al. (2018), Mahesh Mohan & Rajagopalan (2018), Huang et al. (2018), Can Karaimer & Brown (2018), Tran et al. (2018), Fan & Zhou (2018), Yang et al. (2018), Sultani et al. (2018), Zhou et al. (2018), Yang et al. (2018), Ding et al. (2018), Li et al. (2018), Li et al. (2018), Liu et al. (2018), Hara et al. (2018), Xu et al. (2018), Zhao et al. (2018), Gao et al. (2018), Zhang & Funkhouser (2018), Bilinski & Prisacariu (2018), Kaneko et al. (2018), Li et al. (2018), Sajjadi et al. (2018), Zhang & Funkhouser (2018), Li et al. (2018), Chen et al. (2018), Yang et al. (2018), Baslamisli et al. (2018), Yoo et al. (2018), Korman et al. (2018), Tesfaldet et al. (2018), Bao et al. (2018), Akkaynak & Treibitz (2018), Barath (2018), Lei et al. (2018), Nguyen & Okatani (2018), Zhang & Funkhouser (2018), Lan et al. (2018), Zhang & Funkhouser (2018), Ma et al. (2018), Wei et al. (2018), Zhang & Funkhouser (2018), Nilsson & Sminchisescu (2018), Wu et al. (2018), Chen et al. (2018), Zhang & Funkhouser (2018), Wang et al. (2018), Krishna et al. (2018), Tychsen-Smith & Petersson (2018), Shen (2018), ?, Gonzalez-Garcia et al. (2018), Rocco et al. (2018), Gao et al. (2018), Liu et al. (2018), Pirinen & Sminchisescu (2018), Lu et al. (2018), Luo et al. (2018), Ma et al. (2018), Liu et al. (2018), Zhang & Funkhouser (2018), Tung et al. (2018), Huang et al. (2018), Choutas et al. (2018), Zhang & Funkhouser (2018), Wang et al. (2018), He et al. (2018), Kumar Roy et al. (2018), He et al. (2018), Wang et al. (2018), Deng et al. (2018), Chen et al. (2018), Chu et al. (2018), Kanazawa et al. (2018), Hu et al. (2018), Amirul Islam et al. (2018), Zhang & Funkhouser (2018), Hsiao & Grauman (2018), Niu et al. (2018), Gu et al. (2018), Wang et al. (2018), Taira et al. (2018), Zhu et al. (2018), Lu et al. (2018), Qiao et al. (2018), Chen et al. (2018), Cao et al. (2018), Hu et al. (2018), Wei et al. (2018), Wang et al. (2018), Yu et al. (2018), ?, Pavlakos et al. (2018), Speciale et al. (2018), Vianello et al. (2018), Wu et al. (2018), Tran et al. (2018), Zhao et al. (2018), Huang et al. (2018), Wug Oh et al. (2018), Richard et al. (2018), Sigurdsson et al. (2018), Zhao et al. (2018), Cheng et al. (2018), Zhou et al. (2018), Kanehira et al. (2018), Fujimura et al. (2018), Hu et al. (2018), Li et al. (2018), Tsai et al. (2018), Kendall et al. (2018), Li et al. (2018), Gorji & Clark (2018), Wang et al. (2018), Fan & Zhou (2018), Andreopoulos et al. (2018), Han et al. (2018), Lyu et al. (2018), Azadi et al. (2018), Shlizerman et al. (2018), Yang et al. (2018), Yagi et al. (2018), Annadani & Biswas (2018), Ravi et al. (2018), Wang et al. (2018), Iscen et al. (2018), Iscen et al. (2018), Yang et al. (2018), Liu et al. (2018), Zhang & Funkhouser (2018), Patro & Namboodiri (2018), Niu et al. (2018), Ramanishka et al. (2018), Ak et al. (2018), Wehrmann & Barros (2018), Liu et al. (2018), Su et al. (2018), Deng et al. (2018), Song et al. (2018), Mallya & Lazebnik (2018), Wang et al. (2018), Cihan Camgoz et al. (2018), Wang et al. (2018), Baraldi et al. (2018), Chen et al. (2018), Su et al. (2018), Long et al. (2018), Feichtenhofer et al. (2018), Hao et al. (2018), Park et al. (2018), Tung et al. (2018), Shanu et al. (2018), Chen et al. (2018), Dolhansky & Canton Ferrer (2018), Zhang & Funkhouser (2018), Zhuang et al. (2018), Kuen et al. (2018), Wang et al. (2018), Lv et al. (2018), Sun et al. (2018), Wu et al. (2018), Chen et al. (2018), Hong et al. (2018), Chen et al. (2018), Pinheiro (2018), Riaz Muhammad et al. (2018), ?, Sznaiier & Camps (2018), Wang et al. (2018), Wei et al. (2018), Shen (2018), Marsden et al. (2018), Teja Mullanpudi et al. (2018), Xu et al. (2018), Russo et al. (2018), Lezama et al. (2018), Rebuffi et al. (2018), Lin & Hung (2018), Amayo et al. (2018), Ikami et al. (2018), Zhang & Funkhouser (2018), Lui et al. (2018), Tao et al. (2018), Kupyn et al. (2018), Li et al. (2018), Li et al. (2018), Galdran et al. (2018), Gu et al. (2018), Zhang & Funkhouser (2018), Sheng et al. (2018), Yokota et al. (2018), Shen (2018), Duan et al. (2018), Yu et al. (2018), Li et al. (2018), Xu et al. (2018), Baumgartner et al. (2018), Joo et al. (2018), Baek et al. (2018), Balakrishnan et al. (2018), Liu et al. (2018), Gkioxari et al. (2018), Sener & Yao (2018), Genova et al. (2018), Alldieck et al. (2018), Hu et al. (2018), Huynh et al. (2018), Ge et al. (2018), Nagrani et al. (2018), Rhodin et al. (2018), Zhang & Funkhouser (2018), Xian et al. (2018), Orekondy et al. (2018), Henriques & Vedaldi (2018), Bhattacharyya et al. (2018), Puig et al. (2018), Sankaranarayanan et al. (2018), Ghosh et al. (2018), An et al. (2018), ?, Qian et al. (2018), Rupprecht et al. (2018), Khruklov & Oseledets (2018), Prakash et al. (2018), Vicol et al. (2018), Mathews et al. (2018), Sattler et al. (2018), Liu et al. (2018), Pumarola et al. (2018), Xie et al. (2018), Villegas et al. (2018), Chen et al. (2018), Gong et al. (2018), Kim et al. (2018), Kim et al. (2018), Wang et al. (2018), Zoph et al. (2018), Ren & Jae Lee (2018), Chen et al. (2018), Fong & Vedaldi (2018), Zhou et al. (2018), Dogan et al. (2018), Liu et al. (2018), Van Horn et al. (2018), Park et al. (2018), Choi et al. (2018), Wang et al. (2018), Qi et al. (2018), Wu et al. (2018), Zhang & Funkhouser

(2018), Huang et al. (2018), Xie et al. (2018), Esser et al. (2018), Liu et al. (2018), Marcos et al. (2018), Lambert et al. (2018), Luo et al. (2018), Wang et al. (2018), Chandra et al. (2018), Shin et al. (2018), Sun et al. (2018), Fan & Zhou (2018), Yellin et al. (2018), Sun et al. (2018), Li et al. (2018), Hui et al. (2018), Song et al. (2018), Jiang et al. (2018), Runia et al. (2018), Kong & Fowlkes (2018), Zhang & Funkhouser (2018), Li et al. (2018), Wang et al. (2018), Teixeira et al. (2018), Xia et al. (2018), Han et al. (2018), Liu et al. (2018), Bibi et al. (2018), Saeedan et al. (2018), Wan et al. (2018), Wu et al. (2018), Hu et al. (2018), Alperovich et al. (2018), Gao et al. (2018), Mehr et al. (2018), Konyushkova et al. (2018), Dong et al. (2018), Yu et al. (2018), Le & Duan (2018), Li et al. (2018), Graham et al. (2018), Chen et al. (2018), Zhang & Funkhouser (2018), Balakrishnan et al. (2018), Yan et al. (2018), ?, Jiang et al. (2018), Dalca et al. (2018), Raposo & Barreto (2018), Caicedo et al. (2018), Haehn et al. (2018), Wang et al. (2018), Nathan Mundhenk et al. (2018), Keshari et al. (2018), Noroozi et al. (2018), Beluch et al. (2018), Ye et al. (2018), Tabernik et al. (2018), Li et al. (2018), Chavdarova et al. (2018), Chen et al. (2018), Zhou et al. (2018), Zhu et al. (2018), Ulyanov et al. (2018), Lin & Hung (2018), Chen et al. (2018), Teney et al. (2017), Zhao et al. (2017), Juefei-Xu et al. (2017), Aksoy et al. (2017), Trigeorgis et al. (2017), Booth et al. (2017), Kiran Adhikarla et al. (2017), Kotaru & Katti (2017), Tanaka et al. (2017), Haeusser et al. (2017), Queau et al. (2017), Varol et al. (2017), Long & Hua (2017), Hyeong Hong et al. (2017), Wang et al. (2017), Qin et al. (2017), Lea et al. (2017), Gurumurthy et al. (2017), Talmi et al. (2017), Boukhayma et al. (2017), Li et al. (2017), Mahasseni et al. (2017), Liu et al. (2017), Caelles et al. (2017), Seki & Pollefeys (2017), Ganju et al. (2017), Vedantam et al. (2017), Cevikalp & Triggs (2017), Godard et al. (2017), Larsson & Olsson (2017), Ren et al. (2017), Nam et al. (2017), Wijmans & Furukawa (2017), Krause et al. (2017), Das et al. (2017), Lee et al. (2017), Zhang et al. (2017), He et al. (2017), Kong & Fowlkes (2017), Lu et al. (2017), Li et al. (2017), Yan et al. (2017), Chen et al. (2017), Liu et al. (2017), Mustafa & Hilton (2017), Garcia-Hernando & Kim (2017), Arnab & Torr (2017), Jampani et al. (2017), Michel et al. (2017), Yu et al. (2017), Hu et al. (2017), Yu et al. (2017), Wang et al. (2017), Ye et al. (2017), Zhou et al. (2017), Zhang et al. (2017), Proenca & Neves (2017), Chao et al. (2017), Zhang et al. (2017), Takahashi et al. (2017), Law et al. (2017), Sigurdsson et al. (2017), Wang et al. (2017), Fan et al. (2017), Al-Halah & Stiefelhagen (2017), Lai et al. (2017), Zhou et al. (2017), Durand et al. (2017), Qi et al. (2017), Tian et al. (2017), Niklaus et al. (2017), Wan et al. (2017), Cao et al. (2017), Wu et al. (2017), Zhang et al. (2017), Zhang et al. (2017), Kang et al. (2017), Da et al. (2017), Kehl et al. (2017), Richard et al. (2017), Xue et al. (2017), Ma et al. (2017), Huang et al. (2017), Liu et al. (2017), Ito & Okatani (2017), Lin et al. (2017), Larsson & Olsson (2017), Veit et al. (2017), Veit et al. (2017), Liang et al. (2017), Bertasius et al. (2017), Zhai et al. (2017), Khoreva et al. (2017), Barron & Tsai (2017), Chunseong Park et al. (2017), Mostegel et al. (2017), Diba et al. (2017), Wang et al. (2017), Gong et al. (2017), Logothetis et al. (2017), Hu et al. (2017), Dong et al. (2017), Girdhar et al. (2017), Dave et al. (2017), Hu et al. (2017), Bernard et al. (2017), Liang et al. (2017), Vondrick & Torralba (2017), Mahasseni et al. (2017), Figurnov et al. (2017), Su & Hua (2017), Zhang et al. (2017), Ke et al. (2017), Zhao et al. (2017), Ge & Yu (2017), Hussein et al. (2017), Abbaspour Tehrani et al. (2017), Hu et al. (2017), Isola et al. (2017), Chattopadhyay et al. (2017), Simon et al. (2017), Zhu et al. (2017), Xu et al. (2017), Wang et al. (2017), Duan et al. (2017), Akhtar et al. (2017), Yang et al. (2017), Cui et al. (2017), Li et al. (2017), Ioannou et al. (2017), Sandhan & Young Choi (2017), Chollet (2017), Richardson et al. (2017), Qian et al. (2017), Su & Hua (2017), Xu et al. (2017), Yan et al. (2017), Zamir et al. (2017), Zhong et al. (2017), Cao et al. (2017), Li et al. (2017), Li et al. (2017), Yang et al. (2017), Zheng et al. (2017), Jie et al. (2017), Slavcheva et al. (2017), Mueller et al. (2017), Tran et al. (2017), Tran et al. (2017), Liu et al. (2017), Pascoe et al. (2017), Isack et al. (2017), Caba Heilbron et al. (2017), Zhu et al. (2017), Kong & Fowlkes (2017), Schonberger et al. (2017), Xie et al. (2017), Su & Hua (2017), Arsalan Soltani et al. (2017), Zhao et al. (2017), Wang et al. (2017), O'Toole et al. (2017), Gu et al. (2017), Cui et al. (2017), Wei et al. (2017), Yang et al. (2017), Plotz & Roth (2017), Swoboda et al. (2017), Swoboda et al. (2017), Swoboda et al. (2017), Long & Hua (2017), Sattler et al. (2017), Liu et al. (2017), Baraldi et al. (2017), Kosti et al. (2017), Kim & Lee (2017), Shi et al. (2017), Kong & Fowlkes (2017), Hussain et al. (2017), Bibi et al. (2017), Baque et al. (2017), Chunseong Park et al. (2017), Song et al. (2017), Halber & Funkhouser (2017), Moosavi-Dezfooli et al. (2017), Tavakoli et al. (2017), Elhamifar & Clara De Paolis Kaluza (2017), Misra et al. (2017), Zeng et al. (2017), Yeo et al. (2017), Savinov et al. (2017), Chu et al. (2017), Li et al. (2017), Zhou et al. (2017), Zhang et al. (2017), Nakamura et al. (2017), Zhuang et al. (2017), Le et al. (2017), Chen et al. (2017), Chen et al. (2017), Shen et al. (2017), Lin et al. (2017), Trager et al. (2017), Patrini et al. (2017), Shen

et al. (2017), Liu et al. (2017), Li et al. (2017), Zendel et al. (2017), Ge & Yu (2017), Rebuffi et al. (2017), Iqbal et al. (2017), Zhang et al. (2017), Almazan et al. (2017), Chabot et al. (2017), Ding et al. (2017), Tepper & Sapiro (2017), Chan et al. (2017), Iscen et al. (2017), Yang et al. (2017), Wang et al. (2017), Shrivastava et al. (2017), Lin et al. (2017), Rota Bulò et al. (2017), Kim & Lee (2017), Dekel et al. (2017), Ji et al. (2017), Blasinski et al. (2017), Xu et al. (2017), Huang et al. (2017), Yang et al. (2017), Luo et al. (2017), Chang et al. (2017), Zeng et al. (2017), Elhabian & Whitaker (2017), Huang et al. (2017), Gao et al. (2017), Zhou et al. (2017), Yan et al. (2017), Yi et al. (2017), Rengarajan et al. (2017), Hu et al. (2017), Huang et al. (2017), Gong et al. (2017), Diba et al. (2017), Knobelreiter et al. (2017), Zhu et al. (2017), Li et al. (2017), Pansari & Pawan Kumar (2017), Tolias & Chum (2017), Li et al. (2017), Rezende et al. (2017), Lin et al. (2017), Osman Ulusoy et al. (2017), Yu et al. (2017), Wei et al. (2017), Lee et al. (2017), Poggi & Mattoccia (2017), Ilg et al. (2017), Wang et al. (2017), Feng et al. (2017), Murdock & De la Torre (2017), Tome et al. (2017), Gorji & Clark (2017), Lam et al. (2017), Bai et al. (2017), Kim & Lee (2017), Shi et al. (2017), Wu et al. (2017), Lin et al. (2017), Deng et al. (2017), Veeravasaru et al. (2017), Wang et al. (2017), Wang et al. (2017), Gupta et al. (2017), Tulsiani et al. (2017), Tulsiani et al. (2017), Chen et al. (2017), Zhu et al. (2017), Perazzi et al. (2017), Marino et al. (2017), Ge & Yu (2017), Ryan Fanello et al. (2017), Pathak et al. (2017), Yun et al. (2017), Wang et al. (2017), Wang et al. (2017), Tang et al. (2017), Hyeong Hong et al. (2017), Jang et al. (2017), Hayat et al. (2017), Yang et al. (2017), Palmer et al. (2017), Sawatzky et al. (2017), Valmadre et al. (2017), Strecke et al. (2017), Moreno-Noguer (2017), Qin et al. (2017), Tang et al. (2017), Li et al. (2017), Liu et al. (2017), Liu et al. (2017), Zhao et al. (2017), Martinez et al. (2017), Johnson et al. (2017), Buch et al. (2017), Cui et al. (2017), Peng et al. (2017), Straub et al. (2017), Ithapu et al. (2017), Treible et al. (2017), Xu et al. (2017), Usumezbas et al. (2017), Bak & Carr (2017), Liu et al. (2017), Yang et al. (2017), Salvador et al. (2017), Cheng et al. (2017), Guo & Chao (2017), Wang et al. (2017), Zhang et al. (2017), Gholami & Pavlovic (2017), Dai et al. (2017), Chen et al. (2017), Cosmin Duta et al. (2017), Li et al. (2017), Li et al. (2017), Mao et al. (2017), Gan et al. (2017), Tai et al. (2017), Wang et al. (2017), Yu et al. (2017), Kodirov et al. (2017), Jevnisek & Avidan (2017), Li et al. (2017), Hou et al. (2017), Zhang et al. (2017), Cherian et al. (2017), Jiang & Li (2017), Zhou et al. (2017), Bailer et al. (2017), Schops et al. (2017), Xiong et al. (2017), Li et al. (2017), Ke et al. (2017), Ajanthan et al. (2017), Sun et al. (2017), Lv et al. (2017), Vestner et al. (2017), Malti & Herzet (2017), Kaltenmark et al. (2017), Han et al. (2017), Aljundi et al. (2017), Kar et al. (2017), Tokmakov et al. (2017), You et al. (2017), Walecki et al. (2017), Xiao et al. (2017), Armagan et al. (2017), Rogez et al. (2017), Jun Koh & Kim (2017), Hu et al. (2017), Shi et al. (2017), Wu et al. (2017), Sun et al. (2017), Xu et al. (2017), Chunseong Park et al. (2017), Jin et al. (2017), He et al. (2017), Roy & Todorovic (2017), Tang et al. (2017), Ravi et al. (2017), Kim & Lee (2017), Kim & Lee (2017), Riegler et al. (2017), Lefkimiatis (2017), Janai et al. (2017), Tian et al. (2017), Li et al. (2017), Jin et al. (2017), Fernando et al. (2017), Shen et al. (2017), Kayaba & Kokumai (2017), Dutt Jain et al. (2017), Yoo et al. (2017), Yuan et al. (2017), Simonovsky & Komodakis (2017), Cole et al. (2017), Zhang et al. (2017), Bousmalis et al. (2017), Yokota & Hontani (2017), Zhou et al. (2017), Amirul Islam et al. (2017), Yu et al. (2017), Gu et al. (2017), Kalogerakis et al. (2017), Tsai et al. (2017), Xu et al. (2017), Morteza Safdarnejad & Liu (2017), Zhang et al. (2017), Chen et al. (2017), Yan et al. (2017), Herath et al. (2017), Fu et al. (2017), Zhang et al. (2017), Chen et al. (2017), Nah et al. (2017), Wang et al. (2017), Liu et al. (2017), Li et al. (2017), Li et al. (2017), Zhang et al. (2017), Taniai et al. (2017), Santa Cruz et al. (2017), Srinivasan et al. (2017), Shimano et al. (2017), Jiang & Li (2017), Gatys et al. (2017), Chen et al. (2017), Yan et al. (2017), Wang et al. (2017), Wang et al. (2017), Shen et al. (2017), Takatani et al. (2017), Cheng et al. (2017), Jiang & Li (2017), Qu et al. (2017), Mandal et al. (2017), Hu et al. (2017), Haouchine & Cotin (2017), Vongkulbhisal et al. (2017), Karlinsky et al. (2017), Shih et al. (2017), Yim et al. (2017), Xia et al. (2017), Pohlen et al. (2017), Ranjan & Black (2017), Weng et al. (2017), Bian et al. (2017), Zhang et al. (2017), Jeon & Kim (2017), Ren et al. (2017), Song et al. (2017), Gomez et al. (2017), Khan et al. (2017), Lao & Sundaramoorthi (2017), Chang et al. (2017), Wu et al. (2017), Zhang et al. (2017), Antunes et al. (2017), Koller et al. (2017), Dong et al. (2017), Bagautdinov et al. (2017), Wang et al. (2017), Zhang et al. (2017), Jia et al. (2017), Peng et al. (2017), Yang et al. (2017), Zhang et al. (2017), Pan et al. (2017), Ramakrishnan et al. (2017), Jiang & Li (2017), Joon Oh et al. (2017), Liu et al. (2017), Zhang et al. (2017), Fu et al. (2017), Vasu & Rajagopalan (2017), Cavallari et al. (2017), Nguyen et al. (2017), Koniusz et al. (2017), Sheng et al. (2017), Arvanitopoulos et al. (2017), Hosang et al. (2017), Guan & Smith (2017), Karessli et al. (2017), Ma et al. (2017), Camposeco et al. (2017), Cohen & Weinshall (2017),

Zweig & Wolf (2017), Zhang et al. (2017), Xian et al. (2017), Wang et al. (2017), Eisenschtat & Wolf (2017), Wigness & Rogers (2017), Esmaeili et al. (2017), Elbaz et al. (2017), Shaked & Wolf (2017), Achanta & Susstrunk (2017), Borghi et al. (2017), Wulff et al. (2017), Ledig et al. (2017), Miksik et al. (2017), Huang et al. (2017), Yu et al. (2017), Mai et al. (2017), Feichtenhofer et al. (2017), Mo et al. (2017), Zhou et al. (2017), Roberto de Souza et al. (2017), Feichtenhofer et al. (2017), Caballero et al. (2017), Sharghi et al. (2017), Sengupta et al. (2017), Choi et al. (2017), Lathuiliere et al. (2017), Dibra et al. (2017), He et al. (2017), Albl et al. (2017), Kong & Fowlkes (2017), Yuan et al. (2017), Yuan et al. (2017), Shahpaski et al. (2017), Zhang et al. (2017), Papandreou et al. (2017), Kukulova et al. (2017), Gorelick et al. (2017), Akkaynak et al. (2017), Speciale et al. (2017), Schuster et al. (2017), Briaies & Gonzalez-Jimenez (2017), Zhai et al. (2017), Rohrbach et al. (2017), Luan et al. (2017), Kembhavi et al. (2017), Kirillov et al. (2017), Venkateswara et al. (2017), Worrall et al. (2017), Ummenhofer et al. (2017), Dansereau et al. (2017), Stone et al. (2017), Xie et al. (2017), Huang et al. (2017), Chen et al. (2017), Sagawa & Satoh (2017), Oyallon (2017), Monti et al. (2017), Fan et al. (2017), Izadinia et al. (2017), Saito et al. (2017), Yeung et al. (2017), Tran et al. (2017), Balntas et al. (2017), Chen et al. (2017), Brahmhatt & Hays (2017), Rozumnyi et al. (2017), Homayounfar et al. (2017), Bai et al. (2017), Castrejon et al. (2017), Wang et al. (2017), Gidaris & Komodakis (2017), Wang et al. (2017), Sagonas et al. (2017), Novotny et al. (2017), Zhang et al. (2017), Real et al. (2017), Toderici et al. (2017), Yang et al. (2017), Dai et al. (2017), Lu et al. (2017), Dian et al. (2017), Xu et al. (2017), Xu et al. (2017), Chen et al. (2017), Song et al. (2017), Zhu et al. (2017), Sangkloy et al. (2017), Xu et al. (2017), Ren et al. (2017), Zhuo et al. (2017), Han et al. (2017), Yang et al. (2017), Chunseong Park et al. (2017), Li et al. (2017), Du et al. (2017), Yeh et al. (2017), Rong et al. (2017), de Vries et al. (2017), Zhu et al. (2017), Shu et al. (2017), Zhang et al. (2017), Shu et al. (2017), Zhou et al. (2017), Abdalnabi et al. (2017), Li et al. (2017), Yuan et al. (2017), Zhang et al. (2017), Wang et al. (2017), Santhanam et al. (2017), Son et al. (2017), Gan et al. (2017), Elhoseiny et al. (2017), Zhu et al. (2017), Chen et al. (2017), Wu et al. (2017), Zhang et al. (2017), Yang et al. (2017), Hayder et al. (2017), Makihara et al. (2017), Sun et al. (2017), Sasaki et al. (2017), Shou et al. (2017), Babu Sam et al. (2017), Venugopalan et al. (2017), Deng et al. (2017), Lin et al. (2017), Plummer et al. (2017), Liu et al. (2017), Alireza Golestaneh & Karam (2017), Zhang et al. (2017), Ikami et al. (2017), Dai et al. (2017), Dong et al. (2017), Jang et al. (2017), Wang et al. (2017), Dai et al. (2017), Bappy et al. (2017), Ehsan Abbasnejad et al. (2017), Zhang et al. (2017), Dou et al. (2017), Cai et al. (2017), Han et al. (2017), Kong & Fowlkes (2017), Xiao et al. (2017), Guo & Chao (2017), Yu et al. (2017), Kendall & Cipolla (2017), Guo & Chao (2017), He et al. (2017), Barath et al. (2017), Levinkov et al. (2017), Jiang & Li (2017), Rozantsev et al. (2017), Sinha et al. (2017), Lassner et al. (2017), Morgado & Vasconcelos (2017), Huang et al. (2017), Alameda-Pineda et al. (2017), Kaneko et al. (2017), Huang et al. (2017), Schober et al. (2017), Wang et al. (2017), Kokkinos (2017), Peng et al. (2017), Rocco et al. (2017), Butepage et al. (2017), Thermos et al. (2017), Xie et al. (2017), Hao et al. (2017), Chakraborty et al. (2017), Rao Jerripothula et al. (2017), Babenko & Lempitsky (2017), Kumar et al. (2017), Bogo et al. (2017), Tateno et al. (2017), Khue Le-Huu & Paragios (2017), Agudo & Moreno-Noguer (2017), Sicre et al. (2017), Yurchenko & Lempitsky (2017), Popa et al. (2017), Carreira & Zisserman (2017), Lukezic et al. (2017), Wu et al. (2017), Surh et al. (2017), Morley & Foroosh (2017), Hu et al. (2017), Li et al. (2017), Zuffi et al. (2017), Papadopoulos et al. (2017), Zhu et al. (2017), Tseng et al. (2017), Yan et al. (2017), Shamai & Kimmel (2017), Kim & Lee (2017), Zhang et al. (2017), Sheinin et al. (2017), Son Chung et al. (2017), Insafutdinov et al. (2017), Brattoli et al. (2017), Su & Hua (2017), Dutt Jain et al. (2017), Li et al. (2017), Pan et al. (2017), Joshi et al. (2017), Lu et al. (2017), Huang et al. (2017), Bau et al. (2017), Jetley et al. (2017), Kim & Lee (2017), Haussmann et al. (2017), Yao et al. (2017), Gordo & Larlus (2017), Maninchedda et al. (2017), Luo et al. (2017), Do et al. (2017), Lezama et al. (2017), Danelljan et al. (2017), Kuznetsov et al. (2017), Ren et al. (2017), Ke et al. (2017), Daniel Costea et al. (2017), Brachmann et al. (2017), Sanchez Giraldo et al. (2017), Krull et al. (2017), Tamaazousti et al. (2017), Yang et al. (2017), Pei et al. (2017), Levis et al. (2017), Nguyen et al. (2017), Qiu et al. (2017), Xia et al. (2017), Dolz et al. (2017), Nestmeyer & Gehler (2017), Alp Guler et al. (2017), Spampinato et al. (2017), Zhang et al. (2017), Papoutsakis et al. (2017), Deshpande et al. (2017), Paul et al. (2017), Clark et al. (2017), Gross et al. (2017), Larsson & Olsson (2017), Maharaj et al. (2017), Rashid et al. (2017), Goyal et al. (2017), Ufer & Ommer (2017), Ulyanov et al. (2017), Devrim Kaba et al. (2017), Kalayeh et al. (2017), Schulter et al. (2017), Sun et al. (2017), Liu et al. (2017), Lopez-Paz et al. (2017), Pavlakos et al. (2017), Kovacs et al. (2017), Rennie et al. (2017), Pavlakos et al. (2017), Chen et al. (2017), Nech & Kemelmacher-Shlizerman

(2017), Panda et al. (2017), Upchurch et al. (2017), Mousavian et al. (2017), Panda et al. (2017), Xie et al. (2017), Luo et al. (2017), Deutsch et al. (2017), Bagherinezhad et al. (2017), Bautista et al. (2017), Ye et al. (2017), Azadi et al. (2017), Vernaza & Chandraker (2017), Tzeng et al. (2017), Jaimez et al. (2017), Iyyer et al. (2017), Yatskar et al. (2017), Ramanishka et al. (2017), Tsai et al. (2017), Ke et al. (2017), Zhu et al. (2017), Amir et al. (2017), Zaki et al. (2017), Redmon & Farhadi (2017), Wang et al. (2017), Yu et al. (2017), Cao et al. (2017), Kannan et al. (2017), Huang et al. (2017), Hold-Geoffroy et al. (2017), Hyeong Hong et al. (2017), Haeffele & Vidal (2017), Zhou et al. (2017), Dai et al. (2017), Cui et al. (2017), Yu et al. (2017), Liu et al. (2017), Xu et al. (2017), Xie et al. (2017), Gao et al. (2017), Zhang et al. (2017), Mi et al. (2017), Sun et al. (2017), Zhang et al. (2017), Dixit et al. (2017), Yang et al. (2017), Branson et al. (2017), Anne Hendricks et al. (2016), Mao et al. (2016), Yang et al. (2016), Noh et al. (2016), Andreas et al. (2016), Reed et al. (2016), Akata et al. (2016), Xian et al. (2016), Kwitt et al. (2016), Gan et al. (2016), Vondrick et al. (2016), Moo Yi et al. (2016), Zhou et al. (2016), Wang et al. (2016), Hamid Rezaatofghi et al. (2016), Zhu et al. (2016), Feng et al. (2016), Liu et al. (2016), Maire et al. (2016), Khoreva et al. (2016), Yang et al. (2016), Wu et al. (2016), Ofir et al. (2016), Shen et al. (2016), Liu et al. (2016), Fu et al. (2016), Zhang et al. (2016), Singh et al. (2016), Xie et al. (2016), Yang et al. (2016), Laptev et al. (2016), Simo-Serra & Ishikawa (2016), Quan et al. (2016), Gao et al. (2016), Yang et al. (2016), Ravindran & Mittal (2016), Hu & Lin (2016), Chen et al. (2016), Chen et al. (2016), Xu et al. (2016), Gurari et al. (2016), Kihara et al. (2016), Royer et al. (2016), Erdil et al. (2016), Zhu et al. (2016), Park et al. (2016), Lotan & Irani (2016), Kulkarni et al. (2016), Pan et al. (2016), Cheng et al. (2016), Li & Yu (2016), Baek et al. (2016), Mai et al. (2016), Chen et al. (2016), Bruce et al. (2016), Wloka & Tsotsos (2016), Wang et al. (2016), Volokitin et al. (2016), Frigo et al. (2016), Calvet et al. (2016), Herranz et al. (2016), Rhinehart & Kitani (2016), Zhang et al. (2016), Pan et al. (2016), Najafi et al. (2016), Dasgupta et al. (2016), Zhu et al. (2016), Liang et al. (2016), Lu et al. (2016), Liu et al. (2016), Lee et al. (2016), Zhang et al. (2016), Liu et al. (2016), Quan et al. (2016), Jang et al. (2016), Moo Yi et al. (2016), Del Pero et al. (2016), Perazzi et al. (2016), Hasan et al. (2016), Maerki et al. (2016), Zhang et al. (2016), Shrivastava et al. (2016), He et al. (2016), Redmon et al. (2016), Gidaris & Komodakis (2016), Yu et al. (2016), Song & Xiao (2016), Kang et al. (2016), Hoffman et al. (2016), Chavali et al. (2016), Kong et al. (2016), Papadopoulos et al. (2016), Ouyang et al. (2016), Rosman et al. (2016), Bardow et al. (2016), Kadambi et al. (2016), Chen et al. (2016), Bouman et al. (2016), Gan et al. (2016), Xiao & Jae Lee (2016), Zhu et al. (2016), Yu et al. (2016), Alahi et al. (2016), Maksai et al. (2016), Yao et al. (2016), Tekin et al. (2016), Gygli et al. (2016), Shahroudy et al. (2016), Ni et al. (2016), Pan et al. (2016), Meng et al. (2016), Shou et al. (2016), Zhang et al. (2016), Jun Koh et al. (2016), Sultani & Shah (2016), Zhang et al. (2016), Liu et al. (2016), Zhang et al. (2016), Zhang et al. (2016), Zhou et al. (2016), Zhang et al. (2016), Zhang et al. (2016), Cui et al. (2016), Wang et al. (2016), Huang et al. (2016), Lin et al. (2016), Son et al. (2016), Zhang et al. (2016), Kobayashi (2016), Dar & Moses (2016), Haque et al. (2016), Zhang et al. (2016), Xiao & Jae Lee (2016), Zhang et al. (2016), Chen et al. (2016), Zhang et al. (2016), Wang et al. (2016), Li & Yu (2016), Peng et al. (2016), Cao et al. (2016), McLaughlin et al. (2016), Cheng et al. (2016), You et al. (2016), Cho & Yoon (2016), Matsukawa et al. (2016), Wang et al. (2016), Perez-Rua et al. (2016), Hong Yoon et al. (2016), Bertinetto et al. (2016), Yang et al. (2016), Tao et al. (2016), Danelljan et al. (2016), Bibi et al. (2016), Cui et al. (2016), Diego & Hamprecht (2016), Lapin et al. (2016), Zantedeschi et al. (2016), Zhang et al. (2016), Motiian et al. (2016), Rahmani & Mian (2016), Fouhey et al. (2016), Ren & Sudderth (2016), Armeni et al. (2016), Wei et al. (2016), DeGol et al. (2016), Bendale & Boulton (2016), Wang et al. (2016), Sattler et al. (2016), Wolff et al. (2016), Pramod & Arun (2016), Hackel et al. (2016), Li & Yu (2016), Pan et al. (2016), Kim et al. (2016), Kim et al. (2016), Nguyen & Brown (2016), Ma et al. (2016), Berman et al. (2016), Nam et al. (2016), Xie et al. (2016), Lai et al. (2016), Vo et al. (2016), Chhatkuli et al. (2016), Fredriksson et al. (2016), Huang et al. (2016), Diebold et al. (2016), Eriksson et al. (2016), Joo et al. (2016), Han et al. (2016), Luo et al. (2016), Zheng & Kneip (2016), Kukulova et al. (2016), Talker et al. (2016), Danelljan et al. (2016), Gong et al. (2016), Perez-Pellitero et al. (2016), Gast et al. (2016), Hu & Lin (2016), Timofte et al. (2016), Shi et al. (2016), Chang et al. (2016), Ma et al. (2016), Zhou et al. (2016), Caba Heilbron et al. (2016), Fernando et al. (2016), Feichtenhofer et al. (2016), Ma et al. (2016), Li & Yu (2016), Singh et al. (2016), Ibrahim et al. (2016), Lillo et al. (2016), Zhu et al. (2016), Ong & Bober (2016), Heo et al. (2016), Wang et al. (2016), Wieschollek et al. (2016), Zhang et al. (2016), Quynh Nhi Tran et al. (2016), Babenko & Lempitsky (2016), Liu et al. (2016), Iscen et al. (2016), Kontogianni et al. (2016), Huang et al. (2016), Kuzborskij et al. (2016), Zhu et al. (2016), Tang

et al. (2016), Yang et al. (2016), Wang et al. (2016), Chen et al. (2016), Tudor Ionescu et al. (2016), Liu et al. (2016), Krafka et al. (2016), Lahner et al. (2016), Sharmanska et al. (2016), Mottaghi et al. (2016), Shankar et al. (2016), Borji et al. (2016), Lee et al. (2016), Murthy et al. (2016), Qiao et al. (2016), Li & Yu (2016), Qi (2016), Lin et al. (2016), Wang et al. (2016), Wang et al. (2016), Poznanski & Wolf (2016), Gupta et al. (2016), Stewart et al. (2016), Tu et al. (2016), Feng et al. (2016), Lu et al. (2016), Daniel Costea & Nedeveschi (2016), Najibi et al. (2016), Wang et al. (2016), Thies et al. (2016), Tulyakov et al. (2016), Owens et al. (2016), Gatys et al. (2016), Hou et al. (2016), Isack et al. (2016), Kim et al. (2016), Choe et al. (2016), Wug Oh et al. (2016), Lee et al. (2016), Li & Yu (2016), Chen et al. (2016), Shin et al. (2016), Le et al. (2016), Jae Hwang et al. (2016), Shin et al. (2016), Pathak et al. (2016), Lei et al. (2016), Lebedev & Lempitsky (2016), Hayder et al. (2016), Moosavi-Dezfooli et al. (2016), Murdock et al. (2016), Iandola et al. (2016), Rastegar et al. (2016), Jacobsen et al. (2016), Singh et al. (2016), Yonetani et al. (2016), Wang et al. (2016), Soomro et al. (2016), Wang et al. (2016), Yoo et al. (2016), Yeung et al. (2016), Alfaro et al. (2016), Wang et al. (2016), Wang et al. (2016), Zhang et al. (2016), Lee et al. (2016), Li & Yu (2016), Shibata et al. (2016), Wang et al. (2016), Wang et al. (2016), Rengarajan et al. (2016), Fu et al. (2016), Lin et al. (2016), Pan et al. (2016), Zhang et al. (2016), Szegedy et al. (2016), Gupta et al. (2016), Pham et al. (2016), Bilen & Vedaldi (2016), Chan et al. (2016), Dutt Jain & Grauman (2016), Bell et al. (2016), Cheng et al. (2016), Mathe et al. (2016), Huberman & Fattal (2016), Lapuschkin et al. (2016), Zhou et al. (2016), Misra et al. (2016), Castrejon et al. (2016), Cai et al. (2016), Hu & Lin (2016), Zhu et al. (2016), Li & Yu (2016), Wei et al. (2016), Vondrick et al. (2016), Sochor et al. (2016), Liu et al. (2016), Huang et al. (2016), Bilen & Vedaldi (2016), Ramanathan et al. (2016), Mahasseni & Todorovic (2016), Charles et al. (2016), Yang et al. (2016), Xu et al. (2016), Yuan et al. (2016), Ohnishi et al. (2016), Wu et al. (2016), Choi et al. (2016), Richard & Gall (2016), Liu et al. (2016), Dai et al. (2016), Lin et al. (2016), Kundu et al. (2016), Blaha et al. (2016), Liang et al. (2016), Lin et al. (2016), Hong et al. (2016), Cordts et al. (2016), Vemulapalli et al. (2016), Ros et al. (2016), Locher et al. (2016), Kanazawa et al. (2016), Johannsen et al. (2016), Wang et al. (2016), Osman Ulusoy et al. (2016), Schillebeeckx & Pless (2016), Thomas & Taniguchi (2016), Xie et al. (2016), Magri & Fusiello (2016), Verleysen & De Vleeschouwer (2016), Saurer et al. (2016), Trager et al. (2016), Albi et al. (2016), Brachmann et al. (2016), Bushnevskiy et al. (2016), Zafeiriou et al. (2016), Zhao et al. (2016), Wu et al. (2016), Zhu et al. (2016), Piotraschke & Blanz (2016), Zhang et al. (2016), Zhang et al. (2016), Yu et al. (2016), Qin et al. (2016), Zhao et al. (2016), Ham et al. (2016), Sun et al. (2016), Thomas & Taniguchi (2016), Su et al. (2016), Li & Yu (2016), Mottaghi et al. (2016), Harakeh et al. (2016), Altwaijry et al. (2016), Singh et al. (2016), Diba et al. (2016), Cho & Yoon (2016), Hu & Lin (2016), Doumanoglou et al. (2016), Ge et al. (2016), Bertasius et al. (2016), Mattyus et al. (2016), Shuai et al. (2016), Lai et al. (2016), Chen et al. (2016), Souly & Shah (2016), Li & Yu (2016), Kuen et al. (2016), Seguin et al. (2016), Xie et al. (2016), Kolaman et al. (2016), Shi et al. (2016), Wang et al. (2016), Fu et al. (2016), Chang et al. (2016), Heber & Pock (2016), Aggarwal et al. (2016), Sheinin & Schechner (2016), Kobayashi (2016), Yago Vicente et al. (2016), Koller et al. (2016), Li & Yu (2016), Johns et al. (2016), Zhu et al. (2016), Park et al. (2016), Ji et al. (2016), Jayaraman & Grauman (2016), Huang et al. (2016), Yu et al. (2016), Zhang et al. (2016), Sevilla-Lara et al. (2016), Tsai et al. (2016), Law et al. (2016), You et al. (2016), You et al. (2016), Huang et al. (2016), Mollenhoff et al. (2016), Littwin & Wolf (2016), Sharmanska et al. (2016), Chakraborty et al. (2016), Rota Buló & Kotschieder (2016), Misra et al. (2016), Song & Xiao (2016), Lavin & Gray (2016), Li & Yu (2016), Zhang et al. (2016), Mayer et al. (2016), Feng et al. (2016), Ranftl et al. (2016), Mostegel et al. (2016), Handa et al. (2016), Jeon et al. (2016), Ben-Artzi et al. (2016), Schonberger & Frahm (2016), Wang et al. (2016), Kong et al. (2016), Dai et al. (2016), Crocco et al. (2016), Sinha et al. (2016), Zhang et al. (2016), Shi et al. (2016), Trigeorgis et al. (2016), Jourabloo & Liu (2016), Roth et al. (2016), Molchanov et al. (2016), Chang et al. (2016), Bhattarai et al. (2016), Gadot & Wolf (2016), Taniai et al. (2016), Xu et al. (2016), Ning et al. (2016), Sekii (2016), Hoshen & Peleg (2016), Nam et al. (2016), Qi (2016), Liu et al. (2016), Choi et al. (2016), Dhiman et al. (2016), Gaidon et al. (2016), Midorikawa et al. (2016), Queau et al. (2016), Qian et al. (2016), Or-El et al. (2016), Tanaka et al. (2016), Williem & Kyu Park (2016), Li & Yu (2016), Natola et al. (2016), Banerjee et al. (2016), Wang et al. (2016), Karianakis et al. (2016), Jampani et al. (2016), Ju et al. (2016), Vemulapalli et al. (2016), Zheng & Kneip (2016), Xing et al. (2016), Zhang et al. (2016), Rematas et al. (2016), Yang et al. (2016), Rahimi et al. (2016), Stumm et al. (2016), Chen et al. (2016), Hu & Lin (2016), Johnson et al. (2016), Alayrac et al. (2016), Yu et al. (2016), Pan et al. (2016), Chandrasekaran et al. (2016), Shih et al. (2016), Wu et al. (2016), Tapaswi et al. (2016),

Li & Yu (2016), You et al. (2016), Mustafa et al. (2016), Lee et al. (2016), Parashar et al. (2016), Chen et al. (2016), Park et al. (2016), Chen et al. (2016), Chu et al. (2016), Wei et al. (2016), Carreira et al. (2016), Durand et al. (2016), Xie et al. (2016), Smith et al. (2016), Deng et al. (2016), Cohen et al. (2016), Wang et al. (2016), Vemulapalli et al. (2016), Wang et al. (2016), Wu et al. (2016), Dosovitskiy & Brox (2016), Masi et al. (2016), Kan et al. (2016), Sun et al. (2016), Feng et al. (2016), Kemelmacher-Shlizerman et al. (2016), Arandjelovic (2016), Wen et al. (2016), Walecki et al. (2016), Bolkart & Wuhler (2016), Niu et al. (2016), Pishchulin et al. (2016), Kwak et al. (2016), Yasin et al. (2016), Oberweger et al. (2016), Zhou et al. (2016), Kafle & Kanan (2016), Kottur et al. (2016), Zhu et al. (2016), Wang et al. (2016), Zhang et al. (2016), Bai et al. (2016), Zhang et al. (2016), Demisse et al. (2016), Shi et al. (2016), Shi et al. (2016), Yang et al. (2016), Tsai et al. (2016), Marcos et al. (2016), Wu et al. (2016), Trigeorgis et al. (2016), Liu et al. (2016), Canevet & Fleuret (2016), Kanehira & Harada (2016), Yang et al. (2016), Yin et al. (2016), Funk & Liu (2016), Huang et al. (2016), Harandi et al. (2016), Quang Minh et al. (2016), Cheng et al. (2016), Chen et al. (2016), Mukuta & Harada (2016), Mosinska-Domanska et al. (2016), Alameda-Pineda et al. (2016), Lu et al. (2016), Kolouri et al. (2016), Wei et al. (2016), Cholakkal et al. (2016), Xu et al. (2016), Arandjelovic (2016), Dutt Jain & Grauman (2016), Kim et al. (2016), Changpinyo et al. (2016), Fu et al. (2016), Li & Yu (2016), Xu et al. (2016), Shanu et al. (2016), Huang et al. (2016), Kumar B G et al. (2016), Koniusz & Cherian (2016), Chang et al. (2016), Ha et al. (2016), Yang et al. (2016), Firman et al. (2016), Ryan Fanello et al. (2016), Wang et al. (2016), Savinov et al. (2016), Raposo & Barreto (2016), Galliani & Schindler (2016), Radenovic et al. (2016), Eckart et al. (2016), Roy & Todorovic (2016), Flynn et al. (2016), Yang et al. (2016), Yatskar et al. (2016), Booth et al. (2016), Rothe et al. (2016), Fabian Benitez-Quiroz et al. (2016), Ouyang et al. (2016), Sikka et al. (2016), Pal et al. (2016), Hu & Lin (2016), Joseph Tan et al. (2016), Shao et al. (2016), Bernard et al. (2016), Vongkulbhisal et al. (2016), Qi (2016), Zhai et al. (2016), Li & Yu (2016), Nguyen & Brown (2016), Campbell & Petersson (2016), Luo et al. (2016), Hu & Lin (2016), Harwood & Drummond (2016), He et al. (2016), Zhang et al. (2016), Honari et al. (2016), Jetley et al. (2016), Fan et al. (2016), Nhan Duong et al. (2016), Kruthiventi et al. (2016), Zhou et al. (2016), Golyanik et al. (2016), Wang et al. (2016), Oskarsson et al. (2016), Wang et al. (2016), Quan et al. (2016), Baque et al. (2016), Chin et al. (2016), Ajanthan et al. (2016), Joseph Tan et al. (2016), Bylow et al. (2016), Dicle et al. (2016), Shah et al. (2016), Qi (2016), Jug et al. (2016), Nasihatkon et al. (2016), Yang et al. (2016), Zhuang et al. (2016), Bansal et al. (2016), Al-Halah et al. (2016), Zhang et al. (2016), Wang et al. (2016), Wang et al. (2016), Wegner et al. (2016), Massa et al. (2016), Zhang et al. (2016), Yang et al. (2016),

REFERENCES

- Macario O. Cordel , II, Shaojing Fan, Zhiqi Shen, and Mohan S. Kankanhalli. Emotion-aware human attention prediction. In *The IEEE Conference on Computer Vision and Pattern Recognition (CVPR)*, June 2019.
- Nayyer Aafaq, Naveed Akhtar, Wei Liu, Syed Zulqarnain Gilani, and Ajmal Mian. Spatio-temporal dynamics and semantic attribute enriched visual encoding for video captioning. In *The IEEE Conference on Computer Vision and Pattern Recognition (CVPR)*, June 2019.
- Sathyanarayanan N. Aakur and Sudeep Sarkar. A perceptual prediction framework for self supervised event segmentation. In *The IEEE Conference on Computer Vision and Pattern Recognition (CVPR)*, June 2019.
- Davide Abati, Angelo Porrello, Simone Calderara, and Rita Cucchiara. Latent space autoregression for novelty detection. In *The IEEE Conference on Computer Vision and Pattern Recognition (CVPR)*, June 2019.
- Mahdi Abavisani, Hamid Reza Vaezi Joze, and Vishal M. Patel. Improving the performance of unimodal dynamic hand-gesture recognition with multimodal training. In *The IEEE Conference on Computer Vision and Pattern Recognition (CVPR)*, June 2019.
- Ehsan Abbasnejad, Qi Wu, Qinfeng Shi, and Anton van den Hengel. What’s to know? uncertainty as a guide to asking goal-oriented questions. In *The IEEE Conference on Computer Vision and Pattern Recognition (CVPR)*, June 2019.

- Mahdi Abbaspour Tehrani, Thabo Beeler, and Anselm Grundhofer. A practical method for fully automatic intrinsic camera calibration using directionally encoded light. In *The IEEE Conference on Computer Vision and Pattern Recognition (CVPR)*, July 2017.
- Abdelrahman Abdelhamed, Stephen Lin, and Michael S. Brown. A high-quality denoising dataset for smartphone cameras. In *The IEEE Conference on Computer Vision and Pattern Recognition (CVPR)*, June 2018.
- Muhammad Abdullah Jamal, Haoxiang Li, and Boqing Gong. Deep face detector adaptation without negative transfer or catastrophic forgetting. In *The IEEE Conference on Computer Vision and Pattern Recognition (CVPR)*, June 2018.
- Abrrar H. Abdalnabi, Bing Shuai, Stefan Winkler, and Gang Wang. Episodic camn: Contextual attention-based memory networks with iterative feedback for scene labeling. In *The IEEE Conference on Computer Vision and Pattern Recognition (CVPR)*, July 2017.
- Pooya Abolghasemi, Amir Mazaheri, Mubarak Shah, and Ladislau Boloni. Pay attention! - robustifying a deep visuomotor policy through task-focused visual attention. In *The IEEE Conference on Computer Vision and Pattern Recognition (CVPR)*, June 2019.
- Yazan Abu Farha, Alexander Richard, and Juergen Gall. When will you do what? - anticipating temporal occurrences of activities. In *The IEEE Conference on Computer Vision and Pattern Recognition (CVPR)*, June 2018.
- Radhakrishna Achanta and Sabine Susstrunk. Superpixels and polygons using simple non-iterative clustering. In *The IEEE Conference on Computer Vision and Pattern Recognition (CVPR)*, July 2017.
- David Acuna, Huan Ling, Amlan Kar, and Sanja Fidler. Efficient interactive annotation of segmentation datasets with polygon-rnn++. In *The IEEE Conference on Computer Vision and Pattern Recognition (CVPR)*, June 2018.
- David Acuna, Amlan Kar, and Sanja Fidler. Devil is in the edges: Learning semantic boundaries from noisy annotations. In *The IEEE Conference on Computer Vision and Pattern Recognition (CVPR)*, June 2019.
- Sarah Adel Bargal, Andrea Zunino, Donghyun Kim, Jianming Zhang, Vittorio Murino, and Stan Sclaroff. Excitation backprop for rnns. In *The IEEE Conference on Computer Vision and Pattern Recognition (CVPR)*, June 2018.
- Mahmoud Afifi, Brian Price, Scott Cohen, and Michael S. Brown. When color constancy goes wrong: Correcting improperly white-balanced images. In *The IEEE Conference on Computer Vision and Pattern Recognition (CVPR)*, June 2019.
- Rajat Aggarwal, Amrisha Vohra, and Anoop M. Namboodiri. Panoramic stereo videos with a single camera. In *The IEEE Conference on Computer Vision and Pattern Recognition (CVPR)*, June 2016.
- Aishwarya Agrawal, Dhruv Batra, Devi Parikh, and Aniruddha Kembhavi. Don't just assume; look and answer: Overcoming priors for visual question answering. In *The IEEE Conference on Computer Vision and Pattern Recognition (CVPR)*, June 2018.
- Gianluca Agresti, Henrik Schaefer, Piergiorgio Sartor, and Pietro Zanuttigh. Unsupervised domain adaptation for tof data denoising with adversarial learning. In *The IEEE Conference on Computer Vision and Pattern Recognition (CVPR)*, June 2019.
- Antonio Agudo and Francesc Moreno-Noguer. Dust: Dual union of spatio-temporal subspaces for monocular multiple object 3d reconstruction. In *The IEEE Conference on Computer Vision and Pattern Recognition (CVPR)*, July 2017.
- Antonio Agudo, Melcior Pijoan, and Francesc Moreno-Noguer. Image collection pop-up: 3d reconstruction and clustering of rigid and non-rigid categories. In *The IEEE Conference on Computer Vision and Pattern Recognition (CVPR)*, June 2018.

- Eirikur Agustsson, Jasper R. R. Uijlings, and Vittorio Ferrari. Interactive full image segmentation by considering all regions jointly. In *The IEEE Conference on Computer Vision and Pattern Recognition (CVPR)*, June 2019.
- Jiwoon Ahn and Suha Kwak. Learning pixel-level semantic affinity with image-level supervision for weakly supervised semantic segmentation. In *The IEEE Conference on Computer Vision and Pattern Recognition (CVPR)*, June 2018.
- Jiwoon Ahn, Sunghyun Cho, and Suha Kwak. Weakly supervised learning of instance segmentation with inter-pixel relations. In *The IEEE Conference on Computer Vision and Pattern Recognition (CVPR)*, June 2019.
- Thalaiyasingam Ajanthan, Richard Hartley, and Mathieu Salzmann. Memory efficient max flow for multi-label submodular mrfs. In *The IEEE Conference on Computer Vision and Pattern Recognition (CVPR)*, June 2016.
- Thalaiyasingam Ajanthan, Alban Desmaison, Rudy Bunel, Mathieu Salzmann, Philip H. S. Torr, and M. Pawan Kumar. Efficient linear programming for dense crfs. In *The IEEE Conference on Computer Vision and Pattern Recognition (CVPR)*, July 2017.
- Kenan E. Ak, Ashraf A. Kassim, Joo Hwee Lim, and Jo Yew Tham. Learning attribute representations with localization for flexible fashion search. In *The IEEE Conference on Computer Vision and Pattern Recognition (CVPR)*, June 2018.
- Zeynep Akata, Mateusz Malinowski, Mario Fritz, and Bernt Schiele. Multi-cue zero-shot learning with strong supervision. In *The IEEE Conference on Computer Vision and Pattern Recognition (CVPR)*, June 2016.
- Hassan Akbari, Svebor Karaman, Surabhi Bhargava, Brian Chen, Carl Vondrick, and Shih-Fu Chang. Multi-level multimodal common semantic space for image-phrase grounding. In *The IEEE Conference on Computer Vision and Pattern Recognition (CVPR)*, June 2019.
- Naveed Akhtar, Ajmal Mian, and Fatih Porikli. Joint discriminative bayesian dictionary and classifier learning. In *The IEEE Conference on Computer Vision and Pattern Recognition (CVPR)*, July 2017.
- Naveed Akhtar, Jian Liu, and Ajmal Mian. Defense against universal adversarial perturbations. In *The IEEE Conference on Computer Vision and Pattern Recognition (CVPR)*, June 2018.
- Derya Akkaynak and Tali Treibitz. A revised underwater image formation model. In *The IEEE Conference on Computer Vision and Pattern Recognition (CVPR)*, June 2018.
- Derya Akkaynak and Tali Treibitz. Sea-thru: A method for removing water from underwater images. In *The IEEE Conference on Computer Vision and Pattern Recognition (CVPR)*, June 2019.
- Derya Akkaynak, Tali Treibitz, Tom Shlesinger, Yossi Loya, Raz Tamir, and David Iluz. What is the space of attenuation coefficients in underwater computer vision? In *The IEEE Conference on Computer Vision and Pattern Recognition (CVPR)*, July 2017.
- Yagiz Aksoy, Tunc Ozan Aydin, and Marc Pollefeys. Designing effective inter-pixel information flow for natural image matting. In *The IEEE Conference on Computer Vision and Pattern Recognition (CVPR)*, July 2017.
- Ziad Al-Halah and Rainer Stiefelwagen. Automatic discovery, association estimation and learning of semantic attributes for a thousand categories. In *The IEEE Conference on Computer Vision and Pattern Recognition (CVPR)*, July 2017.
- Ziad Al-Halah, Makarand Tapaswi, and Rainer Stiefelwagen. Recovering the missing link: Predicting class-attribute associations for unsupervised zero-shot learning. In *The IEEE Conference on Computer Vision and Pattern Recognition (CVPR)*, June 2016.
- Alexandre Alahi, Kratarth Goel, Vignesh Ramanathan, Alexandre Robicquet, Li Fei-Fei, and Silvio Savarese. Social lstm: Human trajectory prediction in crowded spaces. In *The IEEE Conference on Computer Vision and Pattern Recognition (CVPR)*, June 2016.

- Xavier Alameda-Pineda, Elisa Ricci, Yan Yan, and Nicu Sebe. Recognizing emotions from abstract paintings using non-linear matrix completion. In *The IEEE Conference on Computer Vision and Pattern Recognition (CVPR)*, June 2016.
- Xavier Alameda-Pineda, Andrea Pilzer, Dan Xu, Nicu Sebe, and Elisa Ricci. Viraliency: Pooling local virality. In *The IEEE Conference on Computer Vision and Pattern Recognition (CVPR)*, July 2017.
- Huda Alamri, Vincent Cartillier, Abhishek Das, Jue Wang, Anoop Cherian, Irfan Essa, Dhruv Batra, Tim K. Marks, Chiori Hori, Peter Anderson, Stefan Lee, and Devi Parikh. Audio visual scene-aware dialog. In *The IEEE Conference on Computer Vision and Pattern Recognition (CVPR)*, June 2019.
- Jean-Baptiste Alayrac, Piotr Bojanowski, Nishant Agrawal, Josef Sivic, Ivan Laptev, and Simon Lacoste-Julien. Unsupervised learning from narrated instruction videos. In *The IEEE Conference on Computer Vision and Pattern Recognition (CVPR)*, June 2016.
- Jean-Baptiste Alayrac, Joao Carreira, and Andrew Zisserman. The visual centrifuge: Model-free layered video representations. In *The IEEE Conference on Computer Vision and Pattern Recognition (CVPR)*, June 2019.
- Cenek Albl, Zuzana Kukelova, and Tomas Pajdla. Rolling shutter absolute pose problem with known vertical direction. In *The IEEE Conference on Computer Vision and Pattern Recognition (CVPR)*, June 2016.
- Cenek Albl, Zuzana Kukelova, Andrew Fitzgibbon, Jan Heller, Matej Smid, and Tomas Pajdla. On the two-view geometry of unsynchronized cameras. In *The IEEE Conference on Computer Vision and Pattern Recognition (CVPR)*, July 2017.
- Michael A. Alcorn, Qi Li, Zhitao Gong, Chengfei Wang, Long Mai, Wei-Shinn Ku, and Anh Nguyen. Strike (with) a pose: Neural networks are easily fooled by strange poses of familiar objects. In *The IEEE Conference on Computer Vision and Pattern Recognition (CVPR)*, June 2019.
- Anali Alfaro, Domingo Mery, and Alvaro Soto. Action recognition in video using sparse coding and relative features. In *The IEEE Conference on Computer Vision and Pattern Recognition (CVPR)*, June 2016.
- Amit Alfassy, Leonid Karlinsky, Amit Aides, Joseph Shtok, Sivan Harary, Rogerio Feris, Raja Giryes, and Alex M. Bronstein. Laso: Label-set operations networks for multi-label few-shot learning. In *The IEEE Conference on Computer Vision and Pattern Recognition (CVPR)*, June 2019.
- Yazeed Alharbi, Neil Smith, and Peter Wonka. Latent filter scaling for multimodal unsupervised image-to-image translation. In *The IEEE Conference on Computer Vision and Pattern Recognition (CVPR)*, June 2019.
- S. Alireza Golestaneh and Lina J. Karam. Spatially-varying blur detection based on multiscale fused and sorted transform coefficients of gradient magnitudes. In *The IEEE Conference on Computer Vision and Pattern Recognition (CVPR)*, July 2017.
- Raied Aljadaany, Dipan K. Pal, and Marios Savvides. Douglas-rachford networks: Learning both the image prior and data fidelity terms for blind image deconvolution. In *The IEEE Conference on Computer Vision and Pattern Recognition (CVPR)*, June 2019.
- Rahaf Aljundi, Punarjay Chakravarty, and Tinne Tuytelaars. Expert gate: Lifelong learning with a network of experts. In *The IEEE Conference on Computer Vision and Pattern Recognition (CVPR)*, July 2017.
- Rahaf Aljundi, Klaas Kelchtermans, and Tinne Tuytelaars. Task-free continual learning. In *The IEEE Conference on Computer Vision and Pattern Recognition (CVPR)*, June 2019.

- Thiemo Alldieck, Marcus Magnor, Weipeng Xu, Christian Theobalt, and Gerard Pons-Moll. Video based reconstruction of 3d people models. In *The IEEE Conference on Computer Vision and Pattern Recognition (CVPR)*, June 2018.
- Thiemo Alldieck, Marcus Magnor, Bharat Lal Bhatnagar, Christian Theobalt, and Gerard Pons-Moll. Learning to reconstruct people in clothing from a single rgb camera. In *The IEEE Conference on Computer Vision and Pattern Recognition (CVPR)*, June 2019.
- Emilio J. Almazan, Ron Tal, Yiming Qian, and James H. Elder. Mcmlsd: A dynamic programming approach to line segment detection. In *The IEEE Conference on Computer Vision and Pattern Recognition (CVPR)*, July 2017.
- Riza Alp Guler, George Trigeorgis, Epameinondas Antonakos, Patrick Snape, Stefanos Zafeiriou, and Iasonas Kokkinos. Densereg: Fully convolutional dense shape regression in-the-wild. In *The IEEE Conference on Computer Vision and Pattern Recognition (CVPR)*, July 2017.
- Anna Alperovich, Ole Johannsen, Michael Strecke, and Bastian Goldluecke. Light field intrinsics with a deep encoder-decoder network. In *The IEEE Conference on Computer Vision and Pattern Recognition (CVPR)*, June 2018.
- Hani Altwaijry, Eduard Trulls, James Hays, Pascal Fua, and Serge Belongie. Learning to match aerial images with deep attentive architectures. In *The IEEE Conference on Computer Vision and Pattern Recognition (CVPR)*, June 2016.
- Paul Amayo, Pedro Piniés, Lina M. Paz, and Paul Newman. Geometric multi-model fitting with a convex relaxation algorithm. In *The IEEE Conference on Computer Vision and Pattern Recognition (CVPR)*, June 2018.
- Arnon Amir, Brian Taba, David Berg, Timothy Melano, Jeffrey McKinstry, Carmelo Di Nolfo, Tapan Nayak, Alexander Andreopoulos, Guillaume Garreau, Marcela Mendoza, Jeff Kusnitz, Michael Debole, Steve Esser, Tobi Delbruck, Myron Flickner, and Dharmendra Modha. A low power, fully event-based gesture recognition system. In *The IEEE Conference on Computer Vision and Pattern Recognition (CVPR)*, July 2017.
- Md Amirul Islam, Mrigank Rochan, Neil D. B. Bruce, and Yang Wang. Gated feedback refinement network for dense image labeling. In *The IEEE Conference on Computer Vision and Pattern Recognition (CVPR)*, July 2017.
- Md Amirul Islam, Mahmoud Kalash, and Neil D. B. Bruce. Revisiting salient object detection: Simultaneous detection, ranking, and subitizing of multiple salient objects. In *The IEEE Conference on Computer Vision and Pattern Recognition (CVPR)*, June 2018.
- Matthew Amodio and Smita Krishnaswamy. Travelgan: Image-to-image translation by transformation vector learning. In *The IEEE Conference on Computer Vision and Pattern Recognition (CVPR)*, June 2019.
- Wangpeng An, Haoqian Wang, Qingyun Sun, Jun Xu, Qionghai Dai, and Lei Zhang. A pid controller approach for stochastic optimization of deep networks. In *The IEEE Conference on Computer Vision and Pattern Recognition (CVPR)*, June 2018.
- Peter Anderson, Qi Wu, Damien Teney, Jake Bruce, Mark Johnson, Niko Sünderhauf, Ian Reid, Stephen Gould, and Anton van den Hengel. Vision-and-language navigation: Interpreting visually-grounded navigation instructions in real environments. In *The IEEE Conference on Computer Vision and Pattern Recognition (CVPR)*, June 2018.
- Jacob Andreas, Marcus Rohrbach, Trevor Darrell, and Dan Klein. Neural module networks. In *The IEEE Conference on Computer Vision and Pattern Recognition (CVPR)*, June 2016.
- Alexander Andreopoulos, Hira J. Kashyap, Tapan K. Nayak, Arnon Amir, and Myron D. Flickner. A low power, high throughput, fully event-based stereo system. In *The IEEE Conference on Computer Vision and Pattern Recognition (CVPR)*. June 2018.

- Mykhaylo Andriluka, Umar Iqbal, Eldar Insafutdinov, Leonid Pishchulin, Anton Milan, Juergen Gall, and Bernt Schiele. Posetrack: A benchmark for human pose estimation and tracking. In *The IEEE Conference on Computer Vision and Pattern Recognition (CVPR)*, June 2018.
- Jyoti Aneja, Aditya Deshpande, and Alexander G. Schwing. Convolutional image captioning. In *The IEEE Conference on Computer Vision and Pattern Recognition (CVPR)*, June 2018.
- Mikaela Angelina Uy and Gim Hee Lee. Pointnetvlad: Deep point cloud based retrieval for large-scale place recognition. In *The IEEE Conference on Computer Vision and Pattern Recognition (CVPR)*, June 2018.
- Rushil Anirudh, Hyojin Kim, Jayaraman J. Thiagarajan, K. Aditya Mohan, Kyle Champley, and Timo Bremer. Lose the views: Limited angle ct reconstruction via implicit sinogram completion. In *The IEEE Conference on Computer Vision and Pattern Recognition (CVPR)*, June 2018.
- Yashas Annadani and Soma Biswas. Preserving semantic relations for zero-shot learning. In *The IEEE Conference on Computer Vision and Pattern Recognition (CVPR)*, June 2018.
- Lisa Anne Hendricks, Subhashini Venugopalan, Marcus Rohrbach, Raymond Mooney, Kate Saenko, and Trevor Darrell. Deep compositional captioning: Describing novel object categories without paired training data. In *The IEEE Conference on Computer Vision and Pattern Recognition (CVPR)*, June 2016.
- Michel Antunes, Joao P. Barreto, Djamila Aouada, and Bjorn Ottersten. Unsupervised vanishing point detection and camera calibration from a single manhattan image with radial distortion. In *The IEEE Conference on Computer Vision and Pattern Recognition (CVPR)*, July 2017.
- Yasuhiro Aoki, Hunter Goforth, Rangaprasad Arun Srivatsan, and Simon Lucey. Pointnetlk: Robust efficient point cloud registration using pointnet. In *The IEEE Conference on Computer Vision and Pattern Recognition (CVPR)*, June 2019.
- Ognjen Arandjelovic. Learnt quasi-transitive similarity for retrieval from large collections of faces. In *The IEEE Conference on Computer Vision and Pattern Recognition (CVPR)*, June 2016.
- Nikita Araslanov, Constantin A. Rothkopf, and Stefan Roth. Actor-critic instance segmentation. In *The IEEE Conference on Computer Vision and Pattern Recognition (CVPR)*, June 2019.
- Anil Armagan, Martin Hirzer, Peter M. Roth, and Vincent Lepetit. Learning to align semantic segmentation and 2.5d maps for geolocalization. In *The IEEE Conference on Computer Vision and Pattern Recognition (CVPR)*, July 2017.
- Iro Armeni, Ozan Sener, Amir R. Zamir, Helen Jiang, Ioannis Brilakis, Martin Fischer, and Silvio Savarese. 3d semantic parsing of large-scale indoor spaces. In *The IEEE Conference on Computer Vision and Pattern Recognition (CVPR)*, June 2016.
- Anurag Arnab and Philip H. S. Torr. Pixelwise instance segmentation with a dynamically instantiated network. In *The IEEE Conference on Computer Vision and Pattern Recognition (CVPR)*, July 2017.
- Anurag Arnab, Ondrej Miksik, and Philip H.S. Torr. On the robustness of semantic segmentation models to adversarial attacks. In *The IEEE Conference on Computer Vision and Pattern Recognition (CVPR)*, June 2018.
- Anurag Arnab, Carl Doersch, and Andrew Zisserman. Exploiting temporal context for 3d human pose estimation in the wild. In *The IEEE Conference on Computer Vision and Pattern Recognition (CVPR)*, June 2019.
- Amir Arsalan Soltani, Haibin Huang, Jiajun Wu, Tejas D. Kulkarni, and Joshua B. Tenenbaum. Synthesizing 3d shapes via modeling multi-view depth maps and silhouettes with deep generative networks. In *The IEEE Conference on Computer Vision and Pattern Recognition (CVPR)*, July 2017.

- Aditya Arun, C.V. Jawahar, and M. Pawan Kumar. Dissimilarity coefficient based weakly supervised object detection. In *The IEEE Conference on Computer Vision and Pattern Recognition (CVPR)*, June 2019.
- Nikolaos Arvanitopoulos, Radhakrishna Achanta, and Sabine Susstrunk. Single image reflection suppression. In *The IEEE Conference on Computer Vision and Pattern Recognition (CVPR)*, July 2017.
- Amir Atapour-Abarghouei and Toby P. Breckon. Real-time monocular depth estimation using synthetic data with domain adaptation via image style transfer. In *The IEEE Conference on Computer Vision and Pattern Recognition (CVPR)*, June 2018.
- Amir Atapour-Abarghouei and Toby P. Breckon. Veritatem dies aperit - temporally consistent depth prediction enabled by a multi-task geometric and semantic scene understanding approach. In *The IEEE Conference on Computer Vision and Pattern Recognition (CVPR)*, June 2019.
- Yuval Atzmon and Gal Chechik. Adaptive confidence smoothing for generalized zero-shot learning. In *The IEEE Conference on Computer Vision and Pattern Recognition (CVPR)*, June 2019.
- Armen Avetisyan, Manuel Dahnert, Angela Dai, Manolis Savva, Angel X. Chang, and Matthias Niessner. Scan2cad: Learning cad model alignment in rgb-d scans. In *The IEEE Conference on Computer Vision and Pattern Recognition (CVPR)*, June 2019.
- Gil Avraham, Yan Zuo, and Tom Drummond. Parallel optimal transport gan. In *The IEEE Conference on Computer Vision and Pattern Recognition (CVPR)*, June 2019.
- Samaneh Azadi, Jiashi Feng, and Trevor Darrell. Learning detection with diverse proposals. In *The IEEE Conference on Computer Vision and Pattern Recognition (CVPR)*, July 2017.
- Samaneh Azadi, Matthew Fisher, Vladimir G. Kim, Zhaowen Wang, Eli Shechtman, and Trevor Darrell. Multi-content gan for few-shot font style transfer. In *The IEEE Conference on Computer Vision and Pattern Recognition (CVPR)*, June 2018.
- Sina Mokhtarzadeh Azar, Mina Ghadimi Atigh, Ahmad Nickabadi, and Alexandre Alahi. Convolutional relational machine for group activity recognition. In *The IEEE Conference on Computer Vision and Pattern Recognition (CVPR)*, June 2019.
- Nicolas Aziere and Sinisa Todorovic. Ensemble deep manifold similarity learning using hard proxies. In *The IEEE Conference on Computer Vision and Pattern Recognition (CVPR)*, June 2019.
- Dejan Azinovic, Tzu-Mao Li, Anton Kaplanyan, and Matthias Niessner. Inverse path tracing for joint material and lighting estimation. In *The IEEE Conference on Computer Vision and Pattern Recognition (CVPR)*, June 2019.
- Artem Babenko and Victor Lempitsky. Efficient indexing of billion-scale datasets of deep descriptors. In *The IEEE Conference on Computer Vision and Pattern Recognition (CVPR)*, June 2016.
- Artem Babenko and Victor Lempitsky. Product split trees. In *The IEEE Conference on Computer Vision and Pattern Recognition (CVPR)*, July 2017.
- Deepak Babu Sam, Shiv Surya, and R. Venkatesh Babu. Switching convolutional neural network for crowd counting. In *The IEEE Conference on Computer Vision and Pattern Recognition (CVPR)*, July 2017.
- Deepak Babu Sam, Neeraj N. Sajjan, R. Venkatesh Babu, and Mukundhan Srinivasan. Divide and grow: Capturing huge diversity in crowd images with incrementally growing cnn. In *The IEEE Conference on Computer Vision and Pattern Recognition (CVPR)*, June 2018.
- Seung-Hwan Baek, Inchang Choi, and Min H. Kim. Multiview image completion with space structure propagation. In *The IEEE Conference on Computer Vision and Pattern Recognition (CVPR)*, June 2016.
- Seungryul Baek, Kwang In Kim, and Tae-Kyun Kim. Augmented skeleton space transfer for depth-based hand pose estimation. In *The IEEE Conference on Computer Vision and Pattern Recognition (CVPR)*, June 2018.

- Seungryul Baek, Kwang In Kim, and Tae-Kyun Kim. Pushing the envelope for rgb-based dense 3d hand pose estimation via neural rendering. In *The IEEE Conference on Computer Vision and Pattern Recognition (CVPR)*, June 2019.
- Timur Bagautdinov, Alexandre Alahi, Francois Fleuret, Pascal Fua, and Silvio Savarese. Social scene understanding: End-to-end multi-person action localization and collective activity recognition. In *The IEEE Conference on Computer Vision and Pattern Recognition (CVPR)*, July 2017.
- Timur Bagautdinov, Chenglei Wu, Jason Saragih, Pascal Fua, and Yaser Sheikh. Modeling facial geometry using compositional vaes. In *The IEEE Conference on Computer Vision and Pattern Recognition (CVPR)*, June 2018.
- Hessam Bagherinezhad, Mohammad Rastegari, and Ali Farhadi. Lcnn: Lookup-based convolutional neural network. In *The IEEE Conference on Computer Vision and Pattern Recognition (CVPR)*, July 2017.
- Song Bai, Xiang Bai, Zhichao Zhou, Zhaoxiang Zhang, and Longin Jan Latecki. Gift: A real-time and scalable 3d shape search engine. In *The IEEE Conference on Computer Vision and Pattern Recognition (CVPR)*, June 2016.
- Song Bai, Xiang Bai, and Qi Tian. Scalable person re-identification on supervised smoothed manifold. In *The IEEE Conference on Computer Vision and Pattern Recognition (CVPR)*, July 2017.
- Song Bai, Peng Tang, Philip H.S. Torr, and Longin Jan Latecki. Re-ranking via metric fusion for object retrieval and person re-identification. In *The IEEE Conference on Computer Vision and Pattern Recognition (CVPR)*, June 2019.
- Yancheng Bai, Yongqiang Zhang, Mingli Ding, and Bernard Ghanem. Finding tiny faces in the wild with generative adversarial network. In *The IEEE Conference on Computer Vision and Pattern Recognition (CVPR)*, June 2018.
- Christian Bailer, Kiran Varanasi, and Didier Stricker. Cnn-based patch matching for optical flow with thresholded hinge embedding loss. In *The IEEE Conference on Computer Vision and Pattern Recognition (CVPR)*, July 2017.
- Slawomir Bak and Peter Carr. One-shot metric learning for person re-identification. In *The IEEE Conference on Computer Vision and Pattern Recognition (CVPR)*, July 2017.
- Arun Balajee Vasudevan, Dengxin Dai, and Luc Van Gool. Object referring in videos with language and human gaze. In *The IEEE Conference on Computer Vision and Pattern Recognition (CVPR)*, June 2018.
- Guha Balakrishnan, Amy Zhao, Adrian V. Dalca, Frédo Durand, and John Guttag. Synthesizing images of humans in unseen poses. In *The IEEE Conference on Computer Vision and Pattern Recognition (CVPR)*, June 2018.
- Vassileios Balntas, Karel Lenc, Andrea Vedaldi, and Krystian Mikolajczyk. Hpatches: A benchmark and evaluation of handcrafted and learned local descriptors. In *The IEEE Conference on Computer Vision and Pattern Recognition (CVPR)*, July 2017.
- Monami Banerjee, Rudrasis Chakraborty, Edward Ofori, Michael S. Okun, David E. Viallancourt, and Baba C. Vemuri. A nonlinear regression technique for manifold valued data with applications to medical image analysis. In *The IEEE Conference on Computer Vision and Pattern Recognition (CVPR)*, June 2016.
- Aayush Bansal, Bryan Russell, and Abhinav Gupta. Marr revisited: 2d-3d alignment via surface normal prediction. In *The IEEE Conference on Computer Vision and Pattern Recognition (CVPR)*, June 2016.
- Aayush Bansal, Yaser Sheikh, and Deva Ramanan. Shapes and context: In-the-wild image synthesis manipulation. In *The IEEE Conference on Computer Vision and Pattern Recognition (CVPR)*, June 2019.

- Linchao Bao, Baoyuan Wu, and Wei Liu. Cnn in mrf: Video object segmentation via inference in a cnn-based higher-order spatio-temporal mrf. In *The IEEE Conference on Computer Vision and Pattern Recognition (CVPR)*, June 2018.
- Wenbo Bao, Wei-Sheng Lai, Chao Ma, Xiaoyun Zhang, Zhiyong Gao, and Ming-Hsuan Yang. Depth-aware video frame interpolation. In *The IEEE Conference on Computer Vision and Pattern Recognition (CVPR)*, June 2019.
- Akash Bapat and Jan-Michael Frahm. The domain transform solver. In *The IEEE Conference on Computer Vision and Pattern Recognition (CVPR)*, June 2019.
- Akash Bapat, True Price, and Jan-Michael Frahm. Rolling shutter and radial distortion are features for high frame rate multi-camera tracking. In *The IEEE Conference on Computer Vision and Pattern Recognition (CVPR)*, June 2018.
- Jawadul H. Bappy, Sujoy Paul, Ertem Tuncel, and Amit K. Roy-Chowdhury. The impact of typicality for informative representative selection. In *The IEEE Conference on Computer Vision and Pattern Recognition (CVPR)*, July 2017.
- Pierre Baque, Timur Bagautdinov, Francois Fleuret, and Pascal Fua. Principled parallel mean-field inference for discrete random fields. In *The IEEE Conference on Computer Vision and Pattern Recognition (CVPR)*, June 2016.
- Pierre Baque, Francois Fleuret, and Pascal Fua. Multi-modal mean-fields via cardinality-based clamping. In *The IEEE Conference on Computer Vision and Pattern Recognition (CVPR)*, July 2017.
- Manel Baradad, Vickie Ye, Adam B. Yedidia, Frédo Durand, William T. Freeman, Gregory W. Wornell, and Antonio Torralba. Inferring light fields from shadows. In *The IEEE Conference on Computer Vision and Pattern Recognition (CVPR)*, June 2018.
- Fabien Baradel, Christian Wolf, Julien Mille, and Graham W. Taylor. Glimpse clouds: Human activity recognition from unstructured feature points. In *The IEEE Conference on Computer Vision and Pattern Recognition (CVPR)*, June 2018.
- Lorenzo Baraldi, Costantino Grana, and Rita Cucchiara. Hierarchical boundary-aware neural encoder for video captioning. In *The IEEE Conference on Computer Vision and Pattern Recognition (CVPR)*, July 2017.
- Lorenzo Baraldi, Matthijs Douze, Rita Cucchiara, and Hervé Jégou. Lamv: Learning to align and match videos with kernelized temporal layers. In *The IEEE Conference on Computer Vision and Pattern Recognition (CVPR)*, June 2018.
- Daniel Barath. Five-point fundamental matrix estimation for uncalibrated cameras. In *The IEEE Conference on Computer Vision and Pattern Recognition (CVPR)*, June 2018.
- Daniel Barath, Tekla Toth, and Levente Hajder. A minimal solution for two-view focal-length estimation using two affine correspondences. In *The IEEE Conference on Computer Vision and Pattern Recognition (CVPR)*, July 2017.
- Daniel Barath, Jiri Matas, and Jana Noskova. Magsac: Marginalizing sample consensus. In *The IEEE Conference on Computer Vision and Pattern Recognition (CVPR)*, June 2019.
- Patrick Bardow, Andrew J. Davison, and Stefan Leutenegger. Simultaneous optical flow and intensity estimation from an event camera. In *The IEEE Conference on Computer Vision and Pattern Recognition (CVPR)*, June 2016.
- Ehud Barnea and Ohad Ben-Shahar. Curve reconstruction via the global statistics of natural curves. In *The IEEE Conference on Computer Vision and Pattern Recognition (CVPR)*, June 2018.
- Ehud Barnea and Ohad Ben-Shahar. Exploring the bounds of the utility of context for object detection. In *The IEEE Conference on Computer Vision and Pattern Recognition (CVPR)*, June 2019.

- Jonathan T. Barron. A general and adaptive robust loss function. In *The IEEE Conference on Computer Vision and Pattern Recognition (CVPR)*, June 2019.
- Jonathan T. Barron and Yun-Ta Tsai. Fast fourier color constancy. In *The IEEE Conference on Computer Vision and Pattern Recognition (CVPR)*, July 2017.
- Anil S. Baslamisli, Hoang-An Le, and Theo Gevers. Cnn based learning using reflection and retinex models for intrinsic image decomposition. In *The IEEE Conference on Computer Vision and Pattern Recognition (CVPR)*, June 2018.
- Favyen Bastani, Songtao He, Sofiane Abbar, Mohammad Alizadeh, Hari Balakrishnan, Sanjay Chawla, Sam Madden, and David DeWitt. Roadtracer: Automatic extraction of road networks from aerial images. In *The IEEE Conference on Computer Vision and Pattern Recognition (CVPR)*, June 2018.
- Anil Batra, Suriya Singh, Guan Pang, Saikat Basu, C.V. Jawahar, and Manohar Paluri. Improved road connectivity by joint learning of orientation and segmentation. In *The IEEE Conference on Computer Vision and Pattern Recognition (CVPR)*, June 2019.
- Konstantinos Batsos, Changjiang Cai, and Philippos Mordohai. CbmV: A coalesced bidirectional matching volume for disparity estimation. In *The IEEE Conference on Computer Vision and Pattern Recognition (CVPR)*, June 2018.
- David Bau, Bolei Zhou, Aditya Khosla, Aude Oliva, and Antonio Torralba. Network dissection: Quantifying interpretability of deep visual representations. In *The IEEE Conference on Computer Vision and Pattern Recognition (CVPR)*, July 2017.
- Jean-Philippe Bauchet and Florent Lafarge. Kippi: Kinetic polygonal partitioning of images. In *The IEEE Conference on Computer Vision and Pattern Recognition (CVPR)*, June 2018.
- Christian F. Baumgartner, Lisa M. Koch, Kerem Can Tezcan, Jia Xi Ang, and Ender Konukoglu. Visual feature attribution using wasserstein gans. In *The IEEE Conference on Computer Vision and Pattern Recognition (CVPR)*, June 2018.
- Miguel A. Bautista, Artsiom Sanakoyeu, and Bjorn Ommer. Deep unsupervised similarity learning using partially ordered sets. In *The IEEE Conference on Computer Vision and Pattern Recognition (CVPR)*, July 2017.
- Aseem Behl, Despoina Paschalidou, Simon Donne, and Andreas Geiger. Pointflownet: Learning representations for rigid motion estimation from point clouds. In *The IEEE Conference on Computer Vision and Pattern Recognition (CVPR)*, June 2019.
- Sean Bell, C. Lawrence Zitnick, Kavita Bala, and Ross Girshick. Inside-outside net: Detecting objects in context with skip pooling and recurrent neural networks. In *The IEEE Conference on Computer Vision and Pattern Recognition (CVPR)*, June 2016.
- William H. Beluch, Tim Genewein, Andreas Nürnberger, and Jan M. Köhler. The power of ensembles for active learning in image classification. In *The IEEE Conference on Computer Vision and Pattern Recognition (CVPR)*, June 2018.
- Gil Ben-Artzi, Yoni Kasten, Shmuel Peleg, and Michael Werman. Camera calibration from dynamic silhouettes using motion barcodes. In *The IEEE Conference on Computer Vision and Pattern Recognition (CVPR)*, June 2016.
- Yizhak Ben-Shabat, Michael Lindenbaum, and Anath Fischer. Nesti-net: Normal estimation for unstructured 3d point clouds using convolutional neural networks. In *The IEEE Conference on Computer Vision and Pattern Recognition (CVPR)*, June 2019.
- Amor Ben Tanfous, Hassen Drira, and Boulbaba Ben Amor. Coding kendall's shape trajectories for 3d action recognition. In *The IEEE Conference on Computer Vision and Pattern Recognition (CVPR)*, June 2018.
- Abhijit Bendale and Terrance E. Boult. Towards open set deep networks. In *The IEEE Conference on Computer Vision and Pattern Recognition (CVPR)*, June 2016.

- Rodrigo Benenson, Stefan Popov, and Vittorio Ferrari. Large-scale interactive object segmentation with human annotators. In *The IEEE Conference on Computer Vision and Pattern Recognition (CVPR)*, June 2019.
- Paul Bergmann, Michael Fauser, David Sattlegger, and Carsten Steger. Mvtec ad – a comprehensive real-world dataset for unsupervised anomaly detection. In *The IEEE Conference on Computer Vision and Pattern Recognition (CVPR)*, June 2019.
- Dana Berman, Tali Treibitz, and Shai Avidan. Non-local image dehazing. In *The IEEE Conference on Computer Vision and Pattern Recognition (CVPR)*, June 2016.
- Maxim Berman, Amal Rannen Triki, and Matthew B. Blaschko. The Iovász-softmax loss: A tractable surrogate for the optimization of the intersection-over-union measure in neural networks. In *The IEEE Conference on Computer Vision and Pattern Recognition (CVPR)*, June 2018.
- Florian Bernard, Peter Gemmar, Frank Hertel, Jorge Goncalves, and Johan Thunberg. Linear shape deformation models with local support using graph-based structured matrix factorisation. In *The IEEE Conference on Computer Vision and Pattern Recognition (CVPR)*, June 2016.
- Florian Bernard, Frank R. Schmidt, Johan Thunberg, and Daniel Cremers. A combinatorial solution to non-rigid 3d shape-to-image matching. In *The IEEE Conference on Computer Vision and Pattern Recognition (CVPR)*, July 2017.
- Florian Bernard, Christian Theobalt, and Michael Moeller. Ds*: Tighter lifting-free convex relaxations for quadratic matching problems. In *The IEEE Conference on Computer Vision and Pattern Recognition (CVPR)*, June 2018.
- Gedas Bertasius, Jianbo Shi, and Lorenzo Torresani. Semantic segmentation with boundary neural fields. In *The IEEE Conference on Computer Vision and Pattern Recognition (CVPR)*, June 2016.
- Gedas Bertasius, Lorenzo Torresani, Stella X. Yu, and Jianbo Shi. Convolutional random walk networks for semantic image segmentation. In *The IEEE Conference on Computer Vision and Pattern Recognition (CVPR)*, July 2017.
- Gedas Bertasius, Aaron Chan, and Jianbo Shi. Egocentric basketball motion planning from a single first-person image. In *The IEEE Conference on Computer Vision and Pattern Recognition (CVPR)*, June 2018.
- Luca Bertinetto, Jack Valmadre, Stuart Golodetz, Ondrej Miksik, and Philip H. S. Torr. Staple: Complementary learners for real-time tracking. In *The IEEE Conference on Computer Vision and Pattern Recognition (CVPR)*, June 2016.
- Shweta Bhardwaj, Mukundhan Srinivasan, and Mitesh M. Khapra. Efficient video classification using fewer frames. In *The IEEE Conference on Computer Vision and Pattern Recognition (CVPR)*, June 2019.
- Apratim Bhattacharyya, Mario Fritz, and Bernt Schiele. Long-term on-board prediction of people in traffic scenes under uncertainty. In *The IEEE Conference on Computer Vision and Pattern Recognition (CVPR)*, June 2018.
- Binod Bhattarai, Gaurav Sharma, and Frederic Jurie. Cp-mtml: Coupled projection multi-task metric learning for large scale face retrieval. In *The IEEE Conference on Computer Vision and Pattern Recognition (CVPR)*, June 2016.
- Ayan Kumar Bhunia, Abhirup Das, Ankan Kumar Bhunia, Perla Sai Raj Kishore, and Partha Pratim Roy. Handwriting recognition in low-resource scripts using adversarial learning. In *The IEEE Conference on Computer Vision and Pattern Recognition (CVPR)*, June 2019.
- JiaWang Bian, Wen-Yan Lin, Yasuyuki Matsushita, Sai-Kit Yeung, Tan-Dat Nguyen, and Ming-Ming Cheng. Gms: Grid-based motion statistics for fast, ultra-robust feature correspondence. In *The IEEE Conference on Computer Vision and Pattern Recognition (CVPR)*, July 2017.
- Simone Bianco and Claudio Cusano. Quasi-unsupervised color constancy. In *The IEEE Conference on Computer Vision and Pattern Recognition (CVPR)*, June 2019.

- Adel Bibi, Tianzhu Zhang, and Bernard Ghanem. 3d part-based sparse tracker with automatic synchronization and registration. In *The IEEE Conference on Computer Vision and Pattern Recognition (CVPR)*, June 2016.
- Adel Bibi, Hani Itani, and Bernard Ghanem. Fftlasso: Large-scale lasso in the fourier domain. In *The IEEE Conference on Computer Vision and Pattern Recognition (CVPR)*, July 2017.
- Adel Bibi, Modar Alfadly, and Bernard Ghanem. Analytic expressions for probabilistic moments of pl-dnn with gaussian input. In *The IEEE Conference on Computer Vision and Pattern Recognition (CVPR)*, June 2018.
- Pia Bideau, Aruni RoyChowdhury, Rakesh R. Menon, and Erik Learned-Miller. The best of both worlds: Combining cnns and geometric constraints for hierarchical motion segmentation. In *The IEEE Conference on Computer Vision and Pattern Recognition (CVPR)*, June 2018.
- Hakan Bilen and Andrea Vedaldi. Weakly supervised deep detection networks. In *The IEEE Conference on Computer Vision and Pattern Recognition (CVPR)*, June 2016.
- Piotr Bilinski and Victor Prisacariu. Dense decoder shortcut connections for single-pass semantic segmentation. In *The IEEE Conference on Computer Vision and Pattern Recognition (CVPR)*, June 2018.
- Tolga Birdal and Umut Simsekli. Probabilistic permutation synchronization using the riemannian structure of the birkhoff polytope. In *The IEEE Conference on Computer Vision and Pattern Recognition (CVPR)*, June 2019.
- Tolga Birdal, Benjamin Busam, Nassir Navab, Slobodan Ilic, and Peter Sturm. A minimalist approach to type-agnostic detection of quadrics in point clouds. In *The IEEE Conference on Computer Vision and Pattern Recognition (CVPR)*, June 2018.
- Ali Furkan Biten, Lluís Gomez, Marçal Rusinol, and Dimosthenis Karatzas. Good news, everyone! context driven entity-aware captioning for news images. In *The IEEE Conference on Computer Vision and Pattern Recognition (CVPR)*, June 2019.
- Maros Blaha, Christoph Vogel, Audrey Richard, Jan D. Wegner, Thomas Pock, and Konrad Schindler. Large-scale semantic 3d reconstruction: An adaptive multi-resolution model for multi-class volumetric labeling. In *The IEEE Conference on Computer Vision and Pattern Recognition (CVPR)*, June 2016.
- Nathaniel Blanchard, Jeffery Kinnison, Brandon RichardWebster, Pouya Bashivan, and Walter J. Scheirer. A neurobiological evaluation metric for neural network model search. In *The IEEE Conference on Computer Vision and Pattern Recognition (CVPR)*, June 2019.
- Henryk Blasinski, Joyce Farrell, and Brian Wandell. Designing illuminant spectral power distributions for surface classification. In *The IEEE Conference on Computer Vision and Pattern Recognition (CVPR)*, July 2017.
- Yochai Blau and Tomer Michaeli. The perception-distortion tradeoff. In *The IEEE Conference on Computer Vision and Pattern Recognition (CVPR)*, June 2018.
- Michael Bloesch, Jan Czarnowski, Ronald Clark, Stefan Leutenegger, and Andrew J. Davison. Codeslam — learning a compact, optimisable representation for dense visual slam. In *The IEEE Conference on Computer Vision and Pattern Recognition (CVPR)*, June 2018.
- Federica Bogo, Javier Romero, Gerard Pons-Moll, and Michael J. Black. Dynamic faust: Registering human bodies in motion. In *The IEEE Conference on Computer Vision and Pattern Recognition (CVPR)*, July 2017.
- Timo Bolkart and Stefanie Wuhrer. A robust multilinear model learning framework for 3d faces. In *The IEEE Conference on Computer Vision and Pattern Recognition (CVPR)*, June 2016.
- James Booth, Anastasios Roussos, Stefanos Zafeiriou, Allan Ponniah, and David Dunaway. A 3d morphable model learnt from 10,000 faces. In *The IEEE Conference on Computer Vision and Pattern Recognition (CVPR)*, June 2016.

- James Booth, Epameinondas Antonakos, Stylianos Ploumpis, George Trigeorgis, Yannis Panagakis, and Stefanos Zafeiriou. 3d face morphable models "in-the-wild". In *The IEEE Conference on Computer Vision and Pattern Recognition (CVPR)*, July 2017.
- Guido Borghi, Marco Venturelli, Roberto Vezzani, and Rita Cucchiara. Poseidon: Face-from-depth for driver pose estimation. In *The IEEE Conference on Computer Vision and Pattern Recognition (CVPR)*, July 2017.
- Ali Borji, Saeed Izadi, and Laurent Itti. ilab-20m: A large-scale controlled object dataset to investigate deep learning. In *The IEEE Conference on Computer Vision and Pattern Recognition (CVPR)*, June 2016.
- Adnane Boukhayma, Jean-Sebastien Franco, and Edmond Boyer. Surface motion capture transfer with gaussian process regression. In *The IEEE Conference on Computer Vision and Pattern Recognition (CVPR)*, July 2017.
- Adnane Boukhayma, Rodrigo de Bem, and Philip H.S. Torr. 3d hand shape and pose from images in the wild. In *The IEEE Conference on Computer Vision and Pattern Recognition (CVPR)*, June 2019.
- Katherine L. Bouman, Michael D. Johnson, Daniel Zoran, Vincent L. Fish, Sheperd S. Doleman, and William T. Freeman. Computational imaging for vlbi image reconstruction. In *The IEEE Conference on Computer Vision and Pattern Recognition (CVPR)*, June 2016.
- Giorgos Bouritsas, Petros Koutras, Athanasia Zlatintsi, and Petros Maragos. Multimodal visual concept learning with weakly supervised techniques. In *The IEEE Conference on Computer Vision and Pattern Recognition (CVPR)*, June 2018.
- Konstantinos Bousmalis, Nathan Silberman, David Dohan, Dumitru Erhan, and Dilip Krishnan. Unsupervised pixel-level domain adaptation with generative adversarial networks. In *The IEEE Conference on Computer Vision and Pattern Recognition (CVPR)*, July 2017.
- Katarzyna Bozek, Laetitia Hebert, Alexander S. Mikheyev, and Greg J. Stephens. Towards dense object tracking in a 2d honeybee hive. In *The IEEE Conference on Computer Vision and Pattern Recognition (CVPR)*, June 2018.
- Lior Bracha and Gal Chechik. Informative object annotations: Tell me something i don't know. In *The IEEE Conference on Computer Vision and Pattern Recognition (CVPR)*, June 2019.
- Eric Brachmann and Carsten Rother. Learning less is more - 6d camera localization via 3d surface regression. In *The IEEE Conference on Computer Vision and Pattern Recognition (CVPR)*, June 2018.
- Eric Brachmann, Frank Michel, Alexander Krull, Michael Ying Yang, Stefan Gumhold, and carsten Rother. Uncertainty-driven 6d pose estimation of objects and scenes from a single rgb image. In *The IEEE Conference on Computer Vision and Pattern Recognition (CVPR)*, June 2016.
- Eric Brachmann, Alexander Krull, Sebastian Nowozin, Jamie Shotton, Frank Michel, Stefan Gumhold, and Carsten Rother. Dsac - differentiable ransac for camera localization. In *The IEEE Conference on Computer Vision and Pattern Recognition (CVPR)*, July 2017.
- Samarth Brahmabhatt and James Hays. Deepnav: Learning to navigate large cities. In *The IEEE Conference on Computer Vision and Pattern Recognition (CVPR)*, July 2017.
- Samarth Brahmabhatt, Jinwei Gu, Kihwan Kim, James Hays, and Jan Kautz. Geometry-aware learning of maps for camera localization. In *The IEEE Conference on Computer Vision and Pattern Recognition (CVPR)*, June 2018.
- Samarth Brahmabhatt, Cusuh Ham, Charles C. Kemp, and James Hays. Contactdb: Analyzing and predicting grasp contact via thermal imaging. In *The IEEE Conference on Computer Vision and Pattern Recognition (CVPR)*, June 2019.

- Frederic Branchaud-Charron, Andrew Achkar, and Pierre-Marc Jodoin. Spectral metric for dataset complexity assessment. In *The IEEE Conference on Computer Vision and Pattern Recognition (CVPR)*, June 2019.
- Steve Branson, Grant Van Horn, and Pietro Perona. Lean crowdsourcing: Combining humans and machines in an online system. In *The IEEE Conference on Computer Vision and Pattern Recognition (CVPR)*, July 2017.
- Biagio Brattoli, Uta Buchler, Anna-Sophia Wahl, Martin E. Schwab, and Bjorn Ommer. Lstm self-supervision for detailed behavior analysis. In *The IEEE Conference on Computer Vision and Pattern Recognition (CVPR)*, July 2017.
- Garrick Brazil and Xiaoming Liu. Pedestrian detection with autoregressive network phases. In *The IEEE Conference on Computer Vision and Pattern Recognition (CVPR)*, June 2019.
- Jesus Briales and Javier Gonzalez-Jimenez. Convex global 3d registration with lagrangian duality. In *The IEEE Conference on Computer Vision and Pattern Recognition (CVPR)*, July 2017.
- Jesus Briales, Laurent Kneip, and Javier Gonzalez-Jimenez. A certifiably globally optimal solution to the non-minimal relative pose problem. In *The IEEE Conference on Computer Vision and Pattern Recognition (CVPR)*, June 2018.
- Tim Brooks and Jonathan T. Barron. Learning to synthesize motion blur. In *The IEEE Conference on Computer Vision and Pattern Recognition (CVPR)*, June 2019.
- Sofia Broome, Karina Bech Gleeurup, Pia Haubro Andersen, and Hedvig Kjellstrom. Dynamics are important for the recognition of equine pain in video. In *The IEEE Conference on Computer Vision and Pattern Recognition (CVPR)*, June 2019.
- Neil D. B. Bruce, Christopher Catton, and Sasa Janjic. A deeper look at saliency: Feature contrast, semantics, and beyond. In *The IEEE Conference on Computer Vision and Pattern Recognition (CVPR)*, June 2016.
- Shyamal Buch, Victor Escorcia, Chuanqi Shen, Bernard Ghanem, and Juan Carlos Niebles. Sst: Single-stream temporal action proposals. In *The IEEE Conference on Computer Vision and Pattern Recognition (CVPR)*, July 2017.
- Adrian Bulat and Georgios Tzimiropoulos. Super-fan: Integrated facial landmark localization and super-resolution of real-world low resolution faces in arbitrary poses with gans. In *The IEEE Conference on Computer Vision and Pattern Recognition (CVPR)*, June 2018.
- Philippe Burlina, Neil Joshi, and I-Jeng Wang. Where's wally now? deep generative and discriminative embeddings for novelty detection. In *The IEEE Conference on Computer Vision and Pattern Recognition (CVPR)*, June 2019.
- Andrey Bushnevskiy, Lorenzo Sorigi, and Bodo Rosenhahn. Multicamera calibration from visible and mirrored epipoles. In *The IEEE Conference on Computer Vision and Pattern Recognition (CVPR)*, June 2016.
- Judith Butepage, Michael J. Black, Danica Kragic, and Hedvig Kjellstrom. Deep representation learning for human motion prediction and classification. In *The IEEE Conference on Computer Vision and Pattern Recognition (CVPR)*, July 2017.
- Erik Bylow, Carl Olsson, Fredrik Kahl, and Mikael Nilsson. Minimizing the maximal rank. In *The IEEE Conference on Computer Vision and Pattern Recognition (CVPR)*, June 2016.
- Fabian Caba Heilbron, Juan Carlos Niebles, and Bernard Ghanem. Fast temporal activity proposals for efficient detection of human actions in untrimmed videos. In *The IEEE Conference on Computer Vision and Pattern Recognition (CVPR)*, June 2016.
- Fabian Caba Heilbron, Wayner Barrios, Victor Escorcia, and Bernard Ghanem. Scc: Semantic context cascade for efficient action detection. In *The IEEE Conference on Computer Vision and Pattern Recognition (CVPR)*, July 2017.

- Jose Caballero, Christian Ledig, Andrew Aitken, Alejandro Acosta, Johannes Totz, Zehan Wang, and Wenzhe Shi. Real-time video super-resolution with spatio-temporal networks and motion compensation. In *The IEEE Conference on Computer Vision and Pattern Recognition (CVPR)*, July 2017.
- Remi Cadene, Hedi Ben-younes, Matthieu Cord, and Nicolas Thome. Murel: Multimodal relational reasoning for visual question answering. In *The IEEE Conference on Computer Vision and Pattern Recognition (CVPR)*, June 2019.
- Sergi Caelles, Kevis-Kokitsi Maninis, Jordi Pont-Tuset, Laura Leal-Taixe, Daniel Cremers, and Luc Van Gool. One-shot video object segmentation. In *The IEEE Conference on Computer Vision and Pattern Recognition (CVPR)*, July 2017.
- Holger Caesar, Jasper Uijlings, and Vittorio Ferrari. Coco-stuff: Thing and stuff classes in context. In *The IEEE Conference on Computer Vision and Pattern Recognition (CVPR)*, June 2018.
- Nathan D. Cahill, Tyler L. Hayes, Renee T. Meinhold, and John F. Hamilton. Compassionately conservative balanced cuts for image segmentation. In *The IEEE Conference on Computer Vision and Pattern Recognition (CVPR)*, June 2018.
- Lile Cai, Bin Zhao, Zhe Wang, Jie Lin, Chuan Sheng Foo, Mohamed Sabry Aly, and Vijay Chandrasekhar. Maxpoolnms: Getting rid of nms bottlenecks in two-stage object detectors. In *The IEEE Conference on Computer Vision and Pattern Recognition (CVPR)*, June 2019.
- Qi Cai, Yingwei Pan, Ting Yao, Chenggang Yan, and Tao Mei. Memory matching networks for one-shot image recognition. In *The IEEE Conference on Computer Vision and Pattern Recognition (CVPR)*, June 2018.
- Sijia Cai, Lei Zhang, Wangmeng Zuo, and Xiangchu Feng. A probabilistic collaborative representation based approach for pattern classification. In *The IEEE Conference on Computer Vision and Pattern Recognition (CVPR)*, June 2016.
- Zhaowei Cai, Xiaodong He, Jian Sun, and Nuno Vasconcelos. Deep learning with low precision by half-wave gaussian quantization. In *The IEEE Conference on Computer Vision and Pattern Recognition (CVPR)*, July 2017.
- Juan C. Caicedo, Claire McQuin, Allen Goodman, Shantanu Singh, and Anne E. Carpenter. Weakly supervised learning of single-cell feature embeddings. In *The IEEE Conference on Computer Vision and Pattern Recognition (CVPR)*, June 2018.
- Fatih Cakir, Kun He, Xide Xia, Brian Kulis, and Stan Sclaroff. Deep metric learning to rank. In *The IEEE Conference on Computer Vision and Pattern Recognition (CVPR)*, June 2019.
- Lilian Calvet, Pierre Gurdjos, Carsten Griwodz, and Simone Gasparini. Detection and accurate localization of circular fiducials under highly challenging conditions. In *The IEEE Conference on Computer Vision and Pattern Recognition (CVPR)*, June 2016.
- Dylan Campbell and Lars Petersson. Gogma: Globally-optimal gaussian mixture alignment. In *The IEEE Conference on Computer Vision and Pattern Recognition (CVPR)*, June 2016.
- Dylan Campbell, Lars Petersson, Laurent Kneip, Hongdong Li, and Stephen Gould. The alignment of the spheres: Globally-optimal spherical mixture alignment for camera pose estimation. In *The IEEE Conference on Computer Vision and Pattern Recognition (CVPR)*, June 2019.
- Federico Camposeco, Torsten Sattler, Andrea Cohen, Andreas Geiger, and Marc Pollefeys. Toroidal constraints for two-point localization under high outlier ratios. In *The IEEE Conference on Computer Vision and Pattern Recognition (CVPR)*, July 2017.
- Federico Camposeco, Andrea Cohen, Marc Pollefeys, and Torsten Sattler. Hybrid camera pose estimation. In *The IEEE Conference on Computer Vision and Pattern Recognition (CVPR)*, June 2018.

- Federico Camposeco, Andrea Cohen, Marc Pollefeys, and Torsten Sattler. Hybrid scene compression for visual localization. In *The IEEE Conference on Computer Vision and Pattern Recognition (CVPR)*, June 2019.
- Hakki Can Karaimer and Michael S. Brown. Improving color reproduction accuracy on cameras. In *The IEEE Conference on Computer Vision and Pattern Recognition (CVPR)*, June 2018.
- Olivier Canevet and Francois Fleuret. Large scale hard sample mining with monte carlo tree search. In *The IEEE Conference on Computer Vision and Pattern Recognition (CVPR)*, June 2016.
- Jiale Cao, Yanwei Pang, and Xuelong Li. Pedestrian detection inspired by appearance constancy and shape symmetry. In *The IEEE Conference on Computer Vision and Pattern Recognition (CVPR)*, June 2016.
- Qingxing Cao, Liang Lin, Yukai Shi, Xiaodan Liang, and Guanbin Li. Attention-aware face hallucination via deep reinforcement learning. In *The IEEE Conference on Computer Vision and Pattern Recognition (CVPR)*, July 2017.
- Yue Cao, Mingsheng Long, Bin Liu, and Jianmin Wang. Deep cauchy hashing for hamming space retrieval. In *The IEEE Conference on Computer Vision and Pattern Recognition (CVPR)*, June 2018.
- Zhangjie Cao, Kaichao You, Mingsheng Long, Jianmin Wang, and Qiang Yang. Learning to transfer examples for partial domain adaptation. In *The IEEE Conference on Computer Vision and Pattern Recognition (CVPR)*, June 2019.
- Fabio M. Carlucci, Antonio D’Innocente, Silvia Bucci, Barbara Caputo, and Tatiana Tommasi. Domain generalization by solving jigsaw puzzles. In *The IEEE Conference on Computer Vision and Pattern Recognition (CVPR)*, June 2019.
- Joao Carreira and Andrew Zisserman. Quo vadis, action recognition? a new model and the kinetics dataset. In *The IEEE Conference on Computer Vision and Pattern Recognition (CVPR)*, July 2017.
- Joao Carreira, Pulkit Agrawal, Katerina Fragkiadaki, and Jitendra Malik. Human pose estimation with iterative error feedback. In *The IEEE Conference on Computer Vision and Pattern Recognition (CVPR)*, June 2016.
- Lluís Castrejon, Yusuf Aytar, Carl Vondrick, Hamed Pirsiavash, and Antonio Torralba. Learning aligned cross-modal representations from weakly aligned data. In *The IEEE Conference on Computer Vision and Pattern Recognition (CVPR)*, June 2016.
- Lluís Castrejon, Kaustav Kundu, Raquel Urtasun, and Sanja Fidler. Annotating object instances with a polygon-rnn. In *The IEEE Conference on Computer Vision and Pattern Recognition (CVPR)*, July 2017.
- Tommaso Cavallari, Stuart Golodetz, Nicholas A. Lord, Julien Valentin, Luigi Di Stefano, and Philip H. S. Torr. On-the-fly adaptation of regression forests for online camera relocalisation. In *The IEEE Conference on Computer Vision and Pattern Recognition (CVPR)*, July 2017.
- Lorenzo Cerrone, Alexander Zeilmann, and Fred A. Hamprecht. End-to-end learned random walker for seeded image segmentation. In *The IEEE Conference on Computer Vision and Pattern Recognition (CVPR)*, June 2019.
- Hakan Cevikalp and Bill Triggs. Polyhedral conic classifiers for visual object detection and classification. In *The IEEE Conference on Computer Vision and Pattern Recognition (CVPR)*, July 2017.
- Florian Chabot, Mohamed Chaouch, Jaonary Rabarisoa, Celine Teuliere, and Thierry Chateau. Deep manta: A coarse-to-fine many-task network for joint 2d and 3d vehicle analysis from monocular image. In *The IEEE Conference on Computer Vision and Pattern Recognition (CVPR)*, July 2017.

- Rohan Chabra, Julian Straub, Christopher Sweeney, Richard Newcombe, and Henry Fuchs. Stereodnet: Dilated residual stereonet. In *The IEEE Conference on Computer Vision and Pattern Recognition (CVPR)*, June 2019.
- Rudrasis Chakraborty, Dohyung Seo, and Baba C. Vemuri. An efficient exact-pga algorithm for constant curvature manifolds. In *The IEEE Conference on Computer Vision and Pattern Recognition (CVPR)*, June 2016.
- Rudrasis Chakraborty, Soren Hauberg, and Baba C. Vemuri. Intrinsic grassmann averages for online linear and robust subspace learning. In *The IEEE Conference on Computer Vision and Pattern Recognition (CVPR)*, July 2017.
- Jacob Chan, Jimmy Addison Lee, and Qian Kemao. Border: An oriented rectangles approach to texture-less object recognition. In *The IEEE Conference on Computer Vision and Pattern Recognition (CVPR)*, June 2016.
- Jacob Chan, Jimmy Addison Lee, and Qian Kemao. Bind: Binary integrated net descriptors for texture-less object recognition. In *The IEEE Conference on Computer Vision and Pattern Recognition (CVPR)*, July 2017.
- Rohan Chandra, Uttaran Bhattacharya, Aniket Bera, and Dinesh Manocha. Taphic: Trajectory prediction in dense and heterogeneous traffic using weighted interactions. In *The IEEE Conference on Computer Vision and Pattern Recognition (CVPR)*, June 2019.
- Siddhartha Chandra, Camille Couprie, and Iasonas Kokkinos. Deep spatio-temporal random fields for efficient video segmentation. In *The IEEE Conference on Computer Vision and Pattern Recognition (CVPR)*, June 2018.
- Arjun Chandrasekaran, Ashwin K. Vijayakumar, Stanislaw Antol, Mohit Bansal, Dhruv Batra, C. Lawrence Zitnick, and Devi Parikh. We are humor beings: Understanding and predicting visual humor. In *The IEEE Conference on Computer Vision and Pattern Recognition (CVPR)*, June 2016.
- Che-Han Chang, Chun-Nan Chou, and Edward Y. Chang. Clkn: Cascaded lucas-kanade networks for image alignment. In *The IEEE Conference on Computer Vision and Pattern Recognition (CVPR)*, July 2017.
- Huiwen Chang, Jingwan Lu, Fisher Yu, and Adam Finkelstein. Pairedcyclegan: Asymmetric style transfer for applying and removing makeup. In *The IEEE Conference on Computer Vision and Pattern Recognition (CVPR)*, June 2018.
- Wei-Lun Chang, Hui-Po Wang, Wen-Hsiao Peng, and Wei-Chen Chiu. All about structure: Adapting structural information across domains for boosting semantic segmentation. In *The IEEE Conference on Computer Vision and Pattern Recognition (CVPR)*, June 2019.
- Xiaojun Chang, Yao-Liang Yu, Yi Yang, and Eric P. Xing. They are not equally reliable: Semantic event search using differentiated concept classifiers. In *The IEEE Conference on Computer Vision and Pattern Recognition (CVPR)*, June 2016.
- Soravit Changpinyo, Wei-Lun Chao, Boqing Gong, and Fei Sha. Synthesized classifiers for zero-shot learning. In *The IEEE Conference on Computer Vision and Pattern Recognition (CVPR)*, June 2016.
- Yu-Wei Chao, Jimei Yang, Brian Price, Scott Cohen, and Jia Deng. Forecasting human dynamics from static images. In *The IEEE Conference on Computer Vision and Pattern Recognition (CVPR)*, July 2017.
- Yu-Wei Chao, Sudheendra Vijayanarasimhan, Bryan Seybold, David A. Ross, Jia Deng, and Rahul Sukthankar. Rethinking the faster r-cnn architecture for temporal action localization. In *The IEEE Conference on Computer Vision and Pattern Recognition (CVPR)*, June 2018.
- James Charles, Tomas Pfister, Derek Magee, David Hogg, and Andrew Zisserman. Personalizing human video pose estimation. In *The IEEE Conference on Computer Vision and Pattern Recognition (CVPR)*, June 2016.

- Prithvijit Chattopadhyay, Ramakrishna Vedantam, Ramprasaath R. Selvaraju, Dhruv Batra, and Devi Parikh. Counting everyday objects in everyday scenes. In *The IEEE Conference on Computer Vision and Pattern Recognition (CVPR)*, July 2017.
- Bindita Chaudhuri, Noranart Vesdapunt, and Baoyuan Wang. Joint face detection and facial motion retargeting for multiple faces. In *The IEEE Conference on Computer Vision and Pattern Recognition (CVPR)*, June 2019.
- Neelima Chavali, Harsh Agrawal, Aroma Mahendru, and Dhruv Batra. Object-proposal evaluation protocol is 'gameable'. In *The IEEE Conference on Computer Vision and Pattern Recognition (CVPR)*, June 2016.
- Tatjana Chavdarova, Pierre Baqué, Stéphane Bouquet, Andrii Maksai, Cijo Jose, Timur Bagautdinov, Louis Lettry, Pascal Fua, Luc Van Gool, and François Fleuret. Wildtrack: A multi-camera hd dataset for dense unscripted pedestrian detection. In *The IEEE Conference on Computer Vision and Pattern Recognition (CVPR)*, June 2018.
- Da Chen, Jean-Marie Mirebeau, and Laurent D. Cohen. A new finsler minimal path model with curvature penalization for image segmentation and closed contour detection. In *The IEEE Conference on Computer Vision and Pattern Recognition (CVPR)*, June 2016.
- Long Chen, Hanwang Zhang, Jun Xiao, Wei Liu, and Shih-Fu Chang. Zero-shot visual recognition using semantics-preserving adversarial embedding networks. In *The IEEE Conference on Computer Vision and Pattern Recognition (CVPR)*, June 2018.
- Weihua Chen, Xiaotang Chen, Jianguo Zhang, and Kaiqi Huang. Beyond triplet loss: A deep quadruplet network for person re-identification. In *The IEEE Conference on Computer Vision and Pattern Recognition (CVPR)*, July 2017.
- Yunpeng Chen, Marcus Rohrbach, Zhicheng Yan, Yan Shuicheng, Jiashi Feng, and Yannis Kalantidis. Graph-based global reasoning networks. In *The IEEE Conference on Computer Vision and Pattern Recognition (CVPR)*, June 2019.
- Dongliang Cheng, Abdelrahman Abdelhamed, Brian Price, Scott Cohen, and Michael S. Brown. Two illuminant estimation and user correction preference. In *The IEEE Conference on Computer Vision and Pattern Recognition (CVPR)*, June 2016.
- Hao Cheng, Dongze Lian, Bowen Deng, Shenghua Gao, Tao Tan, and Yanlin Geng. Local to global learning: Gradually adding classes for training deep neural networks. In *The IEEE Conference on Computer Vision and Pattern Recognition (CVPR)*, June 2019.
- Lechao Cheng, Chengyi Zhang, and Zicheng Liao. Intrinsic image transformation via scale space decomposition. In *The IEEE Conference on Computer Vision and Pattern Recognition (CVPR)*, June 2018.
- Yanhua Cheng, Rui Cai, Zhiwei Li, Xin Zhao, and Kaiqi Huang. Locality-sensitive deconvolution networks with gated fusion for rgb-d indoor semantic segmentation. In *The IEEE Conference on Computer Vision and Pattern Recognition (CVPR)*, July 2017.
- Anoop Cherian, Basura Fernando, Mehrtash Harandi, and Stephen Gould. Generalized rank pooling for activity recognition. In *The IEEE Conference on Computer Vision and Pattern Recognition (CVPR)*, July 2017.
- Anoop Cherian, Suvrit Sra, Stephen Gould, and Richard Hartley. Non-linear temporal subspace representations for activity recognition. In *The IEEE Conference on Computer Vision and Pattern Recognition (CVPR)*, June 2018.
- Ajad Chhatkuli, Daniel Pizarro, Toby Collins, and Adrien Bartoli. Inextensible non-rigid shape-from-motion by second-order cone programming. In *The IEEE Conference on Computer Vision and Pattern Recognition (CVPR)*, June 2016.
- Tat-Jun Chin, Yang Heng Kee, Anders Eriksson, and Frank Neumann. Guaranteed outlier removal with mixed integer linear programs. In *The IEEE Conference on Computer Vision and Pattern Recognition (CVPR)*, June 2016.

- Wonwoong Cho, Sungha Choi, David Keetae Park, Inkyu Shin, and Jaegul Choo. Image-to-image translation via group-wise deep whitening-and-coloring transformation. In *The IEEE Conference on Computer Vision and Pattern Recognition (CVPR)*, June 2019.
- Yeong-Jun Cho and Kuk-Jin Yoon. Improving person re-identification via pose-aware multi-shot matching. In *The IEEE Conference on Computer Vision and Pattern Recognition (CVPR)*, June 2016.
- Gyeongmin Choe, Srinivasa G. Narasimhan, and In So Kweon. Simultaneous estimation of near ir brdf and fine-scale surface geometry. In *The IEEE Conference on Computer Vision and Pattern Recognition (CVPR)*, June 2016.
- Junsuk Choe and Hyunjung Shim. Attention-based dropout layer for weakly supervised object localization. In *The IEEE Conference on Computer Vision and Pattern Recognition (CVPR)*, June 2019.
- Jinsoo Choi, Tae-Hyun Oh, and In So Kweon. Video-story composition via plot analysis. In *The IEEE Conference on Computer Vision and Pattern Recognition (CVPR)*, June 2016.
- Jongwon Choi, Hyung Jin Chang, Sangdoon Yun, Tobias Fischer, Yiannis Demiris, and Jin Young Choi. Attentional correlation filter network for adaptive visual tracking. In *The IEEE Conference on Computer Vision and Pattern Recognition (CVPR)*, July 2017.
- Jongwon Choi, Hyung Jin Chang, Tobias Fischer, Sangdoon Yun, Kyuewang Lee, Jiyeoup Jeong, Yiannis Demiris, and Jin Young Choi. Context-aware deep feature compression for high-speed visual tracking. In *The IEEE Conference on Computer Vision and Pattern Recognition (CVPR)*, June 2018.
- Hisham Cholakkal, Jubin Johnson, and Deepu Rajan. Backtracking scspm image classifier for weakly supervised top-down saliency. In *The IEEE Conference on Computer Vision and Pattern Recognition (CVPR)*, June 2016.
- Hisham Cholakkal, Guolei Sun, Fahad Shahbaz Khan, and Ling Shao. Object counting and instance segmentation with image-level supervision. In *The IEEE Conference on Computer Vision and Pattern Recognition (CVPR)*, June 2019.
- Francois Chollet. Xception: Deep learning with depthwise separable convolutions. In *The IEEE Conference on Computer Vision and Pattern Recognition (CVPR)*, July 2017.
- Vasileios Choutas, Philippe Weinzaepfel, Jérôme Revaud, and Cordelia Schmid. Potion: Pose motion representation for action recognition. In *The IEEE Conference on Computer Vision and Pattern Recognition (CVPR)*, June 2018.
- Christopher Choy, JunYoung Gwak, and Silvio Savarese. 4d spatio-temporal convnets: Minkowski convolutional neural networks. In *The IEEE Conference on Computer Vision and Pattern Recognition (CVPR)*, June 2019.
- Gordon Christie, Neil Fendley, James Wilson, and Ryan Mukherjee. Functional map of the world. In *The IEEE Conference on Computer Vision and Pattern Recognition (CVPR)*, June 2018.
- Hang Chu, Wei-Chiu Ma, Kaustav Kundu, Raquel Urtasun, and Sanja Fidler. Surfconv: Bridging 3d and 2d convolution for rgb images. In *The IEEE Conference on Computer Vision and Pattern Recognition (CVPR)*, June 2018.
- Wen-Hsuan Chu, Yu-Jhe Li, Jing-Cheng Chang, and Yu-Chiang Frank Wang. Spot and learn: A maximum-entropy patch sampler for few-shot image classification. In *The IEEE Conference on Computer Vision and Pattern Recognition (CVPR)*, June 2019.
- Xiao Chu, Wanli Ouyang, Hongsheng Li, and Xiaogang Wang. Structured feature learning for pose estimation. In *The IEEE Conference on Computer Vision and Pattern Recognition (CVPR)*, June 2016.

- Xiao Chu, Wei Yang, Wanli Ouyang, Cheng Ma, Alan L. Yuille, and Xiaogang Wang. Multi-context attention for human pose estimation. In *The IEEE Conference on Computer Vision and Pattern Recognition (CVPR)*, July 2017.
- Ching-Yao Chuang, Jiaman Li, Antonio Torralba, and Sanja Fidler. Learning to act properly: Predicting and explaining affordances from images. In *The IEEE Conference on Computer Vision and Pattern Recognition (CVPR)*, June 2018.
- Cesc Chunseong Park, Byeongchang Kim, and Gunhee Kim. Attend to you: Personalized image captioning with context sequence memory networks. In *The IEEE Conference on Computer Vision and Pattern Recognition (CVPR)*, July 2017.
- Necati Cihan Camgoz, Simon Hadfield, Oscar Koller, Hermann Ney, and Richard Bowden. Neural sign language translation. In *The IEEE Conference on Computer Vision and Pattern Recognition (CVPR)*, June 2018.
- Ronald Clark, Sen Wang, Andrew Markham, Niki Trigoni, and Hongkai Wen. Vidloc: A deep spatio-temporal model for 6-dof video-clip relocalization. In *The IEEE Conference on Computer Vision and Pattern Recognition (CVPR)*, July 2017.
- Gad Cohen and Daphna Weinshall. Hidden layers in perceptual learning. In *The IEEE Conference on Computer Vision and Pattern Recognition (CVPR)*, July 2017.
- Nadav Cohen, Or Sharir, and Amnon Shashua. Deep simnets. In *The IEEE Conference on Computer Vision and Pattern Recognition (CVPR)*, June 2016.
- Forrester Cole, David Belanger, Dilip Krishnan, Aaron Sarna, Inbar Mosseri, and William T. Freeman. Synthesizing normalized faces from facial identity features. In *The IEEE Conference on Computer Vision and Pattern Recognition (CVPR)*, July 2017.
- John Collomosse, Tu Bui, and Hailin Jin. Livesketch: Query perturbations for guided sketch-based visual search. In *The IEEE Conference on Computer Vision and Pattern Recognition (CVPR)*, June 2019.
- Marius Cordts, Mohamed Omran, Sebastian Ramos, Timo Rehfeld, Markus Enzweiler, Rodrigo Benenson, Uwe Franke, Stefan Roth, and Bernt Schiele. The cityscapes dataset for semantic urban scene understanding. In *The IEEE Conference on Computer Vision and Pattern Recognition (CVPR)*, June 2016.
- Ciprian A. Corneanu, Meysam Madadi, Sergio Escalera, and Aleix M. Martinez. What does it mean to learn in deep networks? and, how does one detect adversarial attacks? In *The IEEE Conference on Computer Vision and Pattern Recognition (CVPR)*, June 2019.
- Marcella Cornia, Lorenzo Baraldi, and Rita Cucchiara. Show, control and tell: A framework for generating controllable and grounded captions. In *The IEEE Conference on Computer Vision and Pattern Recognition (CVPR)*, June 2019.
- Ionut Cosmin Duta, Bogdan Ionescu, Kiyoharu Aizawa, and Nicu Sebe. Spatio-temporal vector of locally max pooled features for action recognition in videos. In *The IEEE Conference on Computer Vision and Pattern Recognition (CVPR)*, July 2017.
- Luca Cosmo, Mikhail Panine, Arianna Rampini, Maks Ovsjanikov, Michael M. Bronstein, and Emanuele Rodola. Isospectralization, or how to hear shape, style, and correspondence. In *The IEEE Conference on Computer Vision and Pattern Recognition (CVPR)*, June 2019.
- Nieves Crasto, Philippe Weinzaepfel, Karteek Alahari, and Cordelia Schmid. Mars: Motion-augmented rgb stream for action recognition. In *The IEEE Conference on Computer Vision and Pattern Recognition (CVPR)*, June 2019.
- Marco Crocco, Cosimo Rubino, and Alessio Del Bue. Structure from motion with objects. In *The IEEE Conference on Computer Vision and Pattern Recognition (CVPR)*, June 2016.

- Ekin D. Cubuk, Barret Zoph, Dandelion Mane, Vijay Vasudevan, and Quoc V. Le. Autoaugment: Learning augmentation strategies from data. In *The IEEE Conference on Computer Vision and Pattern Recognition (CVPR)*, June 2019.
- Guillem Cucurull, Perouz Taslakian, and David Vazquez. Context-aware visual compatibility prediction. In *The IEEE Conference on Computer Vision and Pattern Recognition (CVPR)*, June 2019.
- Daniel Cudeiro, Timo Bolkart, Cassidy Laidlaw, Anurag Ranjan, and Michael J. Black. Capture, learning, and synthesis of 3d speaking styles. In *The IEEE Conference on Computer Vision and Pattern Recognition (CVPR)*, June 2019.
- Hainan Cui, Xiang Gao, Shuhan Shen, and Zhanyi Hu. Hsfm: Hybrid structure-from-motion. In *The IEEE Conference on Computer Vision and Pattern Recognition (CVPR)*, July 2017.
- Yin Cui, Feng Zhou, Yuanqing Lin, and Serge Belongie. Fine-grained categorization and dataset bootstrapping using deep metric learning with humans in the loop. In *The IEEE Conference on Computer Vision and Pattern Recognition (CVPR)*, June 2016.
- Yin Cui, Yang Song, Chen Sun, Andrew Howard, and Serge Belongie. Large scale fine-grained categorization and domain-specific transfer learning. In *The IEEE Conference on Computer Vision and Pattern Recognition (CVPR)*, June 2018.
- Zhiming Cui, Changjian Li, and Wenping Wang. Toothnet: Automatic tooth instance segmentation and identification from cone beam ct images. In *The IEEE Conference on Computer Vision and Pattern Recognition (CVPR)*, June 2019.
- Cheng Da, Shibiao Xu, Kun Ding, Gaofeng Meng, Shiming Xiang, and Chunhong Pan. Amvh: Asymmetric multi-valued hashing. In *The IEEE Conference on Computer Vision and Pattern Recognition (CVPR)*, July 2017.
- Angela Dai, Daniel Ritchie, Martin Bokeloh, Scott Reed, Jürgen Sturm, and Matthias Nießner. Scancomplete: Large-scale scene completion and semantic segmentation for 3d scans. In *The IEEE Conference on Computer Vision and Pattern Recognition (CVPR)*, June 2018.
- Bo Dai, Yuqi Zhang, and Dahua Lin. Detecting visual relationships with deep relational networks. In *The IEEE Conference on Computer Vision and Pattern Recognition (CVPR)*, July 2017.
- Jifeng Dai, Kaiming He, and Jian Sun. Instance-aware semantic segmentation via multi-task network cascades. In *The IEEE Conference on Computer Vision and Pattern Recognition (CVPR)*, June 2016.
- Kenan Dai, Dong Wang, Huchuan Lu, Chong Sun, and Jianhua Li. Visual tracking via adaptive spatially-regularized correlation filters. In *The IEEE Conference on Computer Vision and Pattern Recognition (CVPR)*, June 2019.
- Adrian V. Dalca, John Gutttag, and Mert R. Sabuncu. Anatomical priors in convolutional networks for unsupervised biomedical segmentation. In *The IEEE Conference on Computer Vision and Pattern Recognition (CVPR)*, June 2018.
- Martin Danelljan, Gustav Hager, Fahad Shahbaz Khan, and Michael Felsberg. Adaptive decontamination of the training set: A unified formulation for discriminative visual tracking. In *The IEEE Conference on Computer Vision and Pattern Recognition (CVPR)*, June 2016.
- Martin Danelljan, Goutam Bhat, Fahad Shahbaz Khan, and Michael Felsberg. Eco: Efficient convolution operators for tracking. In *The IEEE Conference on Computer Vision and Pattern Recognition (CVPR)*, July 2017.
- Martin Danelljan, Goutam Bhat, Fahad Shahbaz Khan, and Michael Felsberg. Atom: Accurate tracking by overlap maximization. In *The IEEE Conference on Computer Vision and Pattern Recognition (CVPR)*, June 2019.
- Arthur Daniel Costea and Sergiu Nedevschi. Semantic channels for fast pedestrian detection. In *The IEEE Conference on Computer Vision and Pattern Recognition (CVPR)*, June 2016.

- Arthur Daniel Costea, Robert Varga, and Sergiu Nedeveschi. Fast boosting based detection using scale invariant multimodal multiresolution filtered features. In *The IEEE Conference on Computer Vision and Pattern Recognition (CVPR)*, July 2017.
- Donald G. Dansereau, Glenn Schuster, Joseph Ford, and Gordon Wetzstein. A wide-field-of-view monocular light field camera. In *The IEEE Conference on Computer Vision and Pattern Recognition (CVPR)*, July 2017.
- Donald G. Dansereau, Bernd Girod, and Gordon Wetzstein. Liff: Light field features in scale and depth. In *The IEEE Conference on Computer Vision and Pattern Recognition (CVPR)*, June 2019.
- Mor Dar and Yael Moses. Temporal epipolar regions. In *The IEEE Conference on Computer Vision and Pattern Recognition (CVPR)*, June 2016.
- Abhishek Das, Satwik Kottur, Khushi Gupta, Avi Singh, Deshraj Yadav, Jose M. F. Moura, Devi Parikh, and Dhruv Batra. Visual dialog. In *The IEEE Conference on Computer Vision and Pattern Recognition (CVPR)*, July 2017.
- Abhishek Das, Samyak Datta, Georgia Gkioxari, Stefan Lee, Devi Parikh, and Dhruv Batra. Embodied question answering. In *The IEEE Conference on Computer Vision and Pattern Recognition (CVPR)*, June 2018.
- Saumitro Dasgupta, Kuan Fang, Kevin Chen, and Silvio Savarese. Delay: Robust spatial layout estimation for cluttered indoor scenes. In *The IEEE Conference on Computer Vision and Pattern Recognition (CVPR)*, June 2016.
- Achal Dave, Olga Russakovsky, and Deva Ramanan. Predictive-corrective networks for action detection. In *The IEEE Conference on Computer Vision and Pattern Recognition (CVPR)*, July 2017.
- Harm de Vries, Florian Strub, Sarath Chandar, Olivier Pietquin, Hugo Larochelle, and Aaron Courville. Guesswhat?! visual object discovery through multi-modal dialogue. In *The IEEE Conference on Computer Vision and Pattern Recognition (CVPR)*, July 2017.
- Joseph DeGol, Mani Golparvar-Fard, and Derek Hoiem. Geometry-informed material recognition. In *The IEEE Conference on Computer Vision and Pattern Recognition (CVPR)*, June 2016.
- Tali Dekel, Michael Rubinstein, Ce Liu, and William T. Freeman. On the effectiveness of visible watermarks. In *The IEEE Conference on Computer Vision and Pattern Recognition (CVPR)*, July 2017.
- Tali Dekel, Chuang Gan, Dilip Krishnan, Ce Liu, and William T. Freeman. Sparse, smart contours to represent and edit images. In *The IEEE Conference on Computer Vision and Pattern Recognition (CVPR)*, June 2018.
- Luca Del Pero, Susanna Ricco, Rahul Sukthankar, and Vittorio Ferrari. Discovering the physical parts of an articulated object class from multiple videos. In *The IEEE Conference on Computer Vision and Pattern Recognition (CVPR)*, June 2016.
- Girum G. Demisse, Djamila Aouada, and Bjorn Ottersten. Similarity metric for curved shapes in euclidean space. In *The IEEE Conference on Computer Vision and Pattern Recognition (CVPR)*, June 2016.
- Haowen Deng, Tolga Birdal, and Slobodan Ilic. Ppfnet: Global context aware local features for robust 3d point matching. In *The IEEE Conference on Computer Vision and Pattern Recognition (CVPR)*, June 2018.
- Haowen Deng, Tolga Birdal, and Slobodan Ilic. 3d local features for direct pairwise registration. In *The IEEE Conference on Computer Vision and Pattern Recognition (CVPR)*, June 2019.
- Zhiwei Deng, Arash Vahdat, Hexiang Hu, and Greg Mori. Structure inference machines: Recurrent neural networks for analyzing relations in group activity recognition. In *The IEEE Conference on Computer Vision and Pattern Recognition (CVPR)*. June 2016.

- Zhiwei Deng, Rajitha Navarathna, Peter Carr, Stephan Mandt, Yisong Yue, Iain Matthews, and Greg Mori. Factorized variational autoencoders for modeling audience reactions to movies. In *The IEEE Conference on Computer Vision and Pattern Recognition (CVPR)*, July 2017.
- Mohammad Mahdi Derakhshani, Saeed Masoudnia, Amir Hossein Shaker, Omid Mersa, Mohammad Amin Sadeghi, Mohammad Rastegari, and Babak N. Araabi. Assisted excitation of activations: A learning technique to improve object detectors. In *The IEEE Conference on Computer Vision and Pattern Recognition (CVPR)*, June 2019.
- Aditya Deshpande, Jiajun Lu, Mao-Chuang Yeh, Min Jin Chong, and David Forsyth. Learning diverse image colorization. In *The IEEE Conference on Computer Vision and Pattern Recognition (CVPR)*, July 2017.
- Ishan Deshpande, Ziyu Zhang, and Alexander G. Schwing. Generative modeling using the sliced wasserstein distance. In *The IEEE Conference on Computer Vision and Pattern Recognition (CVPR)*, June 2018.
- Ishan Deshpande, Yuan-Ting Hu, Ruoyu Sun, Ayis Pyrros, Nasir Siddiqui, Sanmi Koyejo, Zhizhen Zhao, David Forsyth, and Alexander G. Schwing. Max-sliced wasserstein distance and its use for gans. In *The IEEE Conference on Computer Vision and Pattern Recognition (CVPR)*, June 2019.
- Shay Deutsch, Soheil Kolouri, Kyunghnam Kim, Yuri Owechko, and Stefano Soatto. Zero shot learning via multi-scale manifold regularization. In *The IEEE Conference on Computer Vision and Pattern Recognition (CVPR)*, July 2017.
- Mustafa Devrim Kaba, Mustafa Gokhan Uzunbas, and Ser Nam Lim. A reinforcement learning approach to the view planning problem. In *The IEEE Conference on Computer Vision and Pattern Recognition (CVPR)*, July 2017.
- Sounak Dey, Pau Riba, Anjan Dutta, Josep Lladós, and Yi-Zhe Song. Doodle to search: Practical zero-shot sketch-based image retrieval. In *The IEEE Conference on Computer Vision and Pattern Recognition (CVPR)*, June 2019.
- Arturo Deza, Amit Surana, and Miguel P. Eckstein. Assessment of faster r-cnn in man-machine collaborative search. In *The IEEE Conference on Computer Vision and Pattern Recognition (CVPR)*, June 2019.
- Prithviraj Dhar, Rajat Vikram Singh, Kuan-Chuan Peng, Ziyang Wu, and Rama Chellappa. Learning without memorizing. In *The IEEE Conference on Computer Vision and Pattern Recognition (CVPR)*, June 2019.
- Aditya Dhawale, Kumar Shaurya Shankar, and Nathan Michael. Fast monte-carlo localization on aerial vehicles using approximate continuous belief representations. In *The IEEE Conference on Computer Vision and Pattern Recognition (CVPR)*, June 2018.
- Vikas Dhiman, Quoc-Huy Tran, Jason J. Corso, and Manmohan Chandraker. A continuous occlusion model for road scene understanding. In *The IEEE Conference on Computer Vision and Pattern Recognition (CVPR)*, June 2016.
- Renwei Dian, Leyuan Fang, and Shutao Li. Hyperspectral image super-resolution via non-local sparse tensor factorization. In *The IEEE Conference on Computer Vision and Pattern Recognition (CVPR)*, July 2017.
- Raul Diaz and Amit Marathe. Soft labels for ordinal regression. In *The IEEE Conference on Computer Vision and Pattern Recognition (CVPR)*, June 2019.
- Ali Diba, Ali Mohammad Pazandeh, Hamed Pirsiavash, and Luc Van Gool. Deepcamp: Deep convolutional action attribute mid-level patterns. In *The IEEE Conference on Computer Vision and Pattern Recognition (CVPR)*, June 2016.
- Ali Diba, Vivek Sharma, Ali Pazandeh, Hamed Pirsiavash, and Luc Van Gool. Weakly supervised cascaded convolutional networks. In *The IEEE Conference on Computer Vision and Pattern Recognition (CVPR)*, July 2017.

- Endri Dibra, Himanshu Jain, Cengiz Oztireli, Remo Ziegler, and Markus Gross. Human shape from silhouettes using generative hks descriptors and cross-modal neural networks. In *The IEEE Conference on Computer Vision and Pattern Recognition (CVPR)*, July 2017.
- Caglayan Dicle, Burak Yilmaz, Octavia Camps, and Mario Sznaiar. Solving temporal puzzles. In *The IEEE Conference on Computer Vision and Pattern Recognition (CVPR)*, June 2016.
- Maximilian Diebold, Bernd Jahne, and Alexander Gatto. Heterogeneous light fields. In *The IEEE Conference on Computer Vision and Pattern Recognition (CVPR)*, June 2016.
- Ferran Diego and Fred A. Hamprecht. Structured regression gradient boosting. In *The IEEE Conference on Computer Vision and Pattern Recognition (CVPR)*, June 2016.
- N. Dinesh Reddy, Minh Vo, and Srinivasa G. Narasimhan. Carfusion: Combining point tracking and part detection for dynamic 3d reconstruction of vehicles. In *The IEEE Conference on Computer Vision and Pattern Recognition (CVPR)*, June 2018.
- Henghui Ding, Xudong Jiang, Bing Shuai, Ai Qun Liu, and Gang Wang. Context contrasted feature and gated multi-scale aggregation for scene segmentation. In *The IEEE Conference on Computer Vision and Pattern Recognition (CVPR)*, June 2018.
- Jian Ding, Nan Xue, Yang Long, Gui-Song Xia, and Qikai Lu. Learning roi transformer for oriented object detection in aerial images. In *The IEEE Conference on Computer Vision and Pattern Recognition (CVPR)*, June 2019.
- Zhengming Ding, Ming Shao, and Yun Fu. Low-rank embedded ensemble semantic dictionary for zero-shot learning. In *The IEEE Conference on Computer Vision and Pattern Recognition (CVPR)*, July 2017.
- Mandar Dixit, Roland Kwitt, Marc Niethammer, and Nuno Vasconcelos. Aga: Attribute-guided augmentation. In *The IEEE Conference on Computer Vision and Pattern Recognition (CVPR)*, July 2017.
- Konstantin Dmitriev and Arie E. Kaufman. Learning multi-class segmentations from single-class datasets. In *The IEEE Conference on Computer Vision and Pattern Recognition (CVPR)*, June 2019.
- Thanh-Toan Do, Dang-Khoa Le Tan, Trung T. Pham, and Ngai-Man Cheung. Simultaneous feature aggregating and hashing for large-scale image search. In *The IEEE Conference on Computer Vision and Pattern Recognition (CVPR)*, July 2017.
- Thanh-Toan Do, Toan Tran, Ian Reid, Vijay Kumar, Tuan Hoang, and Gustavo Carneiro. A theoretically sound upper bound on the triplet loss for improving the efficiency of deep distance metric learning. In *The IEEE Conference on Computer Vision and Pattern Recognition (CVPR)*, June 2019.
- Pelin Dogan, Boyang Li, Leonid Sigal, and Markus Gross. A neural multi-sequence alignment technique (neumatch). In *The IEEE Conference on Computer Vision and Pattern Recognition (CVPR)*, June 2018.
- Pelin Dogan, Leonid Sigal, and Markus Gross. Neural sequential phrase grounding (seqground). In *The IEEE Conference on Computer Vision and Pattern Recognition (CVPR)*, June 2019.
- Pierre Dognin, Igor Melnyk, Youssef Mroueh, Jerret Ross, and Tom Sercu. Adversarial semantic alignment for improved image captions. In *The IEEE Conference on Computer Vision and Pattern Recognition (CVPR)*, June 2019.
- Brian Dolhansky and Cristian Canton Ferrer. Eye in-painting with exemplar generative adversarial networks. In *The IEEE Conference on Computer Vision and Pattern Recognition (CVPR)*, June 2018.
- Jose Dolz, Ismail Ben Ayed, and Christian Desrosiers. Dope: Distributed optimization for pairwise energies. In *The IEEE Conference on Computer Vision and Pattern Recognition (CVPR)*, July 2017.

- Jingming Dong, Xiaohan Fei, and Stefano Soatto. Visual-inertial-semantic scene representation for 3d object detection. In *The IEEE Conference on Computer Vision and Pattern Recognition (CVPR)*, July 2017.
- Xuanyi Dong and Yi Yang. Searching for a robust neural architecture in four gpu hours. In *The IEEE Conference on Computer Vision and Pattern Recognition (CVPR)*, June 2019.
- Xuanyi Dong, Shoou-I Yu, Xinshuo Weng, Shih-En Wei, Yi Yang, and Yaser Sheikh. Supervision-by-registration: An unsupervised approach to improve the precision of facial landmark detectors. In *The IEEE Conference on Computer Vision and Pattern Recognition (CVPR)*, June 2018.
- Simon Donne and Andreas Geiger. Learning non-volumetric depth fusion using successive reprojections. In *The IEEE Conference on Computer Vision and Pattern Recognition (CVPR)*, June 2019.
- Garoe Dorta, Sara Vicente, Lourdes Agapito, Neill D. F. Campbell, and Ivor Simpson. Structured uncertainty prediction networks. In *The IEEE Conference on Computer Vision and Pattern Recognition (CVPR)*, June 2018.
- Alexey Dosovitskiy and Thomas Brox. Inverting visual representations with convolutional networks. In *The IEEE Conference on Computer Vision and Pattern Recognition (CVPR)*, June 2016.
- Pengfei Dou, Shishir K. Shah, and Ioannis A. Kakadiaris. End-to-end 3d face reconstruction with deep neural networks. In *The IEEE Conference on Computer Vision and Pattern Recognition (CVPR)*, July 2017.
- Hazel Doughty, Dima Damen, and Walterio Mayol-Cuevas. Who's better? who's best? pairwise deep ranking for skill determination. In *The IEEE Conference on Computer Vision and Pattern Recognition (CVPR)*, June 2018.
- Hazel Doughty, Walterio Mayol-Cuevas, and Dima Damen. The pros and cons: Rank-aware temporal attention for skill determination in long videos. In *The IEEE Conference on Computer Vision and Pattern Recognition (CVPR)*, June 2019.
- Andreas Drounoglou, Rigas Kouskouridas, Sotiris Malassiotis, and Tae-Kyun Kim. Recovering 6d object pose and predicting next-best-view in the crowd. In *The IEEE Conference on Computer Vision and Pattern Recognition (CVPR)*, June 2016.
- Matthijs Douze, Arthur Szlam, Bharath Hariharan, and Hervé Jégou. Low-shot learning with large-scale diffusion. In *The IEEE Conference on Computer Vision and Pattern Recognition (CVPR)*, June 2018.
- Oren Dovrat, Itai Lang, and Shai Avidan. Learning to sample. In *The IEEE Conference on Computer Vision and Pattern Recognition (CVPR)*, June 2019.
- Kuo Du, Xiangbo Lin, Yi Sun, and Xiaohong Ma. Crossinonet: Multi-task information sharing based hand pose estimation. In *The IEEE Conference on Computer Vision and Pattern Recognition (CVPR)*, June 2019.
- Yang Du, Chunfeng Yuan, Bing Li, Weiming Hu, and Stephen Maybank. Spatio-temporal self-organizing map deep network for dynamic object detection from videos. In *The IEEE Conference on Computer Vision and Pattern Recognition (CVPR)*, July 2017.
- Yueqi Duan, Jiwen Lu, Ziwei Wang, Jianjiang Feng, and Jie Zhou. Learning deep binary descriptor with multi-quantization. In *The IEEE Conference on Computer Vision and Pattern Recognition (CVPR)*, July 2017.
- Yueqi Duan, Wenzhao Zheng, Xudong Lin, Jiwen Lu, and Jie Zhou. Deep adversarial metric learning. In *The IEEE Conference on Computer Vision and Pattern Recognition (CVPR)*, June 2018.
- Yueqi Duan, Yu Zheng, Jiwen Lu, Jie Zhou, and Qi Tian. Structural relational reasoning of point clouds. In *The IEEE Conference on Computer Vision and Pattern Recognition (CVPR)*, June 2019.

- Abhimanyu Dubey, Laurens van der Maaten, Zeki Yalniz, Yixuan Li, and Dhruv Mahajan. Defense against adversarial images using web-scale nearest-neighbor search. In *The IEEE Conference on Computer Vision and Pattern Recognition (CVPR)*, June 2019.
- Chi Nhan Duong, Khoa Luu, Kha Gia Quach, Nghia Nguyen, Eric Patterson, Tien D. Bui, and Ngan Le. Automatic face aging in videos via deep reinforcement learning. In *The IEEE Conference on Computer Vision and Pattern Recognition (CVPR)*, June 2019.
- Thibaut Durand, Nicolas Thome, and Matthieu Cord. Weldon: Weakly supervised learning of deep convolutional neural networks. In *The IEEE Conference on Computer Vision and Pattern Recognition (CVPR)*, June 2016.
- Thibaut Durand, Taylor Mordan, Nicolas Thome, and Matthieu Cord. Wildcat: Weakly supervised learning of deep convnets for image classification, pointwise localization and segmentation. In *The IEEE Conference on Computer Vision and Pattern Recognition (CVPR)*, July 2017.
- Thibaut Durand, Nazanin Mehrasa, and Greg Mori. Learning a deep convnet for multi-label classification with partial labels. In *The IEEE Conference on Computer Vision and Pattern Recognition (CVPR)*, June 2019.
- Mihai Dusmanu, Ignacio Rocco, Tomas Pajdla, Marc Pollefeys, Josef Sivic, Akihiko Torii, and Torsten Sattler. D2-net: A trainable cnn for joint description and detection of local features. In *The IEEE Conference on Computer Vision and Pattern Recognition (CVPR)*, June 2019.
- Suyog Dutt Jain and Kristen Grauman. Active image segmentation propagation. In *The IEEE Conference on Computer Vision and Pattern Recognition (CVPR)*, June 2016.
- Suyog Dutt Jain, Bo Xiong, and Kristen Grauman. Fusionseg: Learning to combine motion and appearance for fully automatic segmentation of generic objects in videos. In *The IEEE Conference on Computer Vision and Pattern Recognition (CVPR)*, July 2017.
- Anjan Dutta and Zeynep Akata. Semantically tied paired cycle consistency for zero-shot sketch-based image retrieval. In *The IEEE Conference on Computer Vision and Pattern Recognition (CVPR)*, June 2019.
- Debidatta Dwibedi, Yusuf Aytar, Jonathan Tompson, Pierre Sermanet, and Andrew Zisserman. Temporal cycle-consistency learning. In *The IEEE Conference on Computer Vision and Pattern Recognition (CVPR)*, June 2019.
- Kshitij Dwivedi and Gemma Roig. Representation similarity analysis for efficient task taxonomy transfer learning. In *The IEEE Conference on Computer Vision and Pattern Recognition (CVPR)*, June 2019.
- Benjamin Eckart, Kihwan Kim, Alejandro Troccoli, Alonzo Kelly, and Jan Kautz. Accelerated generative models for 3d point cloud data. In *The IEEE Conference on Computer Vision and Pattern Recognition (CVPR)*, June 2016.
- Hamid Eghbal-zadeh, Werner Zellinger, and Gerhard Widmer. Mixture density generative adversarial networks. In *The IEEE Conference on Computer Vision and Pattern Recognition (CVPR)*, June 2019.
- Sepehr Eghbali and Ladan Tahvildari. Deep spherical quantization for image search. In *The IEEE Conference on Computer Vision and Pattern Recognition (CVPR)*, June 2019.
- Thibaud Ehret and Pablo Arias. On the convergence of patchmatch and its variants. In *The IEEE Conference on Computer Vision and Pattern Recognition (CVPR)*, June 2018.
- Thibaud Ehret, Axel Davy, Jean-Michel Morel, Gabriele Facciolo, and Pablo Arias. Model-blind video denoising via frame-to-frame training. In *The IEEE Conference on Computer Vision and Pattern Recognition (CVPR)*, June 2019.
- M. Ehsan Abbasnejad, Anthony Dick, and Anton van den Hengel. Infinite variational autoencoder for semi-supervised learning. In *The IEEE Conference on Computer Vision and Pattern Recognition (CVPR)*, July 2017.

- Kiana Ehsani, Hessam Bagherinezhad, Joseph Redmon, Roozbeh Mottaghi, and Ali Farhadi. Who let the dogs out? modeling dog behavior from visual data. In *The IEEE Conference on Computer Vision and Pattern Recognition (CVPR)*, June 2018.
- Gabriel Eilertsen, Rafal K. Mantiuk, and Jonas Unger. Single-frame regularization for temporally stable cnns. In *The IEEE Conference on Computer Vision and Pattern Recognition (CVPR)*, June 2019.
- Aviv Eisenschat and Lior Wolf. Linking image and text with 2-way nets. In *The IEEE Conference on Computer Vision and Pattern Recognition (CVPR)*, July 2017.
- Gil Elbaz, Tamar Avraham, and Anath Fischer. 3d point cloud registration for localization using a deep neural network auto-encoder. In *The IEEE Conference on Computer Vision and Pattern Recognition (CVPR)*, July 2017.
- Shireen Elhabian and Ross Whitaker. Shapeodds: Variational bayesian learning of generative shape models. In *The IEEE Conference on Computer Vision and Pattern Recognition (CVPR)*, July 2017.
- Ehsan Elhamifar and M. Clara De Paolis Kaluza. Online summarization via submodular and convex optimization. In *The IEEE Conference on Computer Vision and Pattern Recognition (CVPR)*, July 2017.
- Mohamed Elhoseiny, Yizhe Zhu, Han Zhang, and Ahmed Elgammal. Link the head to the "beak": Zero shot learning from noisy text description at part precision. In *The IEEE Conference on Computer Vision and Pattern Recognition (CVPR)*, July 2017.
- Martin Engilberge, Louis Chevallier, Patrick Pérez, and Matthieu Cord. Finding beans in burgers: Deep semantic-visual embedding with localization. In *The IEEE Conference on Computer Vision and Pattern Recognition (CVPR)*, June 2018.
- Martin Engilberge, Louis Chevallier, Patrick Perez, and Matthieu Cord. Sodeep: A sorting deep net to learn ranking loss surrogates. In *The IEEE Conference on Computer Vision and Pattern Recognition (CVPR)*, June 2019.
- Ertunc Erdil, Sinan Yildirim, Mujdat Cetin, and Tolga Tasdizen. Mcmc shape sampling for image segmentation with nonparametric shape priors. In *The IEEE Conference on Computer Vision and Pattern Recognition (CVPR)*, June 2016.
- Anders Eriksson, John Bastian, Tat-Jun Chin, and Mats Isaksson. A consensus-based framework for distributed bundle adjustment. In *The IEEE Conference on Computer Vision and Pattern Recognition (CVPR)*, June 2016.
- Anders Eriksson, Carl Olsson, Fredrik Kahl, and Tat-Jun Chin. Rotation averaging and strong duality. In *The IEEE Conference on Computer Vision and Pattern Recognition (CVPR)*, June 2018.
- Seyed A. Esmaeili, Bharat Singh, and Larry S. Davis. Fast-at: Fast automatic thumbnail generation using deep neural networks. In *The IEEE Conference on Computer Vision and Pattern Recognition (CVPR)*, July 2017.
- Patrick Esser, Ekaterina Sutter, and Björn Ommer. A variational u-net for conditional appearance and shape generation. In *The IEEE Conference on Computer Vision and Pattern Recognition (CVPR)*, June 2018.
- Kevin Eykholt, Ivan Evtimov, Earlene Fernandes, Bo Li, Amir Rahmati, Chaowei Xiao, Atul Prakash, Tadayoshi Kohno, and Dawn Song. Robust physical-world attacks on deep learning visual classification. In *The IEEE Conference on Computer Vision and Pattern Recognition (CVPR)*, June 2018.
- C. Fabian Benitez-Quiroz, Ramprakash Srinivasan, and Aleix M. Martinez. Emotionet: An accurate, real-time algorithm for the automatic annotation of a million facial expressions in the wild. In *The IEEE Conference on Computer Vision and Pattern Recognition (CVPR)*, June 2016.

- Jose M. Facil, Benjamin Ummenhofer, Huizhong Zhou, Luis Montesano, Thomas Brox, and Javier Civera. Cam-convs: Camera-aware multi-scale convolutions for single-view depth. In *The IEEE Conference on Computer Vision and Pattern Recognition (CVPR)*, June 2019.
- Jiri Fajtl, Vasileios Argyriou, Dorothy Monekosso, and Paolo Remagnino. Amnet: Memorability estimation with attention. In *The IEEE Conference on Computer Vision and Pattern Recognition (CVPR)*, June 2018.
- Chenyou Fan, Xiaofan Zhang, Shu Zhang, Wensheng Wang, Chi Zhang, and Heng Huang. Heterogeneous memory enhanced multimodal attention model for video question answering. In *The IEEE Conference on Computer Vision and Pattern Recognition (CVPR)*, June 2019.
- Haoqi Fan and Jiatong Zhou. Stacked latent attention for multimodal reasoning. In *The IEEE Conference on Computer Vision and Pattern Recognition (CVPR)*, June 2018.
- Haoqiang Fan, Hao Su, and Leonidas J. Guibas. A point set generation network for 3d object reconstruction from a single image. In *The IEEE Conference on Computer Vision and Pattern Recognition (CVPR)*, July 2017.
- Shaojing Fan, Tian-Tsong Ng, Bryan L. Koenig, Ming Jiang, and Qi Zhao. A paradigm for building generalized models of human image perception through data fusion. In *The IEEE Conference on Computer Vision and Pattern Recognition (CVPR)*, June 2016.
- Hao-Shu Fang, Guansong Lu, Xiaolin Fang, Jianwen Xie, Yu-Wing Tai, and Cewu Lu. Weakly and semi supervised human body part parsing via pose-guided knowledge transfer. In *The IEEE Conference on Computer Vision and Pattern Recognition (CVPR)*, June 2018.
- Kuan Fang, Alexander Toshev, Li Fei-Fei, and Silvio Savarese. Scene memory transformer for embodied agents in long-horizon tasks. In *The IEEE Conference on Computer Vision and Pattern Recognition (CVPR)*, June 2019.
- Julian Faraone, Nicholas Fraser, Michaela Blott, and Philip H.W. Leong. Syq: Learning symmetric quantization for efficient deep neural networks. In *The IEEE Conference on Computer Vision and Pattern Recognition (CVPR)*, June 2018.
- Yazan Abu Farha and Jurgen Gall. Ms-tcn: Multi-stage temporal convolutional network for action segmentation. In *The IEEE Conference on Computer Vision and Pattern Recognition (CVPR)*, June 2019.
- Alhussein Fawzi, Seyed-Mohsen Moosavi-Dezfooli, Pascal Frossard, and Stefano Soatto. Empirical study of the topology and geometry of deep networks. In *The IEEE Conference on Computer Vision and Pattern Recognition (CVPR)*, June 2018.
- Christoph Feichtenhofer, Axel Pinz, and Andrew Zisserman. Convolutional two-stream network fusion for video action recognition. In *The IEEE Conference on Computer Vision and Pattern Recognition (CVPR)*, June 2016.
- Christoph Feichtenhofer, Axel Pinz, and Richard P. Wildes. Temporal residual networks for dynamic scene recognition. In *The IEEE Conference on Computer Vision and Pattern Recognition (CVPR)*, July 2017.
- Christoph Feichtenhofer, Axel Pinz, Richard P. Wildes, and Andrew Zisserman. What have we learned from deep representations for action recognition? In *The IEEE Conference on Computer Vision and Pattern Recognition (CVPR)*, June 2018.
- Jie Feng, Brian Price, Scott Cohen, and Shih-Fu Chang. Interactive segmentation on rgb-d images via cue selection. In *The IEEE Conference on Computer Vision and Pattern Recognition (CVPR)*, June 2016.
- Yang Feng, Lin Ma, Wei Liu, and Jiebo Luo. Spatio-temporal video re-localization by warp lstm. In *The IEEE Conference on Computer Vision and Pattern Recognition (CVPR)*, June 2019.

- Yifan Feng, Zizhao Zhang, Xibin Zhao, Rongrong Ji, and Yue Gao. Gvcnn: Group-view convolutional neural networks for 3d shape recognition. In *The IEEE Conference on Computer Vision and Pattern Recognition (CVPR)*, June 2018.
- Zhen-Hua Feng, Josef Kittler, William Christmas, Patrik Huber, and Xiao-Jun Wu. Dynamic attention-controlled cascaded shape regression exploiting training data augmentation and fuzzy-set sample weighting. In *The IEEE Conference on Computer Vision and Pattern Recognition (CVPR)*, July 2017.
- Basura Fernando, Peter Anderson, Marcus Hutter, and Stephen Gould. Discriminative hierarchical rank pooling for activity recognition. In *The IEEE Conference on Computer Vision and Pattern Recognition (CVPR)*, June 2016.
- Basura Fernando, Hakan Bilen, Efstratios Gavves, and Stephen Gould. Self-supervised video representation learning with odd-one-out networks. In *The IEEE Conference on Computer Vision and Pattern Recognition (CVPR)*, July 2017.
- Matthias Fey, Jan Eric Lenssen, Frank Weichert, and Heinrich Müller. Splinecnn: Fast geometric deep learning with continuous b-spline kernels. In *The IEEE Conference on Computer Vision and Pattern Recognition (CVPR)*, June 2018.
- Michael Figurnov, Maxwell D. Collins, Yukun Zhu, Li Zhang, Jonathan Huang, Dmitry Vetrov, and Ruslan Salakhutdinov. Spatially adaptive computation time for residual networks. In *The IEEE Conference on Computer Vision and Pattern Recognition (CVPR)*, July 2017.
- Michael Firman, Oisin Mac Aodha, Simon Julier, and Gabriel J. Brostow. Structured prediction of unobserved voxels from a single depth image. In *The IEEE Conference on Computer Vision and Pattern Recognition (CVPR)*, June 2016.
- Michael Firman, Neill D. F. Campbell, Lourdes Agapito, and Gabriel J. Brostow. Diversenet: When one right answer is not enough. In *The IEEE Conference on Computer Vision and Pattern Recognition (CVPR)*, June 2018.
- John Flynn, Ivan Neulander, James Philbin, and Noah Snavely. Deepstereo: Learning to predict new views from the world’s imagery. In *The IEEE Conference on Computer Vision and Pattern Recognition (CVPR)*, June 2016.
- John Flynn, Michael Broxton, Paul Debevec, Matthew DuVall, Graham Fyffe, Ryan Overbeck, Noah Snavely, and Richard Tucker. Deepview: View synthesis with learned gradient descent. In *The IEEE Conference on Computer Vision and Pattern Recognition (CVPR)*, June 2019.
- Ruth Fong and Andrea Vedaldi. Net2vec: Quantifying and explaining how concepts are encoded by filters in deep neural networks. In *The IEEE Conference on Computer Vision and Pattern Recognition (CVPR)*, June 2018.
- David F. Fouhey, Abhinav Gupta, and Andrew Zisserman. 3d shape attributes. In *The IEEE Conference on Computer Vision and Pattern Recognition (CVPR)*, June 2016.
- David F. Fouhey, Wei-cheng Kuo, Alexei A. Efros, and Jitendra Malik. From lifestyle vlogs to everyday interactions. In *The IEEE Conference on Computer Vision and Pattern Recognition (CVPR)*, June 2018.
- Johan Fredriksson, Viktor Larsson, Carl Olsson, and Fredrik Kahl. Optimal relative pose with unknown correspondences. In *The IEEE Conference on Computer Vision and Pattern Recognition (CVPR)*, June 2016.
- Oriel Frigo, Neus Sabater, Julie Delon, and Pierre Hellier. Split and match: Example-based adaptive patch sampling for unsupervised style transfer. In *The IEEE Conference on Computer Vision and Pattern Recognition (CVPR)*, June 2016.
- Huan Fu, Chaohui Wang, Dacheng Tao, and Michael J. Black. Occlusion boundary detection via deep exploration of context. In *The IEEE Conference on Computer Vision and Pattern Recognition (CVPR)*, June 2016.

- Huan Fu, Mingming Gong, Chaohui Wang, Kayhan Batmanghelich, and Dacheng Tao. Deep ordinal regression network for monocular depth estimation. In *The IEEE Conference on Computer Vision and Pattern Recognition (CVPR)*, June 2018.
- Huan Fu, Mingming Gong, Chaohui Wang, Kayhan Batmanghelich, Kun Zhang, and Dacheng Tao. Geometry-consistent generative adversarial networks for one-sided unsupervised domain mapping. In *The IEEE Conference on Computer Vision and Pattern Recognition (CVPR)*, June 2019.
- Xueyang Fu, Jiabin Huang, Delu Zeng, Yue Huang, Xinghao Ding, and John Paisley. Removing rain from single images via a deep detail network. In *The IEEE Conference on Computer Vision and Pattern Recognition (CVPR)*, July 2017.
- Yuki Fujimura, Masaaki Iiyama, Atsushi Hashimoto, and Michihiko Minoh. Photometric stereo in participating media considering shape-dependent forward scatter. In *The IEEE Conference on Computer Vision and Pattern Recognition (CVPR)*, June 2018.
- Hiroshi Fukui, Tsubasa Hirakawa, Takayoshi Yamashita, and Hironobu Fujiyoshi. Attention branch network: Learning of attention mechanism for visual explanation. In *The IEEE Conference on Computer Vision and Pattern Recognition (CVPR)*, June 2019.
- Chris Funk and Yanxi Liu. Symmetry recaptcha. In *The IEEE Conference on Computer Vision and Pattern Recognition (CVPR)*, June 2016.
- David Gadot and Lior Wolf. Patchbatch: A batch augmented loss for optical flow. In *The IEEE Conference on Computer Vision and Pattern Recognition (CVPR)*, June 2016.
- Adrien Gaidon, Qiao Wang, Yohann Cabon, and Eleonora Vig. Virtual worlds as proxy for multi-object tracking analysis. In *The IEEE Conference on Computer Vision and Pattern Recognition (CVPR)*, June 2016.
- Adrian Galdran, Aitor Alvarez-Gila, Alessandro Bria, Javier Vazquez-Corral, and Marcelo Bertalmío. On the duality between retinex and image dehazing. In *The IEEE Conference on Computer Vision and Pattern Recognition (CVPR)*, June 2018.
- Guillermo Gallego, Henri Rebecq, and Davide Scaramuzza. A unifying contrast maximization framework for event cameras, with applications to motion, depth, and optical flow estimation. In *The IEEE Conference on Computer Vision and Pattern Recognition (CVPR)*, June 2018.
- Guillermo Gallego, Mathias Gehrig, and Davide Scaramuzza. Focus is all you need: Loss functions for event-based vision. In *The IEEE Conference on Computer Vision and Pattern Recognition (CVPR)*, June 2019.
- Silvano Galliani and Konrad Schindler. Just look at the image: Viewpoint-specific surface normal prediction for improved multi-view reconstruction. In *The IEEE Conference on Computer Vision and Pattern Recognition (CVPR)*, June 2016.
- Chuang Gan, Tianbao Yang, and Boqing Gong. Learning attributes equals multi-source domain generalization. In *The IEEE Conference on Computer Vision and Pattern Recognition (CVPR)*, June 2016.
- Chuang Gan, Zhe Gan, Xiaodong He, Jianfeng Gao, and Li Deng. Stylenet: Generating attractive visual captions with styles. In *The IEEE Conference on Computer Vision and Pattern Recognition (CVPR)*, July 2017.
- Chuang Gan, Boqing Gong, Kun Liu, Hao Su, and Leonidas J. Guibas. Geometry guided convolutional neural networks for self-supervised video representation learning. In *The IEEE Conference on Computer Vision and Pattern Recognition (CVPR)*, June 2018.
- Yosef Gandelsman, Assaf Shocher, and Michal Irani. "double-dip": Unsupervised image decomposition via coupled deep-image-priors. In *The IEEE Conference on Computer Vision and Pattern Recognition (CVPR)*, June 2019.

- Siddha Ganju, Olga Russakovsky, and Abhinav Gupta. What's in a question: Using visual questions as a form of supervision. In *The IEEE Conference on Computer Vision and Pattern Recognition (CVPR)*, July 2017.
- Ruohan Gao and Kristen Grauman. 2.5d visual sound. In *The IEEE Conference on Computer Vision and Pattern Recognition (CVPR)*, June 2019.
- Ruohan Gao, Bo Xiong, and Kristen Grauman. Im2flow: Motion hallucination from static images for action recognition. In *The IEEE Conference on Computer Vision and Pattern Recognition (CVPR)*, June 2018.
- Yang Gao, Oscar Beijbom, Ning Zhang, and Trevor Darrell. Compact bilinear pooling. In *The IEEE Conference on Computer Vision and Pattern Recognition (CVPR)*, June 2016.
- Zhanning Gao, Gang Hua, Dongqing Zhang, Nebojsa Jovic, Le Wang, Jianru Xue, and Nanning Zheng. Er3: A unified framework for event retrieval, recognition and recounting. In *The IEEE Conference on Computer Vision and Pattern Recognition (CVPR)*, July 2017.
- Guillermo Garcia-Hernando and Tae-Kyun Kim. Transition forests: Learning discriminative temporal transitions for action recognition and detection. In *The IEEE Conference on Computer Vision and Pattern Recognition (CVPR)*, July 2017.
- Guillermo Garcia-Hernando, Shanxin Yuan, Seungryul Baek, and Tae-Kyun Kim. First-person hand action benchmark with rgb-d videos and 3d hand pose annotations. In *The IEEE Conference on Computer Vision and Pattern Recognition (CVPR)*, June 2018.
- Mathieu Garon, Kalyan Sunkavalli, Sunil Hadap, Nathan Carr, and Jean-Francois Lalonde. Fast spatially-varying indoor lighting estimation. In *The IEEE Conference on Computer Vision and Pattern Recognition (CVPR)*, June 2019.
- Jochen Gast and Stefan Roth. Lightweight probabilistic deep networks. In *The IEEE Conference on Computer Vision and Pattern Recognition (CVPR)*, June 2018.
- Jochen Gast, Anita Sellent, and Stefan Roth. Parametric object motion from blur. In *The IEEE Conference on Computer Vision and Pattern Recognition (CVPR)*, June 2016.
- Vijetha Gattupalli, Yaoxin Zhuo, and Baoxin Li. Weakly supervised deep image hashing through tag embeddings. In *The IEEE Conference on Computer Vision and Pattern Recognition (CVPR)*, June 2019.
- Leon A. Gatys, Alexander S. Ecker, and Matthias Bethge. Image style transfer using convolutional neural networks. In *The IEEE Conference on Computer Vision and Pattern Recognition (CVPR)*, June 2016.
- Leon A. Gatys, Alexander S. Ecker, Matthias Bethge, Aaron Hertzmann, and Eli Shechtman. Controlling perceptual factors in neural style transfer. In *The IEEE Conference on Computer Vision and Pattern Recognition (CVPR)*, July 2017.
- Kirill Gavrilyuk, Amir Ghodrati, Zhenyang Li, and Cees G. M. Snoek. Actor and action video segmentation from a sentence. In *The IEEE Conference on Computer Vision and Pattern Recognition (CVPR)*, June 2018.
- Liuhaohao Ge, Hui Liang, Junsong Yuan, and Daniel Thalmann. Robust 3d hand pose estimation in single depth images: From single-view cnn to multi-view cnns. In *The IEEE Conference on Computer Vision and Pattern Recognition (CVPR)*, June 2016.
- Weifeng Ge and Yizhou Yu. Borrowing treasures from the wealthy: Deep transfer learning through selective joint fine-tuning. In *The IEEE Conference on Computer Vision and Pattern Recognition (CVPR)*, July 2017.
- Weifeng Ge, Sibe Yang, and Yizhou Yu. Multi-evidence filtering and fusion for multi-label classification, object detection and semantic segmentation based on weakly supervised learning. In *The IEEE Conference on Computer Vision and Pattern Recognition (CVPR)*, June 2018.

- Weifeng Ge, Xiangru Lin, and Yizhou Yu. Weakly supervised complementary parts models for fine-grained image classification from the bottom up. In *The IEEE Conference on Computer Vision and Pattern Recognition (CVPR)*, June 2019.
- Baris Gecer, Stylianos Ploumpis, Irene Kotsia, and Stefanos Zafeiriou. Ganfit: Generative adversarial network fitting for high fidelity 3d face reconstruction. In *The IEEE Conference on Computer Vision and Pattern Recognition (CVPR)*, June 2019.
- Patrick Geneva, James Maley, and Guoquan Huang. An efficient schmidt-ekf for 3d visual-inertial slam. In *The IEEE Conference on Computer Vision and Pattern Recognition (CVPR)*, June 2019.
- Zhenglin Geng, Chen Cao, and Sergey Tulyakov. 3d guided fine-grained face manipulation. In *The IEEE Conference on Computer Vision and Pattern Recognition (CVPR)*, June 2019.
- Kyle Genova, Forrester Cole, Aaron Maschinot, Aaron Sarna, Daniel Vlasic, and William T. Freeman. Unsupervised training for 3d morphable model regression. In *The IEEE Conference on Computer Vision and Pattern Recognition (CVPR)*, June 2018.
- Georgios Georgakis, Srikrishna Karanam, Ziyang Wu, Jan Ernst, and Jana Košecká. End-to-end learning of keypoint detector and descriptor for pose invariant 3d matching. In *The IEEE Conference on Computer Vision and Pattern Recognition (CVPR)*, June 2018.
- Georgios Georgiadis. Accelerating convolutional neural networks via activation map compression. In *The IEEE Conference on Computer Vision and Pattern Recognition (CVPR)*, June 2019.
- Deepti Ghadiyaram, Du Tran, and Dhruv Mahajan. Large-scale weakly-supervised pre-training for video action recognition. In *The IEEE Conference on Computer Vision and Pattern Recognition (CVPR)*, June 2019.
- Kamran Ghasedi, Xiaoqian Wang, Cheng Deng, and Heng Huang. Balanced self-paced learning for generative adversarial clustering network. In *The IEEE Conference on Computer Vision and Pattern Recognition (CVPR)*, June 2019.
- Kamran Ghasedi Dizaji, Feng Zheng, Najmeh Sadoughi, Yanhua Yang, Cheng Deng, and Heng Huang. Unsupervised deep generative adversarial hashing network. In *The IEEE Conference on Computer Vision and Pattern Recognition (CVPR)*, June 2018.
- Golnaz Ghiasi, Tsung-Yi Lin, and Quoc V. Le. Nas-fpn: Learning scalable feature pyramid architecture for object detection. In *The IEEE Conference on Computer Vision and Pattern Recognition (CVPR)*, June 2019.
- Behnam Gholami and Vladimir Pavlovic. Probabilistic temporal subspace clustering. In *The IEEE Conference on Computer Vision and Pattern Recognition (CVPR)*, July 2017.
- Arnab Ghosh, Viveka Kulharia, Vinay P. Namboodiri, Philip H.S. Torr, and Puneet K. Dokania. Multi-agent diverse generative adversarial networks. In *The IEEE Conference on Computer Vision and Pattern Recognition (CVPR)*, June 2018.
- Soumyadeep Ghosh, Richa Singh, and Mayank Vatsa. On learning density aware embeddings. In *The IEEE Conference on Computer Vision and Pattern Recognition (CVPR)*, June 2019.
- Silvio Giancola, Jesus Zarzar, and Bernard Ghanem. Leveraging shape completion for 3d siamese tracking. In *The IEEE Conference on Computer Vision and Pattern Recognition (CVPR)*, June 2019.
- Spyros Gidaris and Nikos Komodakis. Locnet: Improving localization accuracy for object detection. In *The IEEE Conference on Computer Vision and Pattern Recognition (CVPR)*, June 2016.
- Spyros Gidaris and Nikos Komodakis. Detect, replace, refine: Deep structured prediction for pixel wise labeling. In *The IEEE Conference on Computer Vision and Pattern Recognition (CVPR)*, July 2017.
- Spyros Gidaris and Nikos Komodakis. Dynamic few-shot visual learning without forgetting. In *The IEEE Conference on Computer Vision and Pattern Recognition (CVPR)*, June 2018.

- Spyros Gidaris and Nikos Komodakis. Generating classification weights with gnn denoising autoencoders for few-shot learning. In *The IEEE Conference on Computer Vision and Pattern Recognition (CVPR)*, June 2019.
- Andrew Gilbert, John Collomosse, Hailin Jin, and Brian Price. Disentangling structure and aesthetics for style-aware image completion. In *The IEEE Conference on Computer Vision and Pattern Recognition (CVPR)*, June 2018.
- Shiry Ginosar, Amir Bar, Gefen Kohavi, Caroline Chan, Andrew Owens, and Jitendra Malik. Learning individual styles of conversational gesture. In *The IEEE Conference on Computer Vision and Pattern Recognition (CVPR)*, June 2019.
- Rohit Girdhar, Deva Ramanan, Abhinav Gupta, Josef Sivic, and Bryan Russell. Actionvlad: Learning spatio-temporal aggregation for action classification. In *The IEEE Conference on Computer Vision and Pattern Recognition (CVPR)*, July 2017.
- Rohit Girdhar, Georgia Gkioxari, Lorenzo Torresani, Manohar Paluri, and Du Tran. Detect-and-track: Efficient pose estimation in videos. In *The IEEE Conference on Computer Vision and Pattern Recognition (CVPR)*, June 2018.
- Rohit Girdhar, Joao Carreira, Carl Doersch, and Andrew Zisserman. Video action transformer network. In *The IEEE Conference on Computer Vision and Pattern Recognition (CVPR)*, June 2019.
- Georgia Gkioxari, Ross Girshick, Piotr Dollár, and Kaiming He. Detecting and recognizing human-object interactions. In *The IEEE Conference on Computer Vision and Pattern Recognition (CVPR)*, June 2018.
- Clement Godard, Oisín Mac Aodha, and Gabriel J. Brostow. Unsupervised monocular depth estimation with left-right consistency. In *The IEEE Conference on Computer Vision and Pattern Recognition (CVPR)*, July 2017.
- Arushi Goel, Keng Teck Ma, and Cheston Tan. An end-to-end network for generating social relationship graphs. In *The IEEE Conference on Computer Vision and Pattern Recognition (CVPR)*, June 2019.
- Zan Gojcic, Caifa Zhou, Jan D. Wegner, and Andreas Wieser. The perfect match: 3d point cloud matching with smoothed densities. In *The IEEE Conference on Computer Vision and Pattern Recognition (CVPR)*, June 2019.
- Eran Goldman, Roei Herzig, Aviv Eisenschat, Jacob Goldberger, and Tal Hassner. Precise detection in densely packed scenes. In *The IEEE Conference on Computer Vision and Pattern Recognition (CVPR)*, June 2019.
- Vladislav Golyanik, Sk Aziz Ali, and Didier Stricker. Gravitational approach for point set registration. In *The IEEE Conference on Computer Vision and Pattern Recognition (CVPR)*, June 2016.
- Lluis Gomez, Yash Patel, Marçal Rusinol, Dimosthenis Karatzas, and C. V. Jawahar. Self-supervised learning of visual features through embedding images into text topic spaces. In *The IEEE Conference on Computer Vision and Pattern Recognition (CVPR)*, July 2017.
- Alexander Gomez-Villa, Adrian Martin, Javier Vazquez-Corral, and Marcelo Bertalmio. Convolutional neural networks can be deceived by visual illusions. In *The IEEE Conference on Computer Vision and Pattern Recognition (CVPR)*, June 2019.
- Dong Gong, Mingkui Tan, Yanning Zhang, Anton van den Hengel, and Qinfeng Shi. Blind image deconvolution by automatic gradient activation. In *The IEEE Conference on Computer Vision and Pattern Recognition (CVPR)*, June 2016.
- Ke Gong, Xiaodan Liang, Dongyu Zhang, Xiaohui Shen, and Liang Lin. Look into person: Self-supervised structure-sensitive learning and a new benchmark for human parsing. In *The IEEE Conference on Computer Vision and Pattern Recognition (CVPR)*, July 2017.

- Rui Gong, Wen Li, Yuhua Chen, and Luc Van Gool. Dlow: Domain flow for adaptation and generalization. In *The IEEE Conference on Computer Vision and Pattern Recognition (CVPR)*, June 2019.
- Yunye Gong, Srikrishna Karanam, Ziyang Wu, Kuan-Chuan Peng, Jan Ernst, and Peter C. Doerschuk. Learning compositional visual concepts with mutual consistency. In *The IEEE Conference on Computer Vision and Pattern Recognition (CVPR)*, June 2018.
- Abel Gonzalez-Garcia, Davide Modolo, and Vittorio Ferrari. Objects as context for detecting their semantic parts. In *The IEEE Conference on Computer Vision and Pattern Recognition (CVPR)*, June 2018.
- Anand Gopalakrishnan, Ankur Mali, Dan Kifer, Lee Giles, and Alexander G. Ororbia. A neural temporal model for human motion prediction. In *The IEEE Conference on Computer Vision and Pattern Recognition (CVPR)*, June 2019.
- Albert Gordo and Diane Larlus. Beyond instance-level image retrieval: Leveraging captions to learn a global visual representation for semantic retrieval. In *The IEEE Conference on Computer Vision and Pattern Recognition (CVPR)*, July 2017.
- Ariel Gordon, Elad Eban, Ofir Nachum, Bo Chen, Hao Wu, Tien-Ju Yang, and Edward Choi. Morphnet: Fast simple resource-constrained structure learning of deep networks. In *The IEEE Conference on Computer Vision and Pattern Recognition (CVPR)*, June 2018.
- Lena Gorelick, Yuri Boykov, and Olga Veksler. Adaptive and move making auxiliary cuts for binary pairwise energies. In *The IEEE Conference on Computer Vision and Pattern Recognition (CVPR)*, July 2017.
- Siavash Gorji and James J. Clark. Attentional push: A deep convolutional network for augmenting image saliency with shared attention modeling in social scenes. In *The IEEE Conference on Computer Vision and Pattern Recognition (CVPR)*, July 2017.
- Siavash Gorji and James J. Clark. Going from image to video saliency: Augmenting image saliency with dynamic attentional push. In *The IEEE Conference on Computer Vision and Pattern Recognition (CVPR)*, June 2018.
- Mengran Gou, Fei Xiong, Octavia Camps, and Mario Sznaier. Monet: Moments embedding network. In *The IEEE Conference on Computer Vision and Pattern Recognition (CVPR)*, June 2018.
- Yash Goyal, Tejas Khot, Douglas Summers-Stay, Dhruv Batra, and Devi Parikh. Making the v in vqa matter: Elevating the role of image understanding in visual question answering. In *The IEEE Conference on Computer Vision and Pattern Recognition (CVPR)*, July 2017.
- Alexander Grabner, Peter M. Roth, and Vincent Lepetit. 3d pose estimation and 3d model retrieval for objects in the wild. In *The IEEE Conference on Computer Vision and Pattern Recognition (CVPR)*, June 2018.
- Benjamin Graham, Martin Engelcke, and Laurens van der Maaten. 3d semantic segmentation with submanifold sparse convolutional networks. In *The IEEE Conference on Computer Vision and Pattern Recognition (CVPR)*, June 2018.
- Brent A. Griffin and Jason J. Corso. Bubblesets: Learning to select the guidance frame in video object segmentation by deep sorting frames. In *The IEEE Conference on Computer Vision and Pattern Recognition (CVPR)*, June 2019.
- Artur Grigorev, Artem Sevastopolsky, Alexander Vakhitov, and Victor Lempitsky. Coordinate-based texture inpainting for pose-guided human image generation. In *The IEEE Conference on Computer Vision and Pattern Recognition (CVPR)*, June 2019.
- Sam Gross, Marc’Aurelio Ranzato, and Arthur Szlam. Hard mixtures of experts for large scale weakly supervised vision. In *The IEEE Conference on Computer Vision and Pattern Recognition (CVPR)*, July 2017.

- Thibault Groueix, Matthew Fisher, Vladimir G. Kim, Bryan C. Russell, and Mathieu Aubry. A papier-mâché approach to learning 3d surface generation. In *The IEEE Conference on Computer Vision and Pattern Recognition (CVPR)*, June 2018.
- Chunhui Gu, Chen Sun, David A. Ross, Carl Vondrick, Caroline Pantofaru, Yeqing Li, Sudheendra Vijayanarasimhan, George Toderici, Susanna Ricco, Rahul Sukthankar, Cordelia Schmid, and Jitendra Malik. Ava: A video dataset of spatio-temporally localized atomic visual actions. In *The IEEE Conference on Computer Vision and Pattern Recognition (CVPR)*, June 2018.
- Jinjin Gu, Hannan Lu, Wangmeng Zuo, and Chao Dong. Blind super-resolution with iterative kernel correction. In *The IEEE Conference on Computer Vision and Pattern Recognition (CVPR)*, June 2019.
- Jinwei Gu, Xiaodong Yang, Shalini De Mello, and Jan Kautz. Dynamic facial analysis: From bayesian filtering to recurrent neural network. In *The IEEE Conference on Computer Vision and Pattern Recognition (CVPR)*, July 2017.
- Hao Guan and William A. P. Smith. Brisks: Binary features for spherical images on a geodesic grid. In *The IEEE Conference on Computer Vision and Pattern Recognition (CVPR)*, July 2017.
- Riza Alp Guler and Iasonas Kokkinos. Holopose: Holistic 3d human reconstruction in-the-wild. In *The IEEE Conference on Computer Vision and Pattern Recognition (CVPR)*, June 2019.
- Hao Guo, Kang Zheng, Xiaochuan Fan, Hongkai Yu, and Song Wang. Visual attention consistency under image transforms for multi-label image classification. In *The IEEE Conference on Computer Vision and Pattern Recognition (CVPR)*, June 2019.
- Jun Guo and Hongyang Chao. One-to-many network for visually pleasing compression artifacts reduction. In *The IEEE Conference on Computer Vision and Pattern Recognition (CVPR)*, July 2017.
- Yiluan Guo and Ngai-Man Cheung. Efficient and deep person re-identification using multi-level similarity. In *The IEEE Conference on Computer Vision and Pattern Recognition (CVPR)*, June 2018.
- Agrim Gupta, Justin Johnson, Li Fei-Fei, Silvio Savarese, and Alexandre Alahi. Social gan: Socially acceptable trajectories with generative adversarial networks. In *The IEEE Conference on Computer Vision and Pattern Recognition (CVPR)*, June 2018.
- Agrim Gupta, Piotr Dollar, and Ross Girshick. Lvis: A dataset for large vocabulary instance segmentation. In *The IEEE Conference on Computer Vision and Pattern Recognition (CVPR)*, June 2019.
- Ankush Gupta, Andrea Vedaldi, and Andrew Zisserman. Synthetic data for text localisation in natural images. In *The IEEE Conference on Computer Vision and Pattern Recognition (CVPR)*, June 2016.
- Saurabh Gupta, James Davidson, Sergey Levine, Rahul Sukthankar, and Jitendra Malik. Cognitive mapping and planning for visual navigation. In *The IEEE Conference on Computer Vision and Pattern Recognition (CVPR)*, July 2017.
- Shir Gur and Lior Wolf. Single image depth estimation trained via depth from defocus cues. In *The IEEE Conference on Computer Vision and Pattern Recognition (CVPR)*, June 2019.
- Danna Gurari, Suyog Jain, Margrit Betke, and Kristen Grauman. Pull the plug? predicting if computers or humans should segment images. In *The IEEE Conference on Computer Vision and Pattern Recognition (CVPR)*, June 2016.
- Danna Gurari, Qing Li, Abigale J. Stangl, Anhong Guo, Chi Lin, Kristen Grauman, Jiebo Luo, and Jeffrey P. Bigham. Vizwiz grand challenge: Answering visual questions from blind people. In *The IEEE Conference on Computer Vision and Pattern Recognition (CVPR)*, June 2018.

- Danna Gurari, Qing Li, Chi Lin, Yinan Zhao, Anhong Guo, Abigale Stangl, and Jeffrey P. Bigham. Vizwiz-priv: A dataset for recognizing the presence and purpose of private visual information in images taken by blind people. In *The IEEE Conference on Computer Vision and Pattern Recognition (CVPR)*, June 2019.
- Swaminathan Gurumurthy, Ravi Kiran Sarvadevabhatla, and R. Venkatesh Babu. Deligan : Generative adversarial networks for diverse and limited data. In *The IEEE Conference on Computer Vision and Pattern Recognition (CVPR)*, July 2017.
- Felipe Gutierrez-Barragan, Syed Azer Reza, Andreas Velten, and Mohit Gupta. Practical coding function design for time-of-flight imaging. In *The IEEE Conference on Computer Vision and Pattern Recognition (CVPR)*, June 2019.
- Michael Gygli and Vittorio Ferrari. Fast object class labelling via speech. In *The IEEE Conference on Computer Vision and Pattern Recognition (CVPR)*, June 2019.
- Michael Gygli, Yale Song, and Liangliang Cao. Video2gif: Automatic generation of animated gifs from video. In *The IEEE Conference on Computer Vision and Pattern Recognition (CVPR)*, June 2016.
- Hyowon Ha, Sunghoon Im, Jaesik Park, Hae-Gon Jeon, and In So Kweon. High-quality depth from uncalibrated small motion clip. In *The IEEE Conference on Computer Vision and Pattern Recognition (CVPR)*, June 2016.
- Ikhsanul Habibie, Weipeng Xu, Dushyant Mehta, Gerard Pons-Moll, and Christian Theobalt. In the wild human pose estimation using explicit 2d features and intermediate 3d representations. In *The IEEE Conference on Computer Vision and Pattern Recognition (CVPR)*, June 2019.
- Timo Hackel, Jan D. Wegner, and Konrad Schindler. Contour detection in unstructured 3d point clouds. In *The IEEE Conference on Computer Vision and Pattern Recognition (CVPR)*, June 2016.
- Naama Hadad, Lior Wolf, and Moni Shahar. A two-step disentanglement method. In *The IEEE Conference on Computer Vision and Pattern Recognition (CVPR)*, June 2018.
- Benjamin D. Haeffele and Rene Vidal. Global optimality in neural network training. In *The IEEE Conference on Computer Vision and Pattern Recognition (CVPR)*, July 2017.
- Bjoern Haefner, Yvain Quéau, Thomas Möllenhoff, and Daniel Cremers. Fight ill-posedness with ill-posedness: Single-shot variational depth super-resolution from shading. In *The IEEE Conference on Computer Vision and Pattern Recognition (CVPR)*, June 2018.
- Daniel Haehn, Verena Kaynig, James Tompkin, Jeff W. Lichtman, and Hanspeter Pfister. Guided proofreading of automatic segmentations for connectomics. In *The IEEE Conference on Computer Vision and Pattern Recognition (CVPR)*, June 2018.
- Philip Haeusser, Alexander Mordvintsev, and Daniel Cremers. Learning by association – a versatile semi-supervised training method for neural networks. In *The IEEE Conference on Computer Vision and Pattern Recognition (CVPR)*, July 2017.
- Maciej Halber and Thomas Funkhouser. Fine-to-coarse global registration of rgb-d scans. In *The IEEE Conference on Computer Vision and Pattern Recognition (CVPR)*, July 2017.
- Oshri Halimi, Or Litany, Emanuele Rodola, Alex M. Bronstein, and Ron Kimmel. Unsupervised learning of dense shape correspondence. In *The IEEE Conference on Computer Vision and Pattern Recognition (CVPR)*, June 2019.
- Bumsub Ham, Minsu Cho, Cordelia Schmid, and Jean Ponce. Proposal flow. In *The IEEE Conference on Computer Vision and Pattern Recognition (CVPR)*, June 2016.
- Ryuhei Hamaguchi, Ken Sakurada, and Ryosuke Nakamura. Rare event detection using disentangled representation learning. In *The IEEE Conference on Computer Vision and Pattern Recognition (CVPR)*, June 2019.

- Seyed Hamid Rezatofghi, Anton Milan, Zhen Zhang, Qinfeng Shi, Anthony Dick, and Ian Reid. Joint probabilistic matching using m-best solutions. In *The IEEE Conference on Computer Vision and Pattern Recognition (CVPR)*, June 2016.
- Bohyung Han, Jack Sim, and Hartwig Adam. Branchout: Regularization for online ensemble tracking with convolutional neural networks. In *The IEEE Conference on Computer Vision and Pattern Recognition (CVPR)*, July 2017.
- Kai Han, Kwan-Yee K. Wong, Dirk Schnieders, and Miaomiao Liu. Mirror surface reconstruction under an uncalibrated camera. In *The IEEE Conference on Computer Vision and Pattern Recognition (CVPR)*, June 2016.
- Wei Han, Shiyu Chang, Ding Liu, Mo Yu, Michael Witbrock, and Thomas S. Huang. Image super-resolution via dual-state recurrent networks. In *The IEEE Conference on Computer Vision and Pattern Recognition (CVPR)*, June 2018.
- Xiaoguang Han, Zhaoxuan Zhang, Dong Du, Mingdai Yang, Jingming Yu, Pan Pan, Xin Yang, Ligang Liu, Zixiang Xiong, and Shuguang Cui. Deep reinforcement learning of volume-guided progressive view inpainting for 3d point scene completion from a single depth image. In *The IEEE Conference on Computer Vision and Pattern Recognition (CVPR)*, June 2019.
- Ankur Handa, Viorica Patraucean, Vijay Badrinarayanan, Simon Stent, and Roberto Cipolla. Understanding real world indoor scenes with synthetic data. In *The IEEE Conference on Computer Vision and Pattern Recognition (CVPR)*, June 2016.
- Zekun Hao, Yu Liu, Hongwei Qin, Junjie Yan, Xiu Li, and Xiaolin Hu. Scale-aware face detection. In *The IEEE Conference on Computer Vision and Pattern Recognition (CVPR)*, July 2017.
- Zekun Hao, Xun Huang, and Serge Belongie. Controllable video generation with sparse trajectories. In *The IEEE Conference on Computer Vision and Pattern Recognition (CVPR)*, June 2018.
- Nazim Haouchine and Stephane Cotin. Template-based monocular 3d recovery of elastic shapes using lagrangian multipliers. In *The IEEE Conference on Computer Vision and Pattern Recognition (CVPR)*, July 2017.
- Albert Haque, Alexandre Alahi, and Li Fei-Fei. Recurrent attention models for depth-based person identification. In *The IEEE Conference on Computer Vision and Pattern Recognition (CVPR)*, June 2016.
- Kensho Hara, Hirokatsu Kataoka, and Yutaka Satoh. Can spatiotemporal 3d cnns retrace the history of 2d cnns and imagenet? In *The IEEE Conference on Computer Vision and Pattern Recognition (CVPR)*, June 2018.
- Ali Harakeh, Daniel Asmar, and Elie Shammass. Identifying good training data for self-supervised free space estimation. In *The IEEE Conference on Computer Vision and Pattern Recognition (CVPR)*, June 2016.
- Mehrtash Harandi, Mathieu Salzmann, and Fatih Porikli. When vlad met hilbert. In *The IEEE Conference on Computer Vision and Pattern Recognition (CVPR)*, June 2016.
- Muhammad Haris, Gregory Shakhnarovich, and Norimichi Ukita. Deep back-projection networks for super-resolution. In *The IEEE Conference on Computer Vision and Pattern Recognition (CVPR)*, June 2018.
- Muhammad Haris, Gregory Shakhnarovich, and Norimichi Ukita. Recurrent back-projection network for video super-resolution. In *The IEEE Conference on Computer Vision and Pattern Recognition (CVPR)*, June 2019.
- Ben Harwood and Tom Drummond. Fanng: Fast approximate nearest neighbour graphs. In *The IEEE Conference on Computer Vision and Pattern Recognition (CVPR)*, June 2016.
- Irtiza Hasan, Francesco Setti, Theodore Tsesmelis, Alessio Del Bue, Fabio Galasso, and Marco Cristani. Mx-lstm: Mixing tracklets and vislets to jointly forecast trajectories and head poses. In *The IEEE Conference on Computer Vision and Pattern Recognition (CVPR)*, June 2018.

- Mahmudul Hasan, Jonghyun Choi, Jan Neumann, Amit K. Roy-Chowdhury, and Larry S. Davis. Learning temporal regularity in video sequences. In *The IEEE Conference on Computer Vision and Pattern Recognition (CVPR)*, June 2016.
- Tristan Hascoet, Yasuo Ariki, and Tetsuya Takiguchi. On zero-shot recognition of generic objects. In *The IEEE Conference on Computer Vision and Pattern Recognition (CVPR)*, June 2019.
- Yana Hasson, Gul Varol, Dimitrios Tzionas, Igor Kalevatykh, Michael J. Black, Ivan Laptev, and Cordelia Schmid. Learning joint reconstruction of hands and manipulated objects. In *The IEEE Conference on Computer Vision and Pattern Recognition (CVPR)*, June 2019.
- Monica Haurilet, Alina Roitberg, and Rainer Stiefelhagen. It’s not about the journey; it’s about the destination: Following soft paths under question-guidance for visual reasoning. In *The IEEE Conference on Computer Vision and Pattern Recognition (CVPR)*, June 2019.
- Manuel Haussmann, Fred A. Hamprecht, and Melih Kandemir. Variational bayesian multiple instance learning with gaussian processes. In *The IEEE Conference on Computer Vision and Pattern Recognition (CVPR)*, July 2017.
- Munawar Hayat, Salman H. Khan, Naoufel Werghi, and Roland Goecke. Joint registration and representation learning for unconstrained face identification. In *The IEEE Conference on Computer Vision and Pattern Recognition (CVPR)*, July 2017.
- Zeeshan Hayder, Xuming He, and Mathieu Salzmann. Learning to co-generate object proposals with a deep structured network. In *The IEEE Conference on Computer Vision and Pattern Recognition (CVPR)*, June 2016.
- Zeeshan Hayder, Xuming He, and Mathieu Salzmann. Boundary-aware instance segmentation. In *The IEEE Conference on Computer Vision and Pattern Recognition (CVPR)*, July 2017.
- Kaiming He, Xiangyu Zhang, Shaoqing Ren, and Jian Sun. Deep residual learning for image recognition. In *The IEEE Conference on Computer Vision and Pattern Recognition (CVPR)*, June 2016.
- Kun He, Yan Lu, and Stan Sclaroff. Local descriptors optimized for average precision. In *The IEEE Conference on Computer Vision and Pattern Recognition (CVPR)*, June 2018.
- Lifang He, Chun-Ta Lu, Hao Ding, Shen Wang, Linlin Shen, Philip S. Yu, and Ann B. Ragin. Multi-way multi-level kernel modeling for neuroimaging classification. In *The IEEE Conference on Computer Vision and Pattern Recognition (CVPR)*, July 2017.
- Tong He, Zhi Zhang, Hang Zhang, Zhongyue Zhang, Junyuan Xie, and Mu Li. Bag of tricks for image classification with convolutional neural networks. In *The IEEE Conference on Computer Vision and Pattern Recognition (CVPR)*, June 2019.
- Stefan Heber and Thomas Pock. Convolutional networks for shape from light field. In *The IEEE Conference on Computer Vision and Pattern Recognition (CVPR)*, June 2016.
- Eric Heim. Constrained generative adversarial networks for interactive image generation. In *The IEEE Conference on Computer Vision and Pattern Recognition (CVPR)*, June 2019.
- Matthias Hein, Maksym Andriushchenko, and Julian Bitterwolf. Why relu networks yield high-confidence predictions far away from the training data and how to mitigate the problem. In *The IEEE Conference on Computer Vision and Pattern Recognition (CVPR)*, June 2019.
- João F. Henriques and Andrea Vedaldi. Mapnet: An allocentric spatial memory for mapping environments. In *The IEEE Conference on Computer Vision and Pattern Recognition (CVPR)*, June 2018.
- Jae-Pil Heo, Zhe Lin, Xiaohui Shen, Jonathan Brandt, and Sung-eui Yoon. Shortlist selection with residual-aware distance estimator for k-nearest neighbor search. In *The IEEE Conference on Computer Vision and Pattern Recognition (CVPR)*, June 2016.
- Samitha Herath, Mehrtash Harandi, and Fatih Porikli. Learning an invariant hilbert space for domain adaptation. In *The IEEE Conference on Computer Vision and Pattern Recognition (CVPR)*, July 2017.

- Samitha Herath, Mehrtash Harandi, Basura Fernando, and Richard Nock. Min-max statistical alignment for transfer learning. In *The IEEE Conference on Computer Vision and Pattern Recognition (CVPR)*, June 2019.
- Luis Herranz, Shuqiang Jiang, and Xiangyang Li. Scene recognition with cnns: Objects, scales and dataset bias. In *The IEEE Conference on Computer Vision and Pattern Recognition (CVPR)*, June 2016.
- Amir Hertz, Sharon Fogel, Rana Hanocka, Raja Giryes, and Daniel Cohen-Or. Blind visual motif removal from a single image. In *The IEEE Conference on Computer Vision and Pattern Recognition (CVPR)*, June 2019.
- Chih-Hui Ho, Brandon Leung, Erik Sandstrom, Yen Chang, and Nuno Vasconcelos. Catastrophic child’s play: Easy to perform, hard to defend adversarial attacks. In *The IEEE Conference on Computer Vision and Pattern Recognition (CVPR)*, June 2019.
- Judy Hoffman, Saurabh Gupta, and Trevor Darrell. Learning with side information through modality hallucination. In *The IEEE Conference on Computer Vision and Pattern Recognition (CVPR)*, June 2016.
- Yannick Hold-Geoffroy, Kalyan Sunkavalli, Sunil Hadap, Emiliano Gambaretto, and Jean-Francois Lalonde. Deep outdoor illumination estimation. In *The IEEE Conference on Computer Vision and Pattern Recognition (CVPR)*, July 2017.
- Yannick Hold-Geoffroy, Kalyan Sunkavalli, Jonathan Eisenmann, Matthew Fisher, Emiliano Gambaretto, Sunil Hadap, and Jean-François Lalonde. A perceptual measure for deep single image camera calibration. In *The IEEE Conference on Computer Vision and Pattern Recognition (CVPR)*, June 2018.
- Yannick Hold-Geoffroy, Akshaya Athawale, and Jean-Francois Lalonde. Deep sky modeling for single image outdoor lighting estimation. In *The IEEE Conference on Computer Vision and Pattern Recognition (CVPR)*, June 2019.
- Namdar Homayounfar, Sanja Fidler, and Raquel Urtasun. Sports field localization via deep structured models. In *The IEEE Conference on Computer Vision and Pattern Recognition (CVPR)*, July 2017.
- Namdar Homayounfar, Wei-Chiu Ma, Shrinidhi Kowshika Lakshmikanth, and Raquel Urtasun. Hierarchical recurrent attention networks for structured online maps. In *The IEEE Conference on Computer Vision and Pattern Recognition (CVPR)*, June 2018.
- Sina Honari, Jason Yosinski, Pascal Vincent, and Christopher Pal. Recombinator networks: Learning coarse-to-fine feature aggregation. In *The IEEE Conference on Computer Vision and Pattern Recognition (CVPR)*, June 2016.
- Sina Honari, Pavlo Molchanov, Stephen Tyree, Pascal Vincent, Christopher Pal, and Jan Kautz. Improving landmark localization with semi-supervised learning. In *The IEEE Conference on Computer Vision and Pattern Recognition (CVPR)*, June 2018.
- Joey Hong, Benjamin Sapp, and James Philbin. Rules of the road: Predicting driving behavior with a convolutional model of semantic interactions. In *The IEEE Conference on Computer Vision and Pattern Recognition (CVPR)*, June 2019.
- Seunghoon Hong, Junhyuk Oh, Honglak Lee, and Bohyung Han. Learning transferrable knowledge for semantic segmentation with deep convolutional neural network. In *The IEEE Conference on Computer Vision and Pattern Recognition (CVPR)*, June 2016.
- Weixiang Hong, Zhenzhen Wang, Ming Yang, and Junsong Yuan. Conditional generative adversarial network for structured domain adaptation. In *The IEEE Conference on Computer Vision and Pattern Recognition (CVPR)*, June 2018.
- Ju Hong Yoon, Chang-Ryeol Lee, Ming-Hsuan Yang, and Kuk-Jin Yoon. Online multi-object tracking via structural constraint event aggregation. In *The IEEE Conference on Computer Vision and Pattern Recognition (CVPR)*, June 2016.

- Jan Hosang, Rodrigo Benenson, and Bernt Schiele. Learning non-maximum suppression. In *The IEEE Conference on Computer Vision and Pattern Recognition (CVPR)*, July 2017.
- Yedid Hoshen and Shmuel Peleg. An egocentric look at video photographer identity. In *The IEEE Conference on Computer Vision and Pattern Recognition (CVPR)*, June 2016.
- Yedid Hoshen and Lior Wolf. Unsupervised correlation analysis. In *The IEEE Conference on Computer Vision and Pattern Recognition (CVPR)*, June 2018.
- Yedid Hoshen, Ke Li, and Jitendra Malik. Non-adversarial image synthesis with generative latent nearest neighbors. In *The IEEE Conference on Computer Vision and Pattern Recognition (CVPR)*, June 2019.
- Mahdi S. Hosseini, Lyndon Chan, Gabriel Tse, Michael Tang, Jun Deng, Sajad Norouzi, Corwyn Rowsell, Konstantinos N. Plataniotis, and Savvas Damaskinos. Atlas of digital pathology: A generalized hierarchical histological tissue type-annotated database for deep learning. In *The IEEE Conference on Computer Vision and Pattern Recognition (CVPR)*, June 2019.
- Vlad Hosu, Bastian Goldlücke, and Dietmar Saupe. Effective aesthetics prediction with multi-level spatially pooled features. In *The IEEE Conference on Computer Vision and Pattern Recognition (CVPR)*, June 2019.
- Le Hou, Dimitris Samaras, Tahsin M. Kurc, Yi Gao, James E. Davis, and Joel H. Saltz. Patch-based convolutional neural network for whole slide tissue image classification. In *The IEEE Conference on Computer Vision and Pattern Recognition (CVPR)*, June 2016.
- Qibin Hou, Ming-Ming Cheng, Xiaowei Hu, Ali Borji, Zhuowen Tu, and Philip H. S. Torr. Deeply supervised salient object detection with short connections. In *The IEEE Conference on Computer Vision and Pattern Recognition (CVPR)*, July 2017.
- Saihui Hou, Xinyu Pan, Chen Change Loy, Zilei Wang, and Dahua Lin. Learning a unified classifier incrementally via rebalancing. In *The IEEE Conference on Computer Vision and Pattern Recognition (CVPR)*, June 2019.
- Wei-Lin Hsiao and Kristen Grauman. Creating capsule wardrobes from fashion images. In *The IEEE Conference on Computer Vision and Pattern Recognition (CVPR)*, June 2018.
- Kuang-Jui Hsu, Yen-Yu Lin, and Yung-Yu Chuang. Deepco3: Deep instance co-segmentation by co-peak search and co-saliency detection. In *The IEEE Conference on Computer Vision and Pattern Recognition (CVPR)*, June 2019.
- Ping Hu, Gang Wang, Xiangfei Kong, Jason Kuen, and Yap-Peng Tan. Motion-guided cascaded refinement network for video object segmentation. In *The IEEE Conference on Computer Vision and Pattern Recognition (CVPR)*, June 2018.
- Xuecai Hu, Haoyuan Mu, Xiangyu Zhang, Zilei Wang, Tieniu Tan, and Jian Sun. Meta-sr: A magnification-arbitrary network for super-resolution. In *The IEEE Conference on Computer Vision and Pattern Recognition (CVPR)*, June 2019.
- Yinlin Hu, Yunsong Li, and Rui Song. Robust interpolation of correspondences for large displacement optical flow. In *The IEEE Conference on Computer Vision and Pattern Recognition (CVPR)*, July 2017.
- Yuan-Ting Hu and Yen-Yu Lin. Progressive feature matching with alternate descriptor selection and correspondence enrichment. In *The IEEE Conference on Computer Vision and Pattern Recognition (CVPR)*, June 2016.
- Binh-Son Hua, Minh-Khoi Tran, and Sai-Kit Yeung. Pointwise convolutional neural networks. In *The IEEE Conference on Computer Vision and Pattern Recognition (CVPR)*, June 2018.
- Haozhi Huang, Hao Wang, Wenhan Luo, Lin Ma, Wenhao Jiang, Xiaolong Zhu, Zhifeng Li, and Wei Liu. Real-time neural style transfer for videos. In *The IEEE Conference on Computer Vision and Pattern Recognition (CVPR)*, July 2017.

- He Huang, Changhu Wang, Philip S. Yu, and Chang-Dong Wang. Generative dual adversarial network for generalized zero-shot learning. In *The IEEE Conference on Computer Vision and Pattern Recognition (CVPR)*, June 2019.
- Kun Huang, Yifan Wang, Zihan Zhou, Tianjiao Ding, Shenghua Gao, and Yi Ma. Learning to parse wireframes in images of man-made environments. In *The IEEE Conference on Computer Vision and Pattern Recognition (CVPR)*, June 2018.
- Shaoli Huang, Zhe Xu, Dacheng Tao, and Ya Zhang. Part-stacked cnn for fine-grained visual categorization. In *The IEEE Conference on Computer Vision and Pattern Recognition (CVPR)*, June 2016.
- Inbar Huberman and Raanan Fattal. Detecting repeating objects using patch correlation analysis. In *The IEEE Conference on Computer Vision and Pattern Recognition (CVPR)*, June 2016.
- Drew A. Hudson and Christopher D. Manning. Gqa: A new dataset for real-world visual reasoning and compositional question answering. In *The IEEE Conference on Computer Vision and Pattern Recognition (CVPR)*, June 2019.
- Minyoung Huh, Shao-Hua Sun, and Ning Zhang. Feedback adversarial learning: Spatial feedback for improving generative adversarial networks. In *The IEEE Conference on Computer Vision and Pattern Recognition (CVPR)*, June 2019.
- Zheng Hui, Xiumei Wang, and Xinbo Gao. Fast and accurate single image super-resolution via information distillation network. In *The IEEE Conference on Computer Vision and Pattern Recognition (CVPR)*, June 2018.
- Zhuo Hui, Ayan Chakrabarti, Kalyan Sunkavalli, and Aswin C. Sankaranarayanan. Learning to separate multiple illuminants in a single image. In *The IEEE Conference on Computer Vision and Pattern Recognition (CVPR)*, June 2019.
- Wei-Chih Hung, Varun Jampani, Sifei Liu, Pavlo Molchanov, Ming-Hsuan Yang, and Jan Kautz. Scops: Self-supervised co-part segmentation. In *The IEEE Conference on Computer Vision and Pattern Recognition (CVPR)*, June 2019.
- Junhwa Hur and Stefan Roth. Iterative residual refinement for joint optical flow and occlusion estimation. In *The IEEE Conference on Computer Vision and Pattern Recognition (CVPR)*, June 2019.
- Zaeem Hussain, Mingda Zhang, Xiaozhong Zhang, Keren Ye, Christopher Thomas, Zuha Agha, Nathan Ong, and Adriana Kovashka. Automatic understanding of image and video advertisements. In *The IEEE Conference on Computer Vision and Pattern Recognition (CVPR)*, July 2017.
- Noureddien Hussein, Efstratios Gavves, and Arnold W.M. Smeulders. Unified embedding and metric learning for zero-exemplar event detection. In *The IEEE Conference on Computer Vision and Pattern Recognition (CVPR)*, July 2017.
- Noureddien Hussein, Efstratios Gavves, and Arnold W.M. Smeulders. Timeception for complex action recognition. In *The IEEE Conference on Computer Vision and Pattern Recognition (CVPR)*, June 2019.
- Loc Huynh, Weikai Chen, Shunsuke Saito, Jun Xing, Koki Nagano, Andrew Jones, Paul Debevec, and Hao Li. Mesoscopic facial geometry inference using deep neural networks. In *The IEEE Conference on Computer Vision and Pattern Recognition (CVPR)*, June 2018.
- Jyh-Jing Hwang, Tsung-Wei Ke, Jianbo Shi, and Stella X. Yu. Adversarial structure matching for structured prediction tasks. In *The IEEE Conference on Computer Vision and Pattern Recognition (CVPR)*, June 2019.
- Je Hyeong Hong, Christopher Zach, and Andrew Fitzgibbon. Revisiting the variable projection method for separable nonlinear least squares problems. In *The IEEE Conference on Computer Vision and Pattern Recognition (CVPR)*, July 2017.

- Forrest N. Iandola, Matthew W. Moskewicz, Khalid Ashraf, and Kurt Keutzer. Firecaffe: Near-linear acceleration of deep neural network training on compute clusters. In *The IEEE Conference on Computer Vision and Pattern Recognition (CVPR)*, June 2016.
- Mostafa S. Ibrahim, Srikanth Muralidharan, Zhiwei Deng, Arash Vahdat, and Greg Mori. A hierarchical deep temporal model for group activity recognition. In *The IEEE Conference on Computer Vision and Pattern Recognition (CVPR)*, June 2016.
- Daiki Ikami, Toshihiko Yamasaki, and Kiyoharu Aizawa. Residual expansion algorithm: Fast and effective optimization for nonconvex least squares problems. In *The IEEE Conference on Computer Vision and Pattern Recognition (CVPR)*, July 2017.
- Daiki Ikami, Toshihiko Yamasaki, and Kiyoharu Aizawa. Local and global optimization techniques in graph-based clustering. In *The IEEE Conference on Computer Vision and Pattern Recognition (CVPR)*, June 2018.
- Eddy Ilg, Nikolaus Mayer, Tonmoy Saikia, Margret Keuper, Alexey Dosovitskiy, and Thomas Brox. FlowNet 2.0: Evolution of optical flow estimation with deep networks. In *The IEEE Conference on Computer Vision and Pattern Recognition (CVPR)*, July 2017.
- Sunghoon Im, Hae-Gon Jeon, and In So Kweon. Robust depth estimation from auto bracketed images. In *The IEEE Conference on Computer Vision and Pattern Recognition (CVPR)*, June 2018.
- Saif Imran, Yunfei Long, Xiaoming Liu, and Daniel Morris. Depth coefficients for depth completion. In *The IEEE Conference on Computer Vision and Pattern Recognition (CVPR)*, June 2019.
- Atul Ingle, Andreas Velten, and Mohit Gupta. High flux passive imaging with single-photon sensors. In *The IEEE Conference on Computer Vision and Pattern Recognition (CVPR)*, June 2019.
- Nathan Inkawhich, Wei Wen, Hai (Helen) Li, and Yiran Chen. Feature space perturbations yield more transferable adversarial examples. In *The IEEE Conference on Computer Vision and Pattern Recognition (CVPR)*, June 2019.
- Naoto Inoue, Ryosuke Furuta, Toshihiko Yamasaki, and Kiyoharu Aizawa. Cross-domain weakly-supervised object detection through progressive domain adaptation. In *The IEEE Conference on Computer Vision and Pattern Recognition (CVPR)*, June 2018.
- Eldar Insafutdinov, Mykhaylo Andriluka, Leonid Pishchulin, Siyu Tang, Evgeny Levinkov, Bjoern Andres, and Bernt Schiele. Arttrack: Articulated multi-person tracking in the wild. In *The IEEE Conference on Computer Vision and Pattern Recognition (CVPR)*, July 2017.
- Yani Ioannou, Duncan Robertson, Roberto Cipolla, and Antonio Criminisi. Deep roots: Improving cnn efficiency with hierarchical filter groups. In *The IEEE Conference on Computer Vision and Pattern Recognition (CVPR)*, July 2017.
- Radu Tudor Ionescu, Fahad Shahbaz Khan, Mariana-Iuliana Georgescu, and Ling Shao. Object-centric auto-encoders and dummy anomalies for abnormal event detection in video. In *The IEEE Conference on Computer Vision and Pattern Recognition (CVPR)*, June 2019.
- Umar Iqbal, Anton Milan, and Juergen Gall. PoseTrack: Joint multi-person pose estimation and tracking. In *The IEEE Conference on Computer Vision and Pattern Recognition (CVPR)*, July 2017.
- Hossam Isack, Olga Veksler, Milan Sonka, and Yuri Boykov. Hedgehog shape priors for multi-object segmentation. In *The IEEE Conference on Computer Vision and Pattern Recognition (CVPR)*, June 2016.
- Hossam Isack, Olga Veksler, Ipek Oguz, Milan Sonka, and Yuri Boykov. Efficient optimization for hierarchically-structured interacting segments (hints). In *The IEEE Conference on Computer Vision and Pattern Recognition (CVPR)*, July 2017.

- Ahmet Iscen, Michael Rabbat, and Teddy Furon. Efficient large-scale similarity search using matrix factorization. In *The IEEE Conference on Computer Vision and Pattern Recognition (CVPR)*, June 2016.
- Ahmet Iscen, Giorgos Tolias, Yannis Avrithis, Teddy Furon, and Ondrej Chum. Efficient diffusion on region manifolds: Recovering small objects with compact cnn representations. In *The IEEE Conference on Computer Vision and Pattern Recognition (CVPR)*, July 2017.
- Ahmet Iscen, Yannis Avrithis, Giorgos Tolias, Teddy Furon, and Ondřej Chum. Fast spectral ranking for similarity search. In *The IEEE Conference on Computer Vision and Pattern Recognition (CVPR)*, June 2018.
- Ahmet Iscen, Giorgos Tolias, Yannis Avrithis, and Ondrej Chum. Label propagation for deep semi-supervised learning. In *The IEEE Conference on Computer Vision and Pattern Recognition (CVPR)*, June 2019.
- Takahiro Isokane, Fumio Okura, Ayaka Ide, Yasuyuki Matsushita, and Yasushi Yagi. Probabilistic plant modeling via multi-view image-to-image translation. In *The IEEE Conference on Computer Vision and Pattern Recognition (CVPR)*, June 2018.
- Phillip Isola, Jun-Yan Zhu, Tinghui Zhou, and Alexei A. Efros. Image-to-image translation with conditional adversarial networks. In *The IEEE Conference on Computer Vision and Pattern Recognition (CVPR)*, July 2017.
- Vamsi K. Ithapu, Risi Kondor, Sterling C. Johnson, and Vikas Singh. The incremental multiresolution matrix factorization algorithm. In *The IEEE Conference on Computer Vision and Pattern Recognition (CVPR)*, July 2017.
- Eisuke Ito and Takayuki Okatani. Self-calibration-based approach to critical motion sequences of rolling-shutter structure from motion. In *The IEEE Conference on Computer Vision and Pattern Recognition (CVPR)*, July 2017.
- Mohit Iyyer, Varun Manjunatha, Anupam Guha, Yogarshi Vyas, Jordan Boyd-Graber, Hal Daume, III, and Larry S. Davis. The amazing mysteries of the gutter: Drawing inferences between panels in comic book narratives. In *The IEEE Conference on Computer Vision and Pattern Recognition (CVPR)*, July 2017.
- Hamid Izadinia, Qi Shan, and Steven M. Seitz. Im2cad. In *The IEEE Conference on Computer Vision and Pattern Recognition (CVPR)*, July 2017.
- Dominic Jack, Frederic Maire, Sareh Shirazi, and Anders Eriksson. Ige-net: Inverse graphics energy networks for human pose estimation and single-view reconstruction. In *The IEEE Conference on Computer Vision and Pattern Recognition (CVPR)*, June 2019.
- Benoit Jacob, Skirmantas Kligys, Bo Chen, Menglong Zhu, Matthew Tang, Andrew Howard, Hartwig Adam, and Dmitry Kalenichenko. Quantization and training of neural networks for efficient integer-arithmetic-only inference. In *The IEEE Conference on Computer Vision and Pattern Recognition (CVPR)*, June 2018.
- Jorn-Henrik Jacobsen, Jan van Gemert, Zhongyu Lou, and Arnold W. M. Smeulders. Structured receptive fields in cnns. In *The IEEE Conference on Computer Vision and Pattern Recognition (CVPR)*, June 2016.
- Seong Jae Hwang, Nagesh Adluru, Maxwell D. Collins, Sathya N. Ravi, Barbara B. Bendlin, Sterling C. Johnson, and Vikas Singh. Coupled harmonic bases for longitudinal characterization of brain networks. In *The IEEE Conference on Computer Vision and Pattern Recognition (CVPR)*, June 2016.
- Seong Jae Hwang, Sathya N. Ravi, Zirui Tao, Hyunwoo J. Kim, Maxwell D. Collins, and Vikas Singh. Tensorize, factorize and regularize: Robust visual relationship learning. In *The IEEE Conference on Computer Vision and Pattern Recognition (CVPR)*, June 2018.

- Mariano Jaimez, Thomas J. Cashman, Andrew Fitzgibbon, Javier Gonzalez-Jimenez, and Daniel Cremers. An efficient background term for 3d reconstruction and tracking with smooth surface models. In *The IEEE Conference on Computer Vision and Pattern Recognition (CVPR)*, July 2017.
- Himalaya Jain, Joaquin Zepeda, Patrick Pérez, and Rémi Gribonval. Learning a complete image indexing pipeline. In *The IEEE Conference on Computer Vision and Pattern Recognition (CVPR)*, June 2018.
- Unnat Jain, Luca Weihs, Eric Kolve, Mohammad Rastegari, Svetlana Lazebnik, Ali Farhadi, Alexander G. Schwing, and Aniruddha Kembhavi. Two body problem: Collaborative visual task completion. In *The IEEE Conference on Computer Vision and Pattern Recognition (CVPR)*, June 2019.
- Ayush Jaiswal, Yue Wu, Wael AbdAlmageed, Iacopo Masi, and Premkumar Natarajan. Aird: Adversarial learning framework for image repurposing detection. In *The IEEE Conference on Computer Vision and Pattern Recognition (CVPR)*, June 2019.
- Muhammad Abdullah Jamal and Guo-Jun Qi. Task agnostic meta-learning for few-shot learning. In *The IEEE Conference on Computer Vision and Pattern Recognition (CVPR)*, June 2019.
- Stephen James, Paul Wohlhart, Mrinal Kalakrishnan, Dmitry Kalashnikov, Alex Irpan, Julian Ibarz, Sergey Levine, Raia Hadsell, and Konstantinos Bousmalis. Sim-to-real via sim-to-sim: Data-efficient robotic grasping via randomized-to-canonical adaptation networks. In *The IEEE Conference on Computer Vision and Pattern Recognition (CVPR)*, June 2019.
- Varun Jampani, Martin Kiefel, and Peter V. Gehler. Learning sparse high dimensional filters: Image filtering, dense crfs and bilateral neural networks. In *The IEEE Conference on Computer Vision and Pattern Recognition (CVPR)*, June 2016.
- Varun Jampani, Raghudeep Gadde, and Peter V. Gehler. Video propagation networks. In *The IEEE Conference on Computer Vision and Pattern Recognition (CVPR)*, July 2017.
- Joel Janai, Fatma Guney, Jonas Wulff, Michael J. Black, and Andreas Geiger. Slow flow: Exploiting high-speed cameras for accurate and diverse optical flow reference data. In *The IEEE Conference on Computer Vision and Pattern Recognition (CVPR)*, July 2017.
- Won-Dong Jang and Chang-Su Kim. Interactive image segmentation via backpropagating refinement scheme. In *The IEEE Conference on Computer Vision and Pattern Recognition (CVPR)*, June 2019.
- Won-Dong Jang, Chulwoo Lee, and Chang-Su Kim. Primary object segmentation in videos via alternate convex optimization of foreground and background distributions. In *The IEEE Conference on Computer Vision and Pattern Recognition (CVPR)*, June 2016.
- Yunseok Jang, Yale Song, Youngjae Yu, Youngjin Kim, and Gunhee Kim. Tgif-qa: Toward spatio-temporal reasoning in visual question answering. In *The IEEE Conference on Computer Vision and Pattern Recognition (CVPR)*, July 2017.
- Dinesh Jayaraman and Kristen Grauman. Slow and steady feature analysis: Higher order temporal coherence in video. In *The IEEE Conference on Computer Vision and Pattern Recognition (CVPR)*, June 2016.
- Dinesh Jayaraman and Kristen Grauman. Learning to look around: Intelligently exploring unseen environments for unknown tasks. In *The IEEE Conference on Computer Vision and Pattern Recognition (CVPR)*, June 2018.
- Simon Jenni and Paolo Favaro. Self-supervised feature learning by learning to spot artifacts. In *The IEEE Conference on Computer Vision and Pattern Recognition (CVPR)*, June 2018.
- Simon Jenni and Paolo Favaro. On stabilizing generative adversarial training with noise. In *The IEEE Conference on Computer Vision and Pattern Recognition (CVPR)*, June 2019.

- Daniel S. Jeon, Seung-Hwan Baek, Inchang Choi, and Min H. Kim. Enhancing the spatial resolution of stereo images using a parallax prior. In *The IEEE Conference on Computer Vision and Pattern Recognition (CVPR)*, June 2018.
- Hae-Gon Jeon, Joon-Young Lee, Sunghoon Im, Hyowon Ha, and In So Kweon. Stereo matching with color and monochrome cameras in low-light conditions. In *The IEEE Conference on Computer Vision and Pattern Recognition (CVPR)*, June 2016.
- Yunho Jeon and Junmo Kim. Active convolution: Learning the shape of convolution for image classification. In *The IEEE Conference on Computer Vision and Pattern Recognition (CVPR)*, July 2017.
- Yeonwoo Jeong, Yoonsung Kim, and Hyun Oh Song. End-to-end efficient representation learning via cascading combinatorial optimization. In *The IEEE Conference on Computer Vision and Pattern Recognition (CVPR)*, June 2019.
- Saumya Jetley, Naila Murray, and Eleonora Vig. End-to-end saliency mapping via probability distribution prediction. In *The IEEE Conference on Computer Vision and Pattern Recognition (CVPR)*, June 2016.
- Saumya Jetley, Michael Sapienza, Stuart Golodetz, and Philip H. S. Torr. Straight to shapes: Real-time detection of encoded shapes. In *The IEEE Conference on Computer Vision and Pattern Recognition (CVPR)*, July 2017.
- Roy J. Jevnisek and Shai Avidan. Co-occurrence filter. In *The IEEE Conference on Computer Vision and Pattern Recognition (CVPR)*, July 2017.
- Dinghuang Ji, Junghyun Kwon, Max McFarland, and Silvio Savarese. Deep view morphing. In *The IEEE Conference on Computer Vision and Pattern Recognition (CVPR)*, July 2017.
- Pan Ji, Hongdong Li, Mathieu Salzmann, and Yiran Zhong. Robust multi-body feature tracker: A segmentation-free approach. In *The IEEE Conference on Computer Vision and Pattern Recognition (CVPR)*, June 2016.
- Kui Jia, Dacheng Tao, Shenghua Gao, and Xiangmin Xu. Improving training of deep neural networks via singular value bounding. In *The IEEE Conference on Computer Vision and Pattern Recognition (CVPR)*, July 2017.
- Songhao Jia, Ding-Jie Chen, and Hwann-Tzong Chen. Instance-level meta normalization. In *The IEEE Conference on Computer Vision and Pattern Recognition (CVPR)*, June 2019.
- Huaizu Jiang, Deqing Sun, Varun Jampani, Ming-Hsuan Yang, Erik Learned-Miller, and Jan Kautz. Super slo-mo: High quality estimation of multiple intermediate frames for video interpolation. In *The IEEE Conference on Computer Vision and Pattern Recognition (CVPR)*, June 2018.
- Qing-Yuan Jiang and Wu-Jun Li. Deep cross-modal hashing. In *The IEEE Conference on Computer Vision and Pattern Recognition (CVPR)*, July 2017.
- Xiaolong Jiang, Zehao Xiao, Baochang Zhang, Xiantong Zhen, Xianbin Cao, David Doermann, and Ling Shao. Crowd counting and density estimation by trellis encoder-decoder networks. In *The IEEE Conference on Computer Vision and Pattern Recognition (CVPR)*, June 2019.
- Jianbo Jiao, Yunchao Wei, Zequn Jie, Honghui Shi, Rynson W.H. Lau, and Thomas S. Huang. Geometry-aware distillation for indoor semantic segmentation. In *The IEEE Conference on Computer Vision and Pattern Recognition (CVPR)*, June 2019.
- Zequn Jie, Yunchao Wei, Xiaojie Jin, Jiashi Feng, and Wei Liu. Deep self-taught learning for weakly supervised object localization. In *The IEEE Conference on Computer Vision and Pattern Recognition (CVPR)*, July 2017.
- Zequn Jie, Pengfei Wang, Yonggen Ling, Bo Zhao, Yunchao Wei, Jiashi Feng, and Wei Liu. Left-right comparative recurrent model for stereo matching. In *The IEEE Conference on Computer Vision and Pattern Recognition (CVPR)*, June 2018.

- Meiguang Jin, Stefan Roth, and Paolo Favaro. Noise-blind image deblurring. In *The IEEE Conference on Computer Vision and Pattern Recognition (CVPR)*, July 2017.
- Meiguang Jin, Givi Meishvili, and Paolo Favaro. Learning to extract a video sequence from a single motion-blurred image. In *The IEEE Conference on Computer Vision and Pattern Recognition (CVPR)*, June 2018.
- Sheng Jin, Wentao Liu, Wanli Ouyang, and Chen Qian. Multi-person articulated tracking with spatial and temporal embeddings. In *The IEEE Conference on Computer Vision and Pattern Recognition (CVPR)*, June 2019.
- Younghyun Jo, Seoung Wug Oh, Jaeyeon Kang, and Seon Joo Kim. Deep video super-resolution network using dynamic upsampling filters without explicit motion compensation. In *The IEEE Conference on Computer Vision and Pattern Recognition (CVPR)*, June 2018.
- Ole Johannsen, Antonin Sulc, and Bastian Goldluecke. What sparse light field coding reveals about scene structure. In *The IEEE Conference on Computer Vision and Pattern Recognition (CVPR)*, June 2016.
- Joakim Johnander, Martin Danelljan, Emil Brissman, Fahad Shahbaz Khan, and Michael Felsberg. A generative appearance model for end-to-end video object segmentation. In *The IEEE Conference on Computer Vision and Pattern Recognition (CVPR)*, June 2019.
- Edward Johns, Stefan Leutenegger, and Andrew J. Davison. Pairwise decomposition of image sequences for active multi-view recognition. In *The IEEE Conference on Computer Vision and Pattern Recognition (CVPR)*, June 2016.
- Justin Johnson, Andrej Karpathy, and Li Fei-Fei. Denscap: Fully convolutional localization networks for dense captioning. In *The IEEE Conference on Computer Vision and Pattern Recognition (CVPR)*, June 2016.
- Justin Johnson, Bharath Hariharan, Laurens van der Maaten, Li Fei-Fei, C. Lawrence Zitnick, and Ross Girshick. Clevr: A diagnostic dataset for compositional language and elementary visual reasoning. In *The IEEE Conference on Computer Vision and Pattern Recognition (CVPR)*, July 2017.
- Justin Johnson, Agrim Gupta, and Li Fei-Fei. Image generation from scene graphs. In *The IEEE Conference on Computer Vision and Pattern Recognition (CVPR)*, June 2018.
- Nick Johnston, Damien Vincent, David Minnen, Michele Covell, Saurabh Singh, Troy Chinen, Sung Jin Hwang, Joel Shor, and George Toderici. Improved lossy image compression with priming and spatially adaptive bit rates for recurrent networks. In *The IEEE Conference on Computer Vision and Pattern Recognition (CVPR)*, June 2018.
- DongGyu Joo, Doyeon Kim, and Junmo Kim. Generating a fusion image: One’s identity and another’s shape. In *The IEEE Conference on Computer Vision and Pattern Recognition (CVPR)*, June 2018.
- Hanbyul Joo, Tomas Simon, Mina Cikara, and Yaser Sheikh. Towards social artificial intelligence: Nonverbal social signal prediction in a triadic interaction. In *The IEEE Conference on Computer Vision and Pattern Recognition (CVPR)*, June 2019.
- Kyungdon Joo, Tae-Hyun Oh, Junsik Kim, and In So Kweon. Globally optimal manhattan frame estimation in real-time. In *The IEEE Conference on Computer Vision and Pattern Recognition (CVPR)*, June 2016.
- Seong Joon Oh, Rodrigo Benenson, Anna Khoreva, Zeynep Akata, Mario Fritz, and Bernt Schiele. Exploiting saliency for object segmentation from image level labels. In *The IEEE Conference on Computer Vision and Pattern Recognition (CVPR)*, July 2017.
- David Joseph Tan, Thomas Cashman, Jonathan Taylor, Andrew Fitzgibbon, Daniel Tarlow, Sameh Khamis, Shahram Izadi, and Jamie Shotton. Fits like a glove: Rapid and reliable hand shape personalization. In *The IEEE Conference on Computer Vision and Pattern Recognition (CVPR)*, June 2016.

- Ajjen Joshi, Soumya Ghosh, Margrit Betke, Stan Sclaroff, and Hanspeter Pfister. Personalizing gesture recognition using hierarchical bayesian neural networks. In *The IEEE Conference on Computer Vision and Pattern Recognition (CVPR)*, July 2017.
- Amin Jourabloo and Xiaoming Liu. Large-pose face alignment via cnn-based dense 3d model fitting. In *The IEEE Conference on Computer Vision and Pattern Recognition (CVPR)*, June 2016.
- Fujiao Ju, Yanfeng Sun, Junbin Gao, Simeng Liu, Yongli Hu, and Baocai Yin. Mixture of bilateral-projection two-dimensional probabilistic principal component analysis. In *The IEEE Conference on Computer Vision and Pattern Recognition (CVPR)*, June 2016.
- Felix Juefei-Xu, Vishnu Naresh Boddeti, and Marios Savvides. Local binary convolutional neural networks. In *The IEEE Conference on Computer Vision and Pattern Recognition (CVPR)*, July 2017.
- Felix Juefei-Xu, Vishnu Naresh Boddeti, and Marios Savvides. Perturbative neural networks. In *The IEEE Conference on Computer Vision and Pattern Recognition (CVPR)*, June 2018.
- Florian Jug, Evgeny Levinkov, Corinna Blasse, Eugene W. Myers, and Bjoern Andres. Moral lineage tracing. In *The IEEE Conference on Computer Vision and Pattern Recognition (CVPR)*, June 2016.
- Yeong Jun Koh and Chang-Su Kim. Primary object segmentation in videos based on region augmentation and reduction. In *The IEEE Conference on Computer Vision and Pattern Recognition (CVPR)*, July 2017.
- Yeong Jun Koh, Won-Dong Jang, and Chang-Su Kim. Pod: Discovering primary objects in videos based on evolutionary refinement of object recurrence, background, and primary object models. In *The IEEE Conference on Computer Vision and Pattern Recognition (CVPR)*, June 2016.
- Jake Zhao (Junbo) and Kyunghyun Cho. Retrieval-augmented convolutional neural networks against adversarial examples. In *The IEEE Conference on Computer Vision and Pattern Recognition (CVPR)*, June 2019.
- Sangil Jung, Changyong Son, Seohyung Lee, Jinwoo Son, Jae-Joon Han, Youngjun Kwak, Sung Ju Hwang, and Changkyu Choi. Learning to quantize deep networks by optimizing quantization intervals with task loss. In *The IEEE Conference on Computer Vision and Pattern Recognition (CVPR)*, June 2019.
- Felix Järeemo Lawin, Martin Danelljan, Fahad Shahbaz Khan, Per-Erik Forssén, and Michael Felsberg. Density adaptive point set registration. In *The IEEE Conference on Computer Vision and Pattern Recognition (CVPR)*, June 2018.
- Achuta Kadambi, Jamie Schiel, and Ramesh Raskar. Macroscopic interferometry: Rethinking depth estimation with frequency-domain time-of-flight. In *The IEEE Conference on Computer Vision and Pattern Recognition (CVPR)*, June 2016.
- Kushal Kafle and Christopher Kanan. Answer-type prediction for visual question answering. In *The IEEE Conference on Computer Vision and Pattern Recognition (CVPR)*, June 2016.
- Kushal Kafle, Brian Price, Scott Cohen, and Christopher Kanan. Dvqa: Understanding data visualizations via question answering. In *The IEEE Conference on Computer Vision and Pattern Recognition (CVPR)*, June 2018.
- Mahdi M. Kalayeh, Boqing Gong, and Mubarak Shah. Improving facial attribute prediction using semantic segmentation. In *The IEEE Conference on Computer Vision and Pattern Recognition (CVPR)*, July 2017.
- Mahdi M. Kalayeh, Emrah Basaran, Muhittin Gökmen, Mustafa E. Kamasak, and Mubarak Shah. Human semantic parsing for person re-identification. In *The IEEE Conference on Computer Vision and Pattern Recognition (CVPR)*, June 2018.

- Evangelos Kalogerakis, Melinos Averkiou, Subhransu Maji, and Siddhartha Chaudhuri. 3d shape segmentation with projective convolutional networks. In *The IEEE Conference on Computer Vision and Pattern Recognition (CVPR)*, July 2017.
- Irene Kaltenmark, Benjamin Charlier, and Nicolas Charon. A general framework for curve and surface comparison and registration with oriented varifolds. In *The IEEE Conference on Computer Vision and Pattern Recognition (CVPR)*, July 2017.
- Michael Kampffmeyer, Yinbo Chen, Xiaodan Liang, Hao Wang, Yujia Zhang, and Eric P. Xing. Rethinking knowledge graph propagation for zero-shot learning. In *The IEEE Conference on Computer Vision and Pattern Recognition (CVPR)*, June 2019.
- Meina Kan, Shiguang Shan, and Xilin Chen. Multi-view deep network for cross-view classification. In *The IEEE Conference on Computer Vision and Pattern Recognition (CVPR)*, June 2016.
- Angjoo Kanazawa, David W. Jacobs, and Manmohan Chandraker. Warpnet: Weakly supervised matching for single-view reconstruction. In *The IEEE Conference on Computer Vision and Pattern Recognition (CVPR)*, June 2016.
- Angjoo Kanazawa, Michael J. Black, David W. Jacobs, and Jitendra Malik. End-to-end recovery of human shape and pose. In *The IEEE Conference on Computer Vision and Pattern Recognition (CVPR)*, June 2018.
- Angjoo Kanazawa, Jason Y. Zhang, Panna Felsen, and Jitendra Malik. Learning 3d human dynamics from video. In *The IEEE Conference on Computer Vision and Pattern Recognition (CVPR)*, June 2019.
- Can Kanbak, Seyed-Mohsen Moosavi-Dezfooli, and Pascal Frossard. Geometric robustness of deep networks: Analysis and improvement. In *The IEEE Conference on Computer Vision and Pattern Recognition (CVPR)*, June 2018.
- Atsushi Kanehira and Tatsuya Harada. Multi-label ranking from positive and unlabeled data. In *The IEEE Conference on Computer Vision and Pattern Recognition (CVPR)*, June 2016.
- Atsushi Kanehira, Luc Van Gool, Yoshitaka Ushiku, and Tatsuya Harada. Viewpoint-aware video summarization. In *The IEEE Conference on Computer Vision and Pattern Recognition (CVPR)*, June 2018.
- Atsushi Kanehira, Kentaro Takemoto, Sho Inayoshi, and Tatsuya Harada. Multimodal explanations by predicting counterfactuals in videos. In *The IEEE Conference on Computer Vision and Pattern Recognition (CVPR)*, June 2019.
- Takuhiro Kaneko, Kaoru Hiramatsu, and Kunio Kashino. Generative attribute controller with conditional filtered generative adversarial networks. In *The IEEE Conference on Computer Vision and Pattern Recognition (CVPR)*, July 2017.
- Takuhiro Kaneko, Kaoru Hiramatsu, and Kunio Kashino. Generative adversarial image synthesis with decision tree latent controller. In *The IEEE Conference on Computer Vision and Pattern Recognition (CVPR)*, June 2018.
- Takuhiro Kaneko, Yoshitaka Ushiku, and Tatsuya Harada. Label-noise robust generative adversarial networks. In *The IEEE Conference on Computer Vision and Pattern Recognition (CVPR)*, June 2019.
- Asako Kanezaki, Yasuyuki Matsushita, and Yoshifumi Nishida. Rotationnet: Joint object categorization and pose estimation using multiviews from unsupervised viewpoints. In *The IEEE Conference on Computer Vision and Pattern Recognition (CVPR)*, June 2018.
- Guoliang Kang, Lu Jiang, Yi Yang, and Alexander G. Hauptmann. Contrastive adaptation network for unsupervised domain adaptation. In *The IEEE Conference on Computer Vision and Pattern Recognition (CVPR)*, June 2019.

- Kai Kang, Wanli Ouyang, Hongsheng Li, and Xiaogang Wang. Object detection from video tubelets with convolutional neural networks. In *The IEEE Conference on Computer Vision and Pattern Recognition (CVPR)*, June 2016.
- Kai Kang, Hongsheng Li, Tong Xiao, Wanli Ouyang, Junjie Yan, Xihui Liu, and Xiaogang Wang. Object detection in videos with tubelet proposal networks. In *The IEEE Conference on Computer Vision and Pattern Recognition (CVPR)*, July 2017.
- Hariprasad Kannan, Nikos Komodakis, and Nikos Paragios. Newton-type methods for inference in higher-order markov random fields. In *The IEEE Conference on Computer Vision and Pattern Recognition (CVPR)*, July 2017.
- Amlan Kar, Nishant Rai, Karan Sikka, and Gaurav Sharma. Adascan: Adaptive scan pooling in deep convolutional neural networks for human action recognition in videos. In *The IEEE Conference on Computer Vision and Pattern Recognition (CVPR)*, July 2017.
- Nour Kaessli, Zeynep Akata, Bernt Schiele, and Andreas Bulling. Gaze embeddings for zero-shot image classification. In *The IEEE Conference on Computer Vision and Pattern Recognition (CVPR)*, July 2017.
- Nikolaos Karianakis, Jingming Dong, and Stefano Soatto. An empirical evaluation of current convolutional architectures' ability to manage nuisance location and scale variability. In *The IEEE Conference on Computer Vision and Pattern Recognition (CVPR)*, June 2016.
- Leonid Karlinsky, Joseph Shtok, Yochay Tzur, and Asaf Tzadok. Fine-grained recognition of thousands of object categories with single-example training. In *The IEEE Conference on Computer Vision and Pattern Recognition (CVPR)*, July 2017.
- Leonid Karlinsky, Joseph Shtok, Sivan Harary, Eli Schwartz, Amit Aides, Rogerio Feris, Raja Giryes, and Alex M. Bronstein. Repmet: Representative-based metric learning for classification and few-shot object detection. In *The IEEE Conference on Computer Vision and Pattern Recognition (CVPR)*, June 2019.
- Tero Karras, Samuli Laine, and Timo Aila. A style-based generator architecture for generative adversarial networks. In *The IEEE Conference on Computer Vision and Pattern Recognition (CVPR)*, June 2019.
- Ugur Kart, Alan Lukezic, Matej Kristan, Joni-Kristian Kamarainen, and Jiri Matas. Object tracking by reconstruction with view-specific discriminative correlation filters. In *The IEEE Conference on Computer Vision and Pattern Recognition (CVPR)*, June 2019.
- Yoni Kasten, Amnon Geifman, Meirav Galun, and Ronen Basri. Gpsfm: Global projective sfm using algebraic constraints on multi-view fundamental matrices. In *The IEEE Conference on Computer Vision and Pattern Recognition (CVPR)*, June 2019.
- Rotal Kat, Roy Jevnisek, and Shai Avidan. Matching pixels using co-occurrence statistics. In *The IEEE Conference on Computer Vision and Pattern Recognition (CVPR)*, June 2018.
- Hiroharu Kato and Tatsuya Harada. Learning view priors for single-view 3d reconstruction. In *The IEEE Conference on Computer Vision and Pattern Recognition (CVPR)*, June 2019.
- Hiroharu Kato, Yoshitaka Ushiku, and Tatsuya Harada. Neural 3d mesh renderer. In *The IEEE Conference on Computer Vision and Pattern Recognition (CVPR)*, June 2018.
- Hiroyuki Kayaba and Yuji Kokumai. Non-contact full field vibration measurement based on phase-shifting. In *The IEEE Conference on Computer Vision and Pattern Recognition (CVPR)*, July 2017.
- Liyiming Ke, Xiujun Li, Yonatan Bisk, Ari Holtzman, Zhe Gan, Jingjing Liu, Jianfeng Gao, Yejin Choi, and Siddhartha Srinivasa. Tactical rewind: Self-correction via backtracking in vision-and-language navigation. In *The IEEE Conference on Computer Vision and Pattern Recognition (CVPR)*, June 2019.

- Wei Ke, Jie Chen, Jianbin Jiao, Guoying Zhao, and Qixiang Ye. Srn: Side-output residual network for object symmetry detection in the wild. In *The IEEE Conference on Computer Vision and Pattern Recognition (CVPR)*, July 2017.
- Wadim Kehl, Federico Tombari, Slobodan Ilic, and Nassir Navab. Real-time 3d model tracking in color and depth on a single cpu core. In *The IEEE Conference on Computer Vision and Pattern Recognition (CVPR)*, July 2017.
- Michel Keller, Zetao Chen, Fabiola Maffra, Patrik Schmuck, and Margarita Chli. Learning deep descriptors with scale-aware triplet networks. In *The IEEE Conference on Computer Vision and Pattern Recognition (CVPR)*, June 2018.
- Aniruddha Kembhavi, Minjoon Seo, Dustin Schwenk, Jonghyun Choi, Ali Farhadi, and Hannaneh Hajishirzi. Are you smarter than a sixth grader? textbook question answering for multimodal machine comprehension. In *The IEEE Conference on Computer Vision and Pattern Recognition (CVPR)*, July 2017.
- Ira Kemelmacher-Shlizerman, Steven M. Seitz, Daniel Miller, and Evan Brossard. The megaface benchmark: 1 million faces for recognition at scale. In *The IEEE Conference on Computer Vision and Pattern Recognition (CVPR)*, June 2016.
- Alex Kendall and Roberto Cipolla. Geometric loss functions for camera pose regression with deep learning. In *The IEEE Conference on Computer Vision and Pattern Recognition (CVPR)*, July 2017.
- Alex Kendall, Yarin Gal, and Roberto Cipolla. Multi-task learning using uncertainty to weigh losses for scene geometry and semantics. In *The IEEE Conference on Computer Vision and Pattern Recognition (CVPR)*, June 2018.
- Rohit Keshari, Mayank Vatsa, Richa Singh, and Afzel Noore. Learning structure and strength of cnn filters for small sample size training. In *The IEEE Conference on Computer Vision and Pattern Recognition (CVPR)*, June 2018.
- Naemullah Khan and Ganesh Sundaramoorthi. Learned shape-tailored descriptors for segmentation. In *The IEEE Conference on Computer Vision and Pattern Recognition (CVPR)*, June 2018.
- Naemullah Khan, Byung-Woo Hong, Anthony Yezzi, and Ganesh Sundaramoorthi. Coarse-to-fine segmentation with shape-tailored continuum scale spaces. In *The IEEE Conference on Computer Vision and Pattern Recognition (CVPR)*, July 2017.
- Salman Khan, Munawar Hayat, Syed Waqas Zamir, Jianbing Shen, and Ling Shao. Striking the right balance with uncertainty. In *The IEEE Conference on Computer Vision and Pattern Recognition (CVPR)*, June 2019.
- Anna Khoreva, Rodrigo Benenson, Mohamed Omran, Matthias Hein, and Bernt Schiele. Weakly supervised object boundaries. In *The IEEE Conference on Computer Vision and Pattern Recognition (CVPR)*, June 2016.
- Anna Khoreva, Rodrigo Benenson, Jan Hosang, Matthias Hein, and Bernt Schiele. Simple does it: Weakly supervised instance and semantic segmentation. In *The IEEE Conference on Computer Vision and Pattern Recognition (CVPR)*, July 2017.
- Valentin Khrulkov and Ivan Oseledets. Art of singular vectors and universal adversarial perturbations. In *The IEEE Conference on Computer Vision and Pattern Recognition (CVPR)*, June 2018.
- D. Khue Le-Huu and Nikos Paragios. Alternating direction graph matching. In *The IEEE Conference on Computer Vision and Pattern Recognition (CVPR)*, July 2017.
- Yuka Kihara, Matvey Soloviev, and Tsuhan Chen. In the shadows, shape priors shine: Using occlusion to improve multi-region segmentation. In *The IEEE Conference on Computer Vision and Pattern Recognition (CVPR)*, June 2016.

- Edward Kim, Darryl Hannan, and Garrett Kenyon. Deep sparse coding for invariant multimodal halle berry neurons. In *The IEEE Conference on Computer Vision and Pattern Recognition (CVPR)*, June 2018.
- Jiwon Kim, Jung Kwon Lee, and Kyoung Mu Lee. Deeply-recursive convolutional network for image super-resolution. In *The IEEE Conference on Computer Vision and Pattern Recognition (CVPR)*, June 2016.
- Jongmin Kim, Taesup Kim, Sungwoong Kim, and Chang D. Yoo. Edge-labeling graph neural network for few-shot learning. In *The IEEE Conference on Computer Vision and Pattern Recognition (CVPR)*, June 2019.
- Jongyoo Kim and Sanghoon Lee. Deep learning of human visual sensitivity in image quality assessment framework. In *The IEEE Conference on Computer Vision and Pattern Recognition (CVPR)*, July 2017.
- Vamsi Kiran Adhikarla, Marek Vinkler, Denis Sumin, Rafal K. Mantiuk, Karol Myszkowski, Hans-Peter Seidel, and Piotr Didyk. Towards a quality metric for dense light fields. In *The IEEE Conference on Computer Vision and Pattern Recognition (CVPR)*, July 2017.
- Alexander Kirillov, Evgeny Levinkov, Bjoern Andres, Bogdan Savchynskyy, and Carsten Rother. Instancecut: From edges to instances with multicut. In *The IEEE Conference on Computer Vision and Pattern Recognition (CVPR)*, July 2017.
- Alexander Kirillov, Ross Girshick, Kaiming He, and Piotr Dollar. Panoptic feature pyramid networks. In *The IEEE Conference on Computer Vision and Pattern Recognition (CVPR)*, June 2019.
- Benjamin Klein and Lior Wolf. End-to-end supervised product quantization for image search and retrieval. In *The IEEE Conference on Computer Vision and Pattern Recognition (CVPR)*, June 2019.
- Netanel Kligler, Sagi Katz, and Ayellet Tal. Document enhancement using visibility detection. In *The IEEE Conference on Computer Vision and Pattern Recognition (CVPR)*, June 2018.
- Idan Kligvasser, Tamar Rott Shaham, and Tomer Michaeli. xunit: Learning a spatial activation function for efficient image restoration. In *The IEEE Conference on Computer Vision and Pattern Recognition (CVPR)*, June 2018.
- Patrick Knobelreiter, Christian Reinbacher, Alexander Shekhovtsov, and Thomas Pock. End-to-end training of hybrid cnn-crf models for stereo. In *The IEEE Conference on Computer Vision and Pattern Recognition (CVPR)*, July 2017.
- Takumi Kobayashi. Structured feature similarity with explicit feature map. In *The IEEE Conference on Computer Vision and Pattern Recognition (CVPR)*, June 2016.
- Takumi Kobayashi. Analyzing filters toward efficient convnet. In *The IEEE Conference on Computer Vision and Pattern Recognition (CVPR)*, June 2018.
- Muhammed Kocabas, Salih Karagoz, and Emre Akbas. Self-supervised learning of 3d human pose using multi-view geometry. In *The IEEE Conference on Computer Vision and Pattern Recognition (CVPR)*, June 2019.
- Sebastian Koch, Albert Matveev, Zhongshi Jiang, Francis Williams, Alexey Artemov, Evgeny Burnaev, Marc Alexa, Denis Zorin, and Daniele Panozzo. Abc: A big cad model dataset for geometric deep learning. In *The IEEE Conference on Computer Vision and Pattern Recognition (CVPR)*, June 2019.
- Elyor Kodirov, Tao Xiang, and Shaogang Gong. Semantic autoencoder for zero-shot learning. In *The IEEE Conference on Computer Vision and Pattern Recognition (CVPR)*, July 2017.
- Filippos Kokkinos and Stamatis Lefkimmiatis. Iterative residual cnns for burst photography applications. In *The IEEE Conference on Computer Vision and Pattern Recognition (CVPR)*, June 2019.

- Iasonas Kokkinos. Ubernet: Training a universal convolutional neural network for low-, mid-, and high-level vision using diverse datasets and limited memory. In *The IEEE Conference on Computer Vision and Pattern Recognition (CVPR)*, July 2017.
- Amir Kolaman, Maxim Lvov, Rami Hagege, and Hugo Guterman. Amplitude modulated video camera - light separation in dynamic scenes. In *The IEEE Conference on Computer Vision and Pattern Recognition (CVPR)*, June 2016.
- Alexander Kolesnikov, Xiaohua Zhai, and Lucas Beyer. Revisiting self-supervised visual representation learning. In *The IEEE Conference on Computer Vision and Pattern Recognition (CVPR)*, June 2019.
- Nicholas Kolkin, Jason Salavon, and Gregory Shakhnarovich. Style transfer by relaxed optimal transport and self-similarity. In *The IEEE Conference on Computer Vision and Pattern Recognition (CVPR)*, June 2019.
- Oscar Koller, Hermann Ney, and Richard Bowden. Deep hand: How to train a cnn on 1 million hand images when your data is continuous and weakly labelled. In *The IEEE Conference on Computer Vision and Pattern Recognition (CVPR)*, June 2016.
- Oscar Koller, Sepehr Zargaran, and Hermann Ney. Re-sign: Re-aligned end-to-end sequence modelling with deep recurrent cnn-hmms. In *The IEEE Conference on Computer Vision and Pattern Recognition (CVPR)*, July 2017.
- Nikos Kolotouros, Georgios Pavlakos, and Kostas Daniilidis. Convolutional mesh regression for single-image human shape reconstruction. In *The IEEE Conference on Computer Vision and Pattern Recognition (CVPR)*, June 2019.
- Soheil Kolouri, Yang Zou, and Gustavo K. Rohde. Sliced wasserstein kernels for probability distributions. In *The IEEE Conference on Computer Vision and Pattern Recognition (CVPR)*, June 2016.
- Soheil Kolouri, Gustavo K. Rohde, and Heiko Hoffmann. Sliced wasserstein distance for learning gaussian mixture models. In *The IEEE Conference on Computer Vision and Pattern Recognition (CVPR)*, June 2018.
- Artem Komarichev, Zichun Zhong, and Jing Hua. A-cnn: Annularly convolutional neural networks on point clouds. In *The IEEE Conference on Computer Vision and Pattern Recognition (CVPR)*, June 2019.
- Shu Kong and Charless Fowlkes. Low-rank bilinear pooling for fine-grained classification. In *The IEEE Conference on Computer Vision and Pattern Recognition (CVPR)*, July 2017.
- Shu Kong and Charless C. Fowlkes. Recurrent scene parsing with perspective understanding in the loop. In *The IEEE Conference on Computer Vision and Pattern Recognition (CVPR)*, June 2018.
- Tao Kong, Anbang Yao, Yurong Chen, and Fuchun Sun. Hypernet: Towards accurate region proposal generation and joint object detection. In *The IEEE Conference on Computer Vision and Pattern Recognition (CVPR)*, June 2016.
- Piotr Koniusz and Anoop Cherian. Sparse coding for third-order super-symmetric tensor descriptors with application to texture recognition. In *The IEEE Conference on Computer Vision and Pattern Recognition (CVPR)*, June 2016.
- Piotr Koniusz, Yusuf Tas, and Fatih Porikli. Domain adaptation by mixture of alignments of second- or higher-order scatter tensors. In *The IEEE Conference on Computer Vision and Pattern Recognition (CVPR)*, July 2017.
- Piotr Koniusz, Hongguang Zhang, and Fatih Porikli. A deeper look at power normalizations. In *The IEEE Conference on Computer Vision and Pattern Recognition (CVPR)*, June 2018.
- Theodora Kontogianni, Markus Mathias, and Bastian Leibe. Incremental object discovery in time-varying image collections. In *The IEEE Conference on Computer Vision and Pattern Recognition (CVPR)*, June 2016.

- Ksenia Konyushkova, Jasper Uijlings, Christoph H. Lampert, and Vittorio Ferrari. Learning intelligent dialogs for bounding box annotation. In *The IEEE Conference on Computer Vision and Pattern Recognition (CVPR)*, June 2018.
- Jari Korhonen. Assessing personally perceived image quality via image features and collaborative filtering. In *The IEEE Conference on Computer Vision and Pattern Recognition (CVPR)*, June 2019.
- Simon Korman, Mark Milam, and Stefano Soatto. Oatm: Occlusion aware template matching by consensus set maximization. In *The IEEE Conference on Computer Vision and Pattern Recognition (CVPR)*, June 2018.
- Simon Kornblith, Jonathon Shlens, and Quoc V. Le. Do better imagenet models transfer better? In *The IEEE Conference on Computer Vision and Pattern Recognition (CVPR)*, June 2019.
- Adam Kortylewski, Aleksander Wieczorek, Mario Wieser, Clemens Blumer, Sonali Parbhoo, Andreas Morel-Forster, Volker Roth, and Thomas Vetter. Greedy structure learning of hierarchical compositional models. In *The IEEE Conference on Computer Vision and Pattern Recognition (CVPR)*, June 2019.
- Pawel Korus and Nasir Memon. Content authentication for neural imaging pipelines: End-to-end optimization of photo provenance in complex distribution channels. In *The IEEE Conference on Computer Vision and Pattern Recognition (CVPR)*, June 2019.
- Jean Kossaifi, Linh Tran, Yannis Panagakis, and Maja Pantic. Gagan: Geometry-aware generative adversarial networks. In *The IEEE Conference on Computer Vision and Pattern Recognition (CVPR)*, June 2018.
- Jean Kossaifi, Adrian Bulat, Georgios Tzimiropoulos, and Maja Pantic. T-net: Parametrizing fully convolutional nets with a single high-order tensor. In *The IEEE Conference on Computer Vision and Pattern Recognition (CVPR)*, June 2019.
- Ronak Kosti, Jose M. Alvarez, Adria Recasens, and Agata Lapedriza. Emotion recognition in context. In *The IEEE Conference on Computer Vision and Pattern Recognition (CVPR)*, July 2017.
- Ilya Kostrikov, Zhongshi Jiang, Daniele Panozzo, Denis Zorin, and Joan Bruna. Surface networks. In *The IEEE Conference on Computer Vision and Pattern Recognition (CVPR)*, June 2018.
- Manikanta Kotaru and Sachin Katti. Position tracking for virtual reality using commodity wifi. In *The IEEE Conference on Computer Vision and Pattern Recognition (CVPR)*, July 2017.
- Dmytro Kotovenko, Artsiom Sanakoyeu, Pingchuan Ma, Sabine Lang, and Bjorn Ommer. A content transformation block for image style transfer. In *The IEEE Conference on Computer Vision and Pattern Recognition (CVPR)*, June 2019.
- Satwik Kottur, Ramakrishna Vedantam, Jose M. F. Moura, and Devi Parikh. Visual word2vec (vis-w2v): Learning visually grounded word embeddings using abstract scenes. In *The IEEE Conference on Computer Vision and Pattern Recognition (CVPR)*, June 2016.
- Balazs Kovacs, Sean Bell, Noah Snavely, and Kavita Bala. Shading annotations in the wild. In *The IEEE Conference on Computer Vision and Pattern Recognition (CVPR)*, July 2017.
- Koji Koyamatsu, Daichi Hidaka, Takahiro Okabe, and Hendrik P. A. Lensch. Reflective and fluorescent separation under narrow-band illumination. In *The IEEE Conference on Computer Vision and Pattern Recognition (CVPR)*, June 2019.
- Jedrzej Kozerawski and Matthew Turk. Clear: Cumulative learning for one-shot one-class image recognition. In *The IEEE Conference on Computer Vision and Pattern Recognition (CVPR)*, June 2018.
- Kyle Krafka, Aditya Khosla, Petr Kellnhofer, Harini Kannan, Suchendra Bhandarkar, Wojciech Matusik, and Antonio Torralba. Eye tracking for everyone. In *The IEEE Conference on Computer Vision and Pattern Recognition (CVPR)*, June 2016.

- Jonathan Krause, Justin Johnson, Ranjay Krishna, and Li Fei-Fei. A hierarchical approach for generating descriptive image paragraphs. In *The IEEE Conference on Computer Vision and Pattern Recognition (CVPR)*, July 2017.
- Sven Kreiss, Lorenzo Bertoni, and Alexandre Alahi. Pifpaf: Composite fields for human pose estimation. In *The IEEE Conference on Computer Vision and Pattern Recognition (CVPR)*, June 2019.
- Ranjay Krishna, Ines Chami, Michael Bernstein, and Li Fei-Fei. Referring relationships. In *The IEEE Conference on Computer Vision and Pattern Recognition (CVPR)*, June 2018.
- Ranjay Krishna, Michael Bernstein, and Li Fei-Fei. Information maximizing visual question generation. In *The IEEE Conference on Computer Vision and Pattern Recognition (CVPR)*, June 2019.
- Alexander Krull, Eric Brachmann, Sebastian Nowozin, Frank Michel, Jamie Shotton, and Carsten Rother. Poseagent: Budget-constrained 6d object pose estimation via reinforcement learning. In *The IEEE Conference on Computer Vision and Pattern Recognition (CVPR)*, July 2017.
- Alexander Krull, Tim-Oliver Buchholz, and Florian Jug. Noise2void - learning denoising from single noisy images. In *The IEEE Conference on Computer Vision and Pattern Recognition (CVPR)*, June 2019.
- Srinivas S. S. Kruthiventi, Vennela Gudisa, Jaley H. Dholakiya, and R. Venkatesh Babu. Saliency unified: A deep architecture for simultaneous eye fixation prediction and salient object segmentation. In *The IEEE Conference on Computer Vision and Pattern Recognition (CVPR)*, June 2016.
- Jason Ku, Alex D. Pon, and Steven L. Waslander. Monocular 3d object detection leveraging accurate proposals and shape reconstruction. In *The IEEE Conference on Computer Vision and Pattern Recognition (CVPR)*, June 2019.
- Jason Kuen, Zhenhua Wang, and Gang Wang. Recurrent attentional networks for saliency detection. In *The IEEE Conference on Computer Vision and Pattern Recognition (CVPR)*, June 2016.
- Jason Kuen, Xiangfei Kong, Zhe Lin, Gang Wang, Jianxiong Yin, Simon See, and Yap-Peng Tan. Stochastic downsampling for cost-adjustable inference and improved regularization in convolutional networks. In *The IEEE Conference on Computer Vision and Pattern Recognition (CVPR)*, June 2018.
- Zuzana Kukelova and Viktor Larsson. Radial distortion triangulation. In *The IEEE Conference on Computer Vision and Pattern Recognition (CVPR)*, June 2019.
- Zuzana Kukelova, Jan Heller, and Andrew Fitzgibbon. Efficient intersection of three quadrics and applications in computer vision. In *The IEEE Conference on Computer Vision and Pattern Recognition (CVPR)*, June 2016.
- Zuzana Kukelova, Joe Kileel, Bernd Sturmfels, and Tomas Pajdla. A clever elimination strategy for efficient minimal solvers. In *The IEEE Conference on Computer Vision and Pattern Recognition (CVPR)*, July 2017.
- Anna Kukleva, Hilde Kuehne, Fadime Sener, and Jurgen Gall. Unsupervised learning of action classes with continuous temporal embedding. In *The IEEE Conference on Computer Vision and Pattern Recognition (CVPR)*, June 2019.
- Kuldeep Kulkarni, Suhas Lohit, Pavan Turaga, Ronan Kerviche, and Amit Ashok. Reconnet: Non-iterative reconstruction of images from compressively sensed measurements. In *The IEEE Conference on Computer Vision and Pattern Recognition (CVPR)*, June 2016.
- Suryansh Kumar. Jumping manifolds: Geometry aware dense non-rigid structure from motion. In *The IEEE Conference on Computer Vision and Pattern Recognition (CVPR)*, June 2019.
- Suryansh Kumar, Anoop Cherian, Yuchao Dai, and Hongdong Li. Scalable dense non-rigid structure-from-motion: A grassmannian perspective. In *The IEEE Conference on Computer Vision and Pattern Recognition (CVPR)*, June 2018.

- Vijay Kumar, Anoop Namboodiri, Manohar Paluri, and C. V. Jawahar. Pose-aware person recognition. In *The IEEE Conference on Computer Vision and Pattern Recognition (CVPR)*, July 2017.
- Vijay Kumar B G, Gustavo Carneiro, and Ian Reid. Learning local image descriptors with deep siamese and triplet convolutional networks by minimising global loss functions. In *The IEEE Conference on Computer Vision and Pattern Recognition (CVPR)*, June 2016.
- Soumava Kumar Roy, Zakaria Mhammedi, and Mehrtash Harandi. Geometry aware constrained optimization techniques for deep learning. In *The IEEE Conference on Computer Vision and Pattern Recognition (CVPR)*, June 2018.
- Sudhakar Kumawat and Shanmuganathan Raman. Lp-3dcnn: Unveiling local phase in 3d convolutional neural networks. In *The IEEE Conference on Computer Vision and Pattern Recognition (CVPR)*, June 2019.
- Abhijit Kundu, Vibhav Vineet, and Vladlen Koltun. Feature space optimization for semantic video segmentation. In *The IEEE Conference on Computer Vision and Pattern Recognition (CVPR)*, June 2016.
- Orest Kupyn, Volodymyr Budzan, Mykola Mykhailych, Dmytro Mishkin, and Jiří Matas. Deblurgan: Blind motion deblurring using conditional adversarial networks. In *The IEEE Conference on Computer Vision and Pattern Recognition (CVPR)*, June 2018.
- Vinod Kumar Kurmi, Shanu Kumar, and Vinay P. Namboodiri. Attending to discriminative certainty for domain adaptation. In *The IEEE Conference on Computer Vision and Pattern Recognition (CVPR)*, June 2019.
- Ilja Kuzborskij, Fabio Maria Carlucci, and Barbara Caputo. When naive bayes nearest neighbors meet convolutional neural networks. In *The IEEE Conference on Computer Vision and Pattern Recognition (CVPR)*, June 2016.
- Yevhen Kuznietsov, Jorg Stuckler, and Bastian Leibe. Semi-supervised deep learning for monocular depth map prediction. In *The IEEE Conference on Computer Vision and Pattern Recognition (CVPR)*, July 2017.
- Suha Kwak, Minsu Cho, and Ivan Laptev. Thin-slicing for pose: Learning to understand pose without explicit pose estimation. In *The IEEE Conference on Computer Vision and Pattern Recognition (CVPR)*, June 2016.
- Roland Kwitt, Sebastian Hegenbart, and Marc Niethammer. One-shot learning of scene locations via feature trajectory transfer. In *The IEEE Conference on Computer Vision and Pattern Recognition (CVPR)*, June 2016.
- Yong-Hoon Kwon and Min-Gyu Park. Predicting future frames using retrospective cycle gan. In *The IEEE Conference on Computer Vision and Pattern Recognition (CVPR)*, June 2019.
- Zorah Lahner, Emanuele Rodola, Frank R. Schmidt, Michael M. Bronstein, and Daniel Cremers. Efficient globally optimal 2d-to-3d deformable shape matching. In *The IEEE Conference on Computer Vision and Pattern Recognition (CVPR)*, June 2016.
- Hsueh-Ying Lai, Yi-Hsuan Tsai, and Wei-Chen Chiu. Bridging stereo matching and optical flow via spatiotemporal correspondence. In *The IEEE Conference on Computer Vision and Pattern Recognition (CVPR)*, June 2019.
- Wei-Sheng Lai, Jia-Bin Huang, Zhe Hu, Narendra Ahuja, and Ming-Hsuan Yang. A comparative study for single image blind deblurring. In *The IEEE Conference on Computer Vision and Pattern Recognition (CVPR)*, June 2016.
- Wei-Sheng Lai, Jia-Bin Huang, Narendra Ahuja, and Ming-Hsuan Yang. Deep laplacian pyramid networks for fast and accurate super-resolution. In *The IEEE Conference on Computer Vision and Pattern Recognition (CVPR)*, July 2017.

- Rodney LaLonde, Dong Zhang, and Mubarak Shah. Clusternet: Detecting small objects in large scenes by exploiting spatio-temporal information. In *The IEEE Conference on Computer Vision and Pattern Recognition (CVPR)*, June 2018.
- Michael Lam, Behrooz Mahasseni, and Sinisa Todorovic. Fine-grained recognition as hsnet search for informative image parts. In *The IEEE Conference on Computer Vision and Pattern Recognition (CVPR)*, July 2017.
- John Lambert, Ozan Sener, and Silvio Savarese. Deep learning under privileged information using heteroscedastic dropout. In *The IEEE Conference on Computer Vision and Pattern Recognition (CVPR)*, June 2018.
- Shiyi Lan, Ruichi Yu, Gang Yu, and Larry S. Davis. Modeling local geometric structure of 3d point clouds using geo-cnn. In *The IEEE Conference on Computer Vision and Pattern Recognition (CVPR)*, June 2019.
- Ziquan Lan, David Hsu, and Gim Hee Lee. Solving the perspective-2-point problem for flying-camera photo composition. In *The IEEE Conference on Computer Vision and Pattern Recognition (CVPR)*, June 2018.
- Loic Landrieu and Mohamed Boussaha. Point cloud oversegmentation with graph-structured deep metric learning. In *The IEEE Conference on Computer Vision and Pattern Recognition (CVPR)*, June 2019.
- Loic Landrieu and Martin Simonovsky. Large-scale point cloud semantic segmentation with superpoint graphs. In *The IEEE Conference on Computer Vision and Pattern Recognition (CVPR)*, June 2018.
- Alex H. Lang, Sourabh Vora, Holger Caesar, Lubing Zhou, Jiong Yang, and Oscar Beijbom. Pointpillars: Fast encoders for object detection from point clouds. In *The IEEE Conference on Computer Vision and Pattern Recognition (CVPR)*, June 2019.
- Jan-Hendrik Lange, Bjoern Andres, and Paul Swoboda. Combinatorial persistency criteria for multicut and max-cut. In *The IEEE Conference on Computer Vision and Pattern Recognition (CVPR)*, June 2019.
- Dong Lao and Ganesh Sundaramoorthi. Minimum delay moving object detection. In *The IEEE Conference on Computer Vision and Pattern Recognition (CVPR)*, July 2017.
- Yizhen Lao and Omar Ait-Aider. A robust method for strong rolling shutter effects correction using lines with automatic feature selection. In *The IEEE Conference on Computer Vision and Pattern Recognition (CVPR)*, June 2018.
- Maksim Lapin, Matthias Hein, and Bernt Schiele. Loss functions for top-k error: Analysis and insights. In *The IEEE Conference on Computer Vision and Pattern Recognition (CVPR)*, June 2016.
- Dmitry Laptev, Nikolay Savinov, Joachim M. Buhmann, and Marc Pollefeys. Ti-pooling: Transformation-invariant pooling for feature learning in convolutional neural networks. In *The IEEE Conference on Computer Vision and Pattern Recognition (CVPR)*, June 2016.
- Sebastian Latuschkin, Alexander Binder, Gregoire Montavon, Klaus-Robert Muller, and Wojciech Samek. Analyzing classifiers: Fisher vectors and deep neural networks. In *The IEEE Conference on Computer Vision and Pattern Recognition (CVPR)*, June 2016.
- Mans Larsson, Erik Stenborg, Lars Hammarstrand, Marc Pollefeys, Torsten Sattler, and Fredrik Kahl. A cross-season correspondence dataset for robust semantic segmentation. In *The IEEE Conference on Computer Vision and Pattern Recognition (CVPR)*, June 2019.
- Viktor Larsson and Carl Olsson. Compact matrix factorization with dependent subspaces. In *The IEEE Conference on Computer Vision and Pattern Recognition (CVPR)*, July 2017.

- Viktor Larsson, Zuzana Kukelova, and Yinqiang Zheng. Camera pose estimation with unknown principal point. In *The IEEE Conference on Computer Vision and Pattern Recognition (CVPR)*, June 2018.
- Christoph Lassner, Javier Romero, Martin Kiefel, Federica Bogo, Michael J. Black, and Peter V. Gehler. Unite the people: Closing the loop between 3d and 2d human representations. In *The IEEE Conference on Computer Vision and Pattern Recognition (CVPR)*, July 2017.
- Stephane Lathuiliere, Remi Juge, Pablo Mesejo, Rafael Munoz-Salinas, and Radu Horaud. Deep mixture of linear inverse regressions applied to head-pose estimation. In *The IEEE Conference on Computer Vision and Pattern Recognition (CVPR)*, July 2017.
- Emanuel Laude, Jan-Hendrik Lange, Jonas Schüpfer, Csaba Domokos, Laura Leal-Taixé, Frank R. Schmidt, Bjoern Andres, and Daniel Cremers. Discrete-continuous admm for transductive inference in higher-order mrfs. In *The IEEE Conference on Computer Vision and Pattern Recognition (CVPR)*, June 2018.
- Andrew Lavin and Scott Gray. Fast algorithms for convolutional neural networks. In *The IEEE Conference on Computer Vision and Pattern Recognition (CVPR)*, June 2016.
- Marc T. Law, YaoLiang Yu, Matthieu Cord, and Eric P. Xing. Closed-form training of mahalanobis distance for supervised clustering. In *The IEEE Conference on Computer Vision and Pattern Recognition (CVPR)*, June 2016.
- Marc T. Law, Yaoliang Yu, Raquel Urtasun, Richard S. Zemel, and Eric P. Xing. Efficient multiple instance metric learning using weakly supervised data. In *The IEEE Conference on Computer Vision and Pattern Recognition (CVPR)*, July 2017.
- Huu Le, Tat-Jun Chin, and David Suter. Conformal surface alignment with optimal mobius search. In *The IEEE Conference on Computer Vision and Pattern Recognition (CVPR)*, June 2016.
- Huu Le, Tat-Jun Chin, and David Suter. An exact penalty method for locally convergent maximum consensus. In *The IEEE Conference on Computer Vision and Pattern Recognition (CVPR)*, July 2017.
- Huu M. Le, Thanh-Toan Do, Tuan Hoang, and Ngai-Man Cheung. Sdrsac: Semidefinite-based randomized approach for robust point cloud registration without correspondences. In *The IEEE Conference on Computer Vision and Pattern Recognition (CVPR)*, June 2019.
- Truc Le and Ye Duan. Pointgrid: A deep network for 3d shape understanding. In *The IEEE Conference on Computer Vision and Pattern Recognition (CVPR)*, June 2018.
- Colin Lea, Michael D. Flynn, Rene Vidal, Austin Reiter, and Gregory D. Hager. Temporal convolutional networks for action segmentation and detection. In *The IEEE Conference on Computer Vision and Pattern Recognition (CVPR)*, July 2017.
- Vadim Lebedev and Victor Lempitsky. Fast convnets using group-wise brain damage. In *The IEEE Conference on Computer Vision and Pattern Recognition (CVPR)*, June 2016.
- Christian Ledig, Lucas Theis, Ferenc Huszar, Jose Caballero, Andrew Cunningham, Alejandro Acosta, Andrew Aitken, Alykhan Tejani, Johannes Totz, Zehan Wang, and Wenzhe Shi. Photo-realistic single image super-resolution using a generative adversarial network. In *The IEEE Conference on Computer Vision and Pattern Recognition (CVPR)*, July 2017.
- Gayoung Lee, Yu-Wing Tai, and Junmo Kim. Deep saliency with encoded low level distance map and high level features. In *The IEEE Conference on Computer Vision and Pattern Recognition (CVPR)*, June 2016.
- Jae-Han Lee, Minhyeok Heo, Kyung-Rae Kim, and Chang-Su Kim. Single-image depth estimation based on fourier domain analysis. In *The IEEE Conference on Computer Vision and Pattern Recognition (CVPR)*, June 2018.

- Junghyup Lee, Dohyung Kim, Jean Ponce, and Bumsub Ham. Sfnets: Learning object-aware semantic correspondence. In *The IEEE Conference on Computer Vision and Pattern Recognition (CVPR)*, June 2019.
- Namhoon Lee, Wongun Choi, Paul Vernaza, Christopher B. Choy, Philip H. S. Torr, and Manmohan Chandraker. Desire: Distant future prediction in dynamic scenes with interacting agents. In *The IEEE Conference on Computer Vision and Pattern Recognition (CVPR)*, July 2017.
- Stamatios Lefkimmiatis. Non-local color image denoising with convolutional neural networks. In *The IEEE Conference on Computer Vision and Pattern Recognition (CVPR)*, July 2017.
- Stamatios Lefkimmiatis. Universal denoising networks : A novel cnn architecture for image denoising. In *The IEEE Conference on Computer Vision and Pattern Recognition (CVPR)*, June 2018.
- Chloe LeGendre, Wan-Chun Ma, Graham Fyffe, John Flynn, Laurent Charbonnel, Jay Busch, and Paul Debevec. Deeplight: Learning illumination for unconstrained mobile mixed reality. In *The IEEE Conference on Computer Vision and Pattern Recognition (CVPR)*, June 2019.
- Chenyang Lei and Qifeng Chen. Fully automatic video colorization with self-regularization and diversity. In *The IEEE Conference on Computer Vision and Pattern Recognition (CVPR)*, June 2019.
- Chenyi Lei, Dong Liu, Weiping Li, Zheng-Jun Zha, and Houqiang Li. Comparative deep learning of hybrid representations for image recommendations. In *The IEEE Conference on Computer Vision and Pattern Recognition (CVPR)*, June 2016.
- Peng Lei, Fuxin Li, and Sinisa Todorovic. Boundary flow: A siamese network that predicts boundary motion without training on motion. In *The IEEE Conference on Computer Vision and Pattern Recognition (CVPR)*, June 2018.
- Carl Lemaire, Andrew Achkar, and Pierre-Marc Jodoin. Structured pruning of neural networks with budget-aware regularization. In *The IEEE Conference on Computer Vision and Pattern Recognition (CVPR)*, June 2019.
- Evgeny Levinkov, Jonas Uhrig, Siyu Tang, Mohamed Omran, Eldar Insafutdinov, Alexander Kirillov, Carsten Rother, Thomas Brox, Bernt Schiele, and Bjoern Andres. Joint graph decomposition node labeling: Problem, algorithms, applications. In *The IEEE Conference on Computer Vision and Pattern Recognition (CVPR)*, July 2017.
- Aviad Levis, Yoav Y. Schechner, and Anthony B. Davis. Multiple-scattering microphysics tomography. In *The IEEE Conference on Computer Vision and Pattern Recognition (CVPR)*, July 2017.
- Aviad Levis, Yoav Y. Schechner, and Ronen Talmon. Statistical tomography of microscopic life. In *The IEEE Conference on Computer Vision and Pattern Recognition (CVPR)*, June 2018.
- Jose Lezama, Qiang Qiu, and Guillermo Sapiro. Not afraid of the dark: Nir-vis face recognition via cross-spectral hallucination and low-rank embedding. In *The IEEE Conference on Computer Vision and Pattern Recognition (CVPR)*, July 2017.
- José Lezama, Qiang Qiu, Pablo Musé, and Guillermo Sapiro. OIÉ: Orthogonal low-rank embedding - a plug and play geometric loss for deep learning. In *The IEEE Conference on Computer Vision and Pattern Recognition (CVPR)*, June 2018.
- Ang Li, Jin Sun, Joe Yue-Hei Ng, Ruichi Yu, Vlad I. Morariu, and Larry S. Davis. Generating holistic 3d scene abstractions for text-based image retrieval. In *The IEEE Conference on Computer Vision and Pattern Recognition (CVPR)*, July 2017.
- Guanbin Li and Yizhou Yu. Deep contrast learning for salient object detection. In *The IEEE Conference on Computer Vision and Pattern Recognition (CVPR)*, June 2016.
- Hongyang Li, David Eigen, Samuel Dodge, Matthew Zeiler, and Xiaogang Wang. Finding task-relevant features for few-shot learning by category traversal. In *The IEEE Conference on Computer Vision and Pattern Recognition (CVPR)*. June 2019.

- Shuang Li, Slawomir Bak, Peter Carr, and Xiaogang Wang. Diversity regularized spatiotemporal attention for video-based person re-identification. In *The IEEE Conference on Computer Vision and Pattern Recognition (CVPR)*, June 2018.
- Dongze Lian, Jing Li, Jia Zheng, Weixin Luo, and Shenghua Gao. Density map regression guided detection network for rgb-d crowd counting and localization. In *The IEEE Conference on Computer Vision and Pattern Recognition (CVPR)*, June 2019.
- Jian Liang, Ran He, Zhenan Sun, and Tieniu Tan. Distant supervised centroid shift: A simple and efficient approach to visual domain adaptation. In *The IEEE Conference on Computer Vision and Pattern Recognition (CVPR)*, June 2019.
- Xiaodan Liang, Yunchao Wei, Xiaohui Shen, Zequn Jie, Jiashi Feng, Liang Lin, and Shuicheng Yan. Reversible recursive instance-level object segmentation. In *The IEEE Conference on Computer Vision and Pattern Recognition (CVPR)*, June 2016.
- Xiaodan Liang, Lisa Lee, and Eric P. Xing. Deep variation-structured reinforcement learning for visual relationship and attribute detection. In *The IEEE Conference on Computer Vision and Pattern Recognition (CVPR)*, July 2017.
- Xiaodan Liang, Hongfei Zhou, and Eric Xing. Dynamic-structured semantic propagation network. In *The IEEE Conference on Computer Vision and Pattern Recognition (CVPR)*, June 2018.
- Fangzhou Liao, Ming Liang, Yinpeng Dong, Tianyu Pang, Xiaolin Hu, and Jun Zhu. Defense against adversarial attacks using high-level representation guided denoiser. In *The IEEE Conference on Computer Vision and Pattern Recognition (CVPR)*, June 2018.
- Yuan-Hong Liao, Xavier Puig, Marko Boben, Antonio Torralba, and Sanja Fidler. Synthesizing environment-aware activities via activity sketches. In *The IEEE Conference on Computer Vision and Pattern Recognition (CVPR)*, June 2019.
- Yann Lifchitz, Yannis Avrithis, Sylvaine Picard, and Andrei Bursuc. Dense classification and implanting for few-shot learning. In *The IEEE Conference on Computer Vision and Pattern Recognition (CVPR)*, June 2019.
- Ivan Lillo, Juan Carlos Niebles, and Alvaro Soto. A hierarchical pose-based approach to complex action understanding using dictionaries of actionlets and motion poselets. In *The IEEE Conference on Computer Vision and Pattern Recognition (CVPR)*, June 2016.
- Chen-Hsuan Lin, Oliver Wang, Bryan C. Russell, Eli Shechtman, Vladimir G. Kim, Matthew Fisher, and Simon Lucey. Photometric mesh optimization for video-aligned 3d object reconstruction. In *The IEEE Conference on Computer Vision and Pattern Recognition (CVPR)*, June 2019.
- Chung-Ching Lin and Ying Hung. A prior-less method for multi-face tracking in unconstrained videos. In *The IEEE Conference on Computer Vision and Pattern Recognition (CVPR)*, June 2018.
- Kevin Lin, Jiwen Lu, Chu-Song Chen, and Jie Zhou. Learning compact binary descriptors with unsupervised deep neural networks. In *The IEEE Conference on Computer Vision and Pattern Recognition (CVPR)*, June 2016.
- Mude Lin, Liang Lin, Xiaodan Liang, Keze Wang, and Hui Cheng. Recurrent 3d pose sequence machines. In *The IEEE Conference on Computer Vision and Pattern Recognition (CVPR)*, July 2017.
- David B. Lindell, Gordon Wetzstein, and Vladlen Koltun. Acoustic non-line-of-sight imaging. In *The IEEE Conference on Computer Vision and Pattern Recognition (CVPR)*, June 2019.
- Huan Ling, Jun Gao, Amlan Kar, Wenzheng Chen, and Sanja Fidler. Fast interactive object annotation with curve-gcn. In *The IEEE Conference on Computer Vision and Pattern Recognition (CVPR)*, June 2019.

- Or Litany, Alex Bronstein, Michael Bronstein, and Ameesh Makadia. Deformable shape completion with graph convolutional autoencoders. In *The IEEE Conference on Computer Vision and Pattern Recognition (CVPR)*, June 2018.
- Etai Littwin and Lior Wolf. The multiverse loss for robust transfer learning. In *The IEEE Conference on Computer Vision and Pattern Recognition (CVPR)*, June 2016.
- Chen Liu, Pushmeet Kohli, and Yasutaka Furukawa. Layered scene decomposition via the occlusion-crf. In *The IEEE Conference on Computer Vision and Pattern Recognition (CVPR)*, June 2016.
- Chenxi Liu, Liang-Chieh Chen, Florian Schroff, Hartwig Adam, Wei Hua, Alan L. Yuille, and Li Fei-Fei. Auto-deeplab: Hierarchical neural architecture search for semantic image segmentation. In *The IEEE Conference on Computer Vision and Pattern Recognition (CVPR)*, June 2019.
- Weiyang Liu, Yandong Wen, Zhiding Yu, Ming Li, Bhiksha Raj, and Le Song. Spheroface: Deep hypersphere embedding for face recognition. In *The IEEE Conference on Computer Vision and Pattern Recognition (CVPR)*, July 2017.
- Yaojie Liu, Amin Jourabloo, and Xiaoming Liu. Learning deep models for face anti-spoofing: Binary or auxiliary supervision. In *The IEEE Conference on Computer Vision and Pattern Recognition (CVPR)*, June 2018.
- Alex Locher, Michal Perdoch, and Luc Van Gool. Progressive prioritized multi-view stereo. In *The IEEE Conference on Computer Vision and Pattern Recognition (CVPR)*, June 2016.
- Fotios Logothetis, Roberto Mecca, and Roberto Cipolla. Semi-calibrated near field photometric stereo. In *The IEEE Conference on Computer Vision and Pattern Recognition (CVPR)*, July 2017.
- Suhas Lohit, Qiao Wang, and Pavan Turaga. Temporal transformer networks: Joint learning of invariant and discriminative time warping. In *The IEEE Conference on Computer Vision and Pattern Recognition (CVPR)*, June 2019.
- Chengjiang Long and Gang Hua. Correlational gaussian processes for cross-domain visual recognition. In *The IEEE Conference on Computer Vision and Pattern Recognition (CVPR)*, July 2017.
- Fuchen Long, Ting Yao, Zhaofan Qiu, Xinmei Tian, Jiebo Luo, and Tao Mei. Gaussian temporal awareness networks for action localization. In *The IEEE Conference on Computer Vision and Pattern Recognition (CVPR)*, June 2019.
- Xiang Long, Chuang Gan, Gerard de Melo, Jiajun Wu, Xiao Liu, and Shilei Wen. Attention clusters: Purely attention based local feature integration for video classification. In *The IEEE Conference on Computer Vision and Pattern Recognition (CVPR)*, June 2018.
- Manuel Lopez, Roger Mari, Pau Gargallo, Yubin Kuang, Javier Gonzalez-Jimenez, and Gloria Haro. Deep single image camera calibration with radial distortion. In *The IEEE Conference on Computer Vision and Pattern Recognition (CVPR)*, June 2019.
- David Lopez-Paz, Robert Nishihara, Soumith Chintala, Bernhard Scholkopf, and Leon Bottou. Discovering causal signals in images. In *The IEEE Conference on Computer Vision and Pattern Recognition (CVPR)*, July 2017.
- Dominik Lorenz, Leonard Bereska, Timo Milbich, and Bjorn Ommer. Unsupervised part-based disentangling of object shape and appearance. In *The IEEE Conference on Computer Vision and Pattern Recognition (CVPR)*, June 2019.
- Or Lotan and Michal Irani. Needle-match: Reliable patch matching under high uncertainty. In *The IEEE Conference on Computer Vision and Pattern Recognition (CVPR)*, June 2016.
- Yihang Lou, Yan Bai, Jun Liu, Shiqi Wang, and Lingyu Duan. Veri-wild: A large dataset and a new method for vehicle re-identification in the wild. In *The IEEE Conference on Computer Vision and Pattern Recognition (CVPR)*, June 2019.

- Cewu Lu, Hao Su, Yonglu Li, Yongyi Lu, Li Yi, Chi-Keung Tang, and Leonidas J. Guibas. Beyond holistic object recognition: Enriching image understanding with part states. In *The IEEE Conference on Computer Vision and Pattern Recognition (CVPR)*, June 2018.
- Jiasen Lu, Caiming Xiong, Devi Parikh, and Richard Socher. Knowing when to look: Adaptive attention via a visual sentinel for image captioning. In *The IEEE Conference on Computer Vision and Pattern Recognition (CVPR)*, July 2017.
- Xiankai Lu, Wenguan Wang, Chao Ma, Jianbing Shen, Ling Shao, and Fatih Porikli. See more, know more: Unsupervised video object segmentation with co-attention siamese networks. In *The IEEE Conference on Computer Vision and Pattern Recognition (CVPR)*, June 2019.
- Yao Lu, Xue Bai, Linda Shapiro, and Jue Wang. Coherent parametric contours for interactive video object segmentation. In *The IEEE Conference on Computer Vision and Pattern Recognition (CVPR)*, June 2016.
- Fujun Luan, Sylvain Paris, Eli Shechtman, and Kavita Bala. Deep photo style transfer. In *The IEEE Conference on Computer Vision and Pattern Recognition (CVPR)*, July 2017.
- Vincent Lui, Jonathon Geeves, Winston Yui, and Tom Drummond. Efficient subpixel refinement with symbolic linear predictors. In *The IEEE Conference on Computer Vision and Pattern Recognition (CVPR)*, June 2018.
- Alan Lukezic, Tomas Vojir, Luka Cehovin Zajc, Jiri Matas, and Matej Kristan. Discriminative correlation filter with channel and spatial reliability. In *The IEEE Conference on Computer Vision and Pattern Recognition (CVPR)*, July 2017.
- Guibo Luo, Yuesheng Zhu, Zhaotian Li, and Liming Zhang. A hole filling approach based on background reconstruction for view synthesis in 3d video. In *The IEEE Conference on Computer Vision and Pattern Recognition (CVPR)*, June 2016.
- Yawei Luo, Liang Zheng, Tao Guan, Junqing Yu, and Yi Yang. Taking a closer look at domain shift: Category-level adversaries for semantics consistent domain adaptation. In *The IEEE Conference on Computer Vision and Pattern Recognition (CVPR)*, June 2019.
- Yue Luo, Jimmy Ren, Mude Lin, Jiahao Pang, Wenxiu Sun, Hongsheng Li, and Liang Lin. Single view stereo matching. In *The IEEE Conference on Computer Vision and Pattern Recognition (CVPR)*, June 2018.
- Zelun Luo, Boya Peng, De-An Huang, Alexandre Alahi, and Li Fei-Fei. Unsupervised learning of long-term motion dynamics for videos. In *The IEEE Conference on Computer Vision and Pattern Recognition (CVPR)*, July 2017.
- Diogo C. Luvizon, David Picard, and Hedi Tabia. 2d/3d pose estimation and action recognition using multitask deep learning. In *The IEEE Conference on Computer Vision and Pattern Recognition (CVPR)*, June 2018.
- Jiangjing Lv, Xiaohu Shao, Junliang Xing, Cheng Cheng, and Xi Zhou. A deep regression architecture with two-stage re-initialization for high performance facial landmark detection. In *The IEEE Conference on Computer Vision and Pattern Recognition (CVPR)*, July 2017.
- Jianming Lv, Weihang Chen, Qing Li, and Can Yang. Unsupervised cross-dataset person re-identification by transfer learning of spatial-temporal patterns. In *The IEEE Conference on Computer Vision and Pattern Recognition (CVPR)*, June 2018.
- Zhaoyang Lv, Frank Dellaert, James M. Rehg, and Andreas Geiger. Taking a deeper look at the inverse compositional algorithm. In *The IEEE Conference on Computer Vision and Pattern Recognition (CVPR)*, June 2019.
- Pengyuan Lyu, Cong Yao, Wenhao Wu, Shuicheng Yan, and Xiang Bai. Multi-oriented scene text detection via corner localization and region segmentation. In *The IEEE Conference on Computer Vision and Pattern Recognition (CVPR)*, June 2018.

- Kede Ma, Qingbo Wu, Zhou Wang, Zhengfang Duanmu, Hongwei Yong, Hongliang Li, and Lei Zhang. Group mad competition - a new methodology to compare objective image quality models. In *The IEEE Conference on Computer Vision and Pattern Recognition (CVPR)*, June 2016.
- Liqian Ma, Qianru Sun, Stamatios Georgoulis, Luc Van Gool, Bernt Schiele, and Mario Fritz. Disentangled person image generation. In *The IEEE Conference on Computer Vision and Pattern Recognition (CVPR)*, June 2018.
- Wei-Chiu Ma, De-An Huang, Namhoon Lee, and Kris M. Kitani. Forecasting interactive dynamics of pedestrians with fictitious play. In *The IEEE Conference on Computer Vision and Pattern Recognition (CVPR)*, July 2017.
- Wei-Chiu Ma, Shenlong Wang, Rui Hu, Yuwen Xiong, and Raquel Urtasun. Deep rigid instance scene flow. In *The IEEE Conference on Computer Vision and Pattern Recognition (CVPR)*, June 2019.
- Oisin Mac Aodha, Shihan Su, Yuxin Chen, Pietro Perona, and Yisong Yue. Teaching categories to human learners with visual explanations. In *The IEEE Conference on Computer Vision and Pattern Recognition (CVPR)*, June 2018.
- Dennis Madsen, Marcel Lüthi, Andreas Schneider, and Thomas Vetter. Probabilistic joint face-skull modelling for facial reconstruction. In *The IEEE Conference on Computer Vision and Pattern Recognition (CVPR)*, June 2018.
- Nicolas Maerki, Federico Perazzi, Oliver Wang, and Alexander Sorkine-Hornung. Bilateral space video segmentation. In *The IEEE Conference on Computer Vision and Pattern Recognition (CVPR)*, June 2016.
- Luca Magri and Andrea Fusiello. Multiple model fitting as a set coverage problem. In *The IEEE Conference on Computer Vision and Pattern Recognition (CVPR)*, June 2016.
- Luca Magri and Andrea Fusiello. Fitting multiple heterogeneous models by multi-class cascaded t-linkage. In *The IEEE Conference on Computer Vision and Pattern Recognition (CVPR)*, June 2019.
- Tegan Maharaj, Nicolas Ballas, Anna Rohrbach, Aaron Courville, and Christopher Pal. A dataset and exploration of models for understanding video data through fill-in-the-blank question-answering. In *The IEEE Conference on Computer Vision and Pattern Recognition (CVPR)*, July 2017.
- Behrooz Mahasseni and Sinisa Todorovic. Regularizing long short term memory with 3d human-skeleton sequences for action recognition. In *The IEEE Conference on Computer Vision and Pattern Recognition (CVPR)*, June 2016.
- Behrooz Mahasseni, Michael Lam, and Sinisa Todorovic. Unsupervised video summarization with adversarial lstm networks. In *The IEEE Conference on Computer Vision and Pattern Recognition (CVPR)*, July 2017.
- M. R. Mahesh Mohan and A. N. Rajagopalan. Divide and conquer for full-resolution light field deblurring. In *The IEEE Conference on Computer Vision and Pattern Recognition (CVPR)*, June 2018.
- Reza Mahjourian, Martin Wicke, and Anelia Angelova. Unsupervised learning of depth and ego-motion from monocular video using 3d geometric constraints. In *The IEEE Conference on Computer Vision and Pattern Recognition (CVPR)*, June 2018.
- Long Mai, Hailin Jin, and Feng Liu. Composition-preserving deep photo aesthetics assessment. In *The IEEE Conference on Computer Vision and Pattern Recognition (CVPR)*, June 2016.
- Long Mai, Hailin Jin, Zhe Lin, Chen Fang, Jonathan Brandt, and Feng Liu. Spatial-semantic image search by visual feature synthesis. In *The IEEE Conference on Computer Vision and Pattern Recognition (CVPR)*, July 2017.

- Michael Maire, Takuya Narihira, and Stella X. Yu. Affinity cnn: Learning pixel-centric pairwise relations for figure/ground embedding. In *The IEEE Conference on Computer Vision and Pattern Recognition (CVPR)*, June 2016.
- Soumajit Majumder and Angela Yao. Content-aware multi-level guidance for interactive instance segmentation. In *The IEEE Conference on Computer Vision and Pattern Recognition (CVPR)*, June 2019.
- Osama Makansi, Eddy Ilg, Ozgun Cicek, and Thomas Brox. Overcoming limitations of mixture density networks: A sampling and fitting framework for multimodal future prediction. In *The IEEE Conference on Computer Vision and Pattern Recognition (CVPR)*, June 2019.
- Yasushi Makihara, Atsuyuki Suzuki, Daigo Muramatsu, Xiang Li, and Yasushi Yagi. Joint intensity and spatial metric learning for robust gait recognition. In *The IEEE Conference on Computer Vision and Pattern Recognition (CVPR)*, July 2017.
- Andrii Maksai and Pascal Fua. Eliminating exposure bias and metric mismatch in multiple object tracking. In *The IEEE Conference on Computer Vision and Pattern Recognition (CVPR)*, June 2019.
- Andrii Maksai, Xinchao Wang, and Pascal Fua. What players do with the ball: A physically constrained interaction modeling. In *The IEEE Conference on Computer Vision and Pattern Recognition (CVPR)*, June 2016.
- Anton Mallasto and Aasa Feragen. Wrapped gaussian process regression on riemannian manifolds. In *The IEEE Conference on Computer Vision and Pattern Recognition (CVPR)*, June 2018.
- Arun Mallya and Svetlana Lazebnik. Packnet: Adding multiple tasks to a single network by iterative pruning. In *The IEEE Conference on Computer Vision and Pattern Recognition (CVPR)*, June 2018.
- Abed Malti and Cedric Herzet. Elastic shape-from-template with spatially sparse deforming forces. In *The IEEE Conference on Computer Vision and Pattern Recognition (CVPR)*, July 2017.
- Massimiliano Mancini, Lorenzo Porzi, Samuel Rota Bulò, Barbara Caputo, and Elisa Ricci. Boosting domain adaptation by discovering latent domains. In *The IEEE Conference on Computer Vision and Pattern Recognition (CVPR)*, June 2018.
- Massimiliano Mancini, Samuel Rota Bulò, Barbara Caputo, and Elisa Ricci. Adagraph: Unifying predictive and continuous domain adaptation through graphs. In *The IEEE Conference on Computer Vision and Pattern Recognition (CVPR)*, June 2019.
- Devraj Mandal, Kunal N. Chaudhury, and Soma Biswas. Generalized semantic preserving hashing for n-label cross-modal retrieval. In *The IEEE Conference on Computer Vision and Pattern Recognition (CVPR)*, July 2017.
- Devraj Mandal, Sanath Narayan, Sai Kumar Dwivedi, Vikram Gupta, Shuaib Ahmed, Fahad Shahbaz Khan, and Ling Shao. Out-of-distribution detection for generalized zero-shot action recognition. In *The IEEE Conference on Computer Vision and Pattern Recognition (CVPR)*, June 2019.
- Jacques Manderscheid, Amos Sironi, Nicolas Bourdis, Davide Migliore, and Vincent Lepetit. Speed invariant time surface for learning to detect corner points with event-based cameras. In *The IEEE Conference on Computer Vision and Pattern Recognition (CVPR)*, June 2019.
- Fabian Manhardt, Wadim Kehl, and Adrien Gaidon. Roi-10d: Monocular lifting of 2d detection to 6d pose and metric shape. In *The IEEE Conference on Computer Vision and Pattern Recognition (CVPR)*, June 2019.
- Fabio Maninchedda, Martin R. Oswald, and Marc Pollefeys. Fast 3d reconstruction of faces with glasses. In *The IEEE Conference on Computer Vision and Pattern Recognition (CVPR)*, July 2017.

- Kevis-Kokitsi Maninis, Sergi Caelles, Jordi Pont-Tuset, and Luc Van Gool. Deep extreme cut: From extreme points to object segmentation. In *The IEEE Conference on Computer Vision and Pattern Recognition (CVPR)*, June 2018.
- Kevis-Kokitsi Maninis, Ilija Radosavovic, and Iasonas Kokkinos. Attentive single-tasking of multiple tasks. In *The IEEE Conference on Computer Vision and Pattern Recognition (CVPR)*, June 2019.
- Varun Manjunatha, Nirat Saini, and Larry S. Davis. Explicit bias discovery in visual question answering models. In *The IEEE Conference on Computer Vision and Pattern Recognition (CVPR)*, June 2019.
- Jiayuan Mao, Tete Xiao, Yuning Jiang, and Zhimin Cao. What can help pedestrian detection? In *The IEEE Conference on Computer Vision and Pattern Recognition (CVPR)*, July 2017.
- Junhua Mao, Jonathan Huang, Alexander Toshev, Oana Camburu, Alan L. Yuille, and Kevin Murphy. Generation and comprehension of unambiguous object descriptions. In *The IEEE Conference on Computer Vision and Pattern Recognition (CVPR)*, June 2016.
- Qi Mao, Hsin-Ying Lee, Hung-Yu Tseng, Siwei Ma, and Ming-Hsuan Yang. Mode seeking generative adversarial networks for diverse image synthesis. In *The IEEE Conference on Computer Vision and Pattern Recognition (CVPR)*, June 2019.
- Ana I. Maqueda, Antonio Loquercio, Guillermo Gallego, Narciso García, and Davide Scaramuzza. Event-based vision meets deep learning on steering prediction for self-driving cars. In *The IEEE Conference on Computer Vision and Pattern Recognition (CVPR)*, June 2018.
- Diego Marcos, Raffay Hamid, and Devis Tuia. Geospatial correspondences for multimodal registration. In *The IEEE Conference on Computer Vision and Pattern Recognition (CVPR)*, June 2016.
- Diego Marcos, Devis Tuia, Benjamin Kellenberger, Lisa Zhang, Min Bai, Renjie Liao, and Raquel Urtasun. Learning deep structured active contours end-to-end. In *The IEEE Conference on Computer Vision and Pattern Recognition (CVPR)*, June 2018.
- Dmitrii Marin, Meng Tang, Ismail Ben Ayed, and Yuri Boykov. Beyond gradient descent for regularized segmentation losses. In *The IEEE Conference on Computer Vision and Pattern Recognition (CVPR)*, June 2019.
- Manuel J. Marin-Jimenez, Vicky Kalogeiton, Pablo Medina-Suarez, and Andrew Zisserman. Laeonet: Revisiting people looking at each other in videos. In *The IEEE Conference on Computer Vision and Pattern Recognition (CVPR)*, June 2019.
- Kenneth Marino, Ruslan Salakhutdinov, and Abhinav Gupta. The more you know: Using knowledge graphs for image classification. In *The IEEE Conference on Computer Vision and Pattern Recognition (CVPR)*, July 2017.
- Kenneth Marino, Mohammad Rastegari, Ali Farhadi, and Roozbeh Mottaghi. Ok-vqa: A visual question answering benchmark requiring external knowledge. In *The IEEE Conference on Computer Vision and Pattern Recognition (CVPR)*, June 2019.
- Elisabeta Marinoiu, Mihai Zanfir, Vlad Olaru, and Cristian Sminchisescu. 3d human sensing, action and emotion recognition in robot assisted therapy of children with autism. In *The IEEE Conference on Computer Vision and Pattern Recognition (CVPR)*, June 2018.
- Mark Marsden, Kevin McGuinness, Suzanne Little, Ciara E. Keogh, and Noel E. O'Connor. People, penguins and petri dishes: Adapting object counting models to new visual domains and object types without forgetting. In *The IEEE Conference on Computer Vision and Pattern Recognition (CVPR)*, June 2018.
- Julietta Martinez, Michael J. Black, and Javier Romero. On human motion prediction using recurrent neural networks. In *The IEEE Conference on Computer Vision and Pattern Recognition (CVPR)*, July 2017.

- David Mascharka, Philip Tran, Ryan Soklaski, and Arjun Majumdar. Transparency by design: Closing the gap between performance and interpretability in visual reasoning. In *The IEEE Conference on Computer Vision and Pattern Recognition (CVPR)*, June 2018.
- Iacopo Masi, Stephen Rawls, Gerard Medioni, and Prem Natarajan. Pose-aware face recognition in the wild. In *The IEEE Conference on Computer Vision and Pattern Recognition (CVPR)*, June 2016.
- Francisco Massa, Bryan C. Russell, and Mathieu Aubry. Deep exemplar 2d-3d detection by adapting from real to rendered views. In *The IEEE Conference on Computer Vision and Pattern Recognition (CVPR)*, June 2016.
- Daniela Massiceti, N. Siddharth, Puneet K. Dokania, and Philip H.S. Torr. Flipdial: A generative model for two-way visual dialogue. In *The IEEE Conference on Computer Vision and Pattern Recognition (CVPR)*, June 2018.
- Brian Matejek, Daniel Haehn, Haidong Zhu, Donglai Wei, Toufiq Parag, and Hanspeter Pfister. Biologically-constrained graphs for global connectomics reconstruction. In *The IEEE Conference on Computer Vision and Pattern Recognition (CVPR)*, June 2019.
- Stefan Mathe, Aleksis Pirinen, and Cristian Sminchisescu. Reinforcement learning for visual object detection. In *The IEEE Conference on Computer Vision and Pattern Recognition (CVPR)*, June 2016.
- Alexander Mathews, Lexing Xie, and Xuming He. Semstyle: Learning to generate stylised image captions using unaligned text. In *The IEEE Conference on Computer Vision and Pattern Recognition (CVPR)*, June 2018.
- Tetsu Matsukawa, Takahiro Okabe, Einoshin Suzuki, and Yoichi Sato. Hierarchical gaussian descriptor for person re-identification. In *The IEEE Conference on Computer Vision and Pattern Recognition (CVPR)*, June 2016.
- Gellert Mattyus, Shenlong Wang, Sanja Fidler, and Raquel Urtasun. Hd maps: Fine-grained road segmentation by parsing ground and aerial images. In *The IEEE Conference on Computer Vision and Pattern Recognition (CVPR)*, June 2016.
- Nikolaus Mayer, Eddy Ilg, Philip Hausser, Philipp Fischer, Daniel Cremers, Alexey Dosovitskiy, and Thomas Brox. A large dataset to train convolutional networks for disparity, optical flow, and scene flow estimation. In *The IEEE Conference on Computer Vision and Pattern Recognition (CVPR)*, June 2016.
- Niall McLaughlin, Jesus Martinez del Rincon, and Paul Miller. Recurrent convolutional network for video-based person re-identification. In *The IEEE Conference on Computer Vision and Pattern Recognition (CVPR)*, June 2016.
- Éloi Mehr, André Lieutier, Fernando Sanchez Bermudez, Vincent Guitteny, Nicolas Thome, and Matthieu Cord. Manifold learning in quotient spaces. In *The IEEE Conference on Computer Vision and Pattern Recognition (CVPR)*, June 2018.
- Nazanin Mehrasa, Akash Abdu Jyothi, Thibaut Durand, Jiawei He, Leonid Sigal, and Greg Mori. A variational auto-encoder model for stochastic point processes. In *The IEEE Conference on Computer Vision and Pattern Recognition (CVPR)*, June 2019.
- Dushyant Mehta, Kwang In Kim, and Christian Theobalt. On implicit filter level sparsity in convolutional neural networks. In *The IEEE Conference on Computer Vision and Pattern Recognition (CVPR)*, June 2019.
- Yaron Meirovitch, Lu Mi, Hayk Saribekyan, Alexander Matveev, David Rolnick, and Nir Shavit. Cross-classification clustering: An efficient multi-object tracking technique for 3-d instance segmentation in connectomics. In *The IEEE Conference on Computer Vision and Pattern Recognition (CVPR)*, June 2019.

- Youssef A. Mejjati, Darren Cosker, and Kwang In Kim. Multi-task learning by maximizing statistical dependence. In *The IEEE Conference on Computer Vision and Pattern Recognition (CVPR)*, June 2018.
- Abhimitra Meka, Maxim Maximov, Michael Zollhöfer, Avishek Chatterjee, Hans-Peter Seidel, Christian Richardt, and Christian Theobalt. Lime: Live intrinsic material estimation. In *The IEEE Conference on Computer Vision and Pattern Recognition (CVPR)*, June 2018.
- Simone Melzi, Riccardo Spezialetti, Federico Tombari, Michael M. Bronstein, Luigi Di Stefano, and Emanuele Rodola. Gframes: Gradient-based local reference frame for 3d shape matching. In *The IEEE Conference on Computer Vision and Pattern Recognition (CVPR)*, June 2019.
- Yifang Men, Zhouhui Lian, Yingmin Tang, and Jianguo Xiao. A common framework for interactive texture transfer. In *The IEEE Conference on Computer Vision and Pattern Recognition (CVPR)*, June 2018.
- Yifang Men, Zhouhui Lian, Yingmin Tang, and Jianguo Xiao. Dyntypo: Example-based dynamic text effects transfer. In *The IEEE Conference on Computer Vision and Pattern Recognition (CVPR)*, June 2019.
- Jingjing Meng, Hongxing Wang, Junsong Yuan, and Yap-Peng Tan. From keyframes to key objects: Video summarization by representative object proposal selection. In *The IEEE Conference on Computer Vision and Pattern Recognition (CVPR)*, June 2016.
- Jingke Meng, Sheng Wu, and Wei-Shi Zheng. Weakly supervised person re-identification. In *The IEEE Conference on Computer Vision and Pattern Recognition (CVPR)*, June 2019.
- Fabian Mentzer, Eirikur Agustsson, Michael Tschannen, Radu Timofte, and Luc Van Gool. Conditional probability models for deep image compression. In *The IEEE Conference on Computer Vision and Pattern Recognition (CVPR)*, June 2018.
- Fabian Mentzer, Eirikur Agustsson, Michael Tschannen, Radu Timofte, and Luc Van Gool. Practical full resolution learned lossless image compression. In *The IEEE Conference on Computer Vision and Pattern Recognition (CVPR)*, June 2019.
- Daniel Merget, Matthias Rock, and Gerhard Rigoll. Robust facial landmark detection via a fully-convolutional local-global context network. In *The IEEE Conference on Computer Vision and Pattern Recognition (CVPR)*, June 2018.
- Lars Mescheder, Michael Oechsle, Michael Niemeyer, Sebastian Nowozin, and Andreas Geiger. Occupancy networks: Learning 3d reconstruction in function space. In *The IEEE Conference on Computer Vision and Pattern Recognition (CVPR)*, June 2019.
- Kourosh Meshgi, Shigeyuki Oba, and Shin Ishii. Efficient diverse ensemble for discriminative co-tracking. In *The IEEE Conference on Computer Vision and Pattern Recognition (CVPR)*, June 2018.
- Moustafa Meshry, Dan B. Goldman, Sameh Khamis, Hugues Hoppe, Rohit Pandey, Noah Snavely, and Ricardo Martin-Brualla. Neural re-rendering in the wild. In *The IEEE Conference on Computer Vision and Pattern Recognition (CVPR)*, June 2019.
- Gregory P. Meyer, Ankit Laddha, Eric Kee, Carlos Vallespi-Gonzalez, and Carl K. Wellington. Lasernet: An efficient probabilistic 3d object detector for autonomous driving. In *The IEEE Conference on Computer Vision and Pattern Recognition (CVPR)*, June 2019.
- Simone Meyer, Abdelaziz Djelouah, Brian McWilliams, Alexander Sorkine-Hornung, Markus Gross, and Christopher Schroers. Phasenet for video frame interpolation. In *The IEEE Conference on Computer Vision and Pattern Recognition (CVPR)*, June 2018.
- Jian-Xun Mi, Qiankun Fu, and Weisheng Li. Adaptive class preserving representation for image classification. In *The IEEE Conference on Computer Vision and Pattern Recognition (CVPR)*, July 2017.

- Caijing Miao, Lingxi Xie, Fang Wan, Chi Su, Hongye Liu, Jianbin Jiao, and Qixiang Ye. Sixray: A large-scale security inspection x-ray benchmark for prohibited item discovery in overlapping images. In *The IEEE Conference on Computer Vision and Pattern Recognition (CVPR)*, June 2019.
- Xin Miao, Xiantong Zhen, Xianglong Liu, Cheng Deng, Vassilis Athitsos, and Heng Huang. Direct shape regression networks for end-to-end face alignment. In *The IEEE Conference on Computer Vision and Pattern Recognition (CVPR)*, June 2018.
- Frank Michel, Alexander Kirillov, Eric Brachmann, Alexander Krull, Stefan Gumhold, Bogdan Savchynskyy, and Carsten Rother. Global hypothesis generation for 6d object pose estimation. In *The IEEE Conference on Computer Vision and Pattern Recognition (CVPR)*, July 2017.
- Keisuke Midorikawa, Toshihiko Yamasaki, and Kiyoharu Aizawa. Uncalibrated photometric stereo by stepwise optimization using principal components of isotropic brdfs. In *The IEEE Conference on Computer Vision and Pattern Recognition (CVPR)*, June 2016.
- Ondrej Miksik, Juan-Manuel Perez-Rua, Philip H. S. Torr, and Patrick Perez. Roam: A rich object appearance model with application to rotoscoping. In *The IEEE Conference on Computer Vision and Pattern Recognition (CVPR)*, July 2017.
- Ben Mildenhall, Jonathan T. Barron, Jiawen Chen, Dillon Sharlet, Ren Ng, and Robert Carroll. Burst denoising with kernel prediction networks. In *The IEEE Conference on Computer Vision and Pattern Recognition (CVPR)*, June 2018.
- Xiang Ming, Fangyun Wei, Ting Zhang, Dong Chen, and Fang Wen. Group sampling for scale invariant face detection. In *The IEEE Conference on Computer Vision and Pattern Recognition (CVPR)*, June 2019.
- Breton Minnehan and Andreas Savakis. Cascaded projection: End-to-end network compression and acceleration. In *The IEEE Conference on Computer Vision and Pattern Recognition (CVPR)*, June 2019.
- Pedro Miraldo, Francisco Eiras, and Srikumar Ramalingam. Analytical modeling of vanishing points and curves in catadioptric cameras. In *The IEEE Conference on Computer Vision and Pattern Recognition (CVPR)*, June 2018.
- Pedro Miraldo, Surojit Saha, and Srikumar Ramalingam. Minimal solvers for mini-loop closures in 3d multi-scan alignment. In *The IEEE Conference on Computer Vision and Pattern Recognition (CVPR)*, June 2019.
- Parsa Mirdehghan, Wenzheng Chen, and Kiriakos N. Kutulakos. Optimal structured light à la carte. In *The IEEE Conference on Computer Vision and Pattern Recognition (CVPR)*, June 2018.
- Ishan Misra, C. Lawrence Zitnick, Margaret Mitchell, and Ross Girshick. Seeing through the human reporting bias: Visual classifiers from noisy human-centric labels. In *The IEEE Conference on Computer Vision and Pattern Recognition (CVPR)*, June 2016.
- Ishan Misra, Abhinav Gupta, and Martial Hebert. From red wine to red tomato: Composition with context. In *The IEEE Conference on Computer Vision and Pattern Recognition (CVPR)*, July 2017.
- Ishan Misra, Ross Girshick, Rob Fergus, Martial Hebert, Abhinav Gupta, and Laurens van der Maaten. Learning by asking questions. In *The IEEE Conference on Computer Vision and Pattern Recognition (CVPR)*, June 2018.
- Niluthpol Chowdhury Mithun, Sujoy Paul, and Amit K. Roy-Chowdhury. Weakly supervised video moment retrieval from text queries. In *The IEEE Conference on Computer Vision and Pattern Recognition (CVPR)*, June 2019.
- Kaichun Mo, Shilin Zhu, Angel X. Chang, Li Yi, Subarna Tripathi, Leonidas J. Guibas, and Hao Su. Partnet: A large-scale benchmark for fine-grained and hierarchical part-level 3d object understanding. In *The IEEE Conference on Computer Vision and Pattern Recognition (CVPR)*, June 2019.

- Zhipeng Mo, Boxin Shi, Sai-Kit Yeung, and Yasuyuki Matsushita. Radiometric calibration for internet photo collections. In *The IEEE Conference on Computer Vision and Pattern Recognition (CVPR)*, July 2017.
- Zhipeng Mo, Boxin Shi, Feng Lu, Sai-Kit Yeung, and Yasuyuki Matsushita. Uncalibrated photometric stereo under natural illumination. In *The IEEE Conference on Computer Vision and Pattern Recognition (CVPR)*, June 2018.
- Apostolos Modas, Seyed-Mohsen Moosavi-Dezfooli, and Pascal Frossard. Sparsefool: A few pixels make a big difference. In *The IEEE Conference on Computer Vision and Pattern Recognition (CVPR)*, June 2019.
- Nima Mohajerin and Mohsen Rohani. Multi-step prediction of occupancy grid maps with recurrent neural networks. In *The IEEE Conference on Computer Vision and Pattern Recognition (CVPR)*, June 2019.
- Pritish Mohapatra, Michal Rolínek, C.V. Jawahar, Vladimir Kolmogorov, and M. Pawan Kumar. Efficient optimization for rank-based loss functions. In *The IEEE Conference on Computer Vision and Pattern Recognition (CVPR)*, June 2018.
- Pavlo Molchanov, Xiaodong Yang, Shalini Gupta, Kihwan Kim, Stephen Tyree, and Jan Kautz. Online detection and classification of dynamic hand gestures with recurrent 3d convolutional neural network. In *The IEEE Conference on Computer Vision and Pattern Recognition (CVPR)*, June 2016.
- Pavlo Molchanov, Arun Mallya, Stephen Tyree, Iuri Frosio, and Jan Kautz. Importance estimation for neural network pruning. In *The IEEE Conference on Computer Vision and Pattern Recognition (CVPR)*, June 2019.
- Thomas Mollenhoff and Daniel Cremers. Lifting vectorial variational problems: A natural formulation based on geometric measure theory and discrete exterior calculus. In *The IEEE Conference on Computer Vision and Pattern Recognition (CVPR)*, June 2019.
- Thomas Mollenhoff, Emanuel Laude, Michael Moeller, Jan Lellmann, and Daniel Cremers. Sublabel-accurate relaxation of nonconvex energies. In *The IEEE Conference on Computer Vision and Pattern Recognition (CVPR)*, June 2016.
- Davide Moltisanti, Sanja Fidler, and Dima Damen. Action recognition from single timestamp supervision in untrimmed videos. In *The IEEE Conference on Computer Vision and Pattern Recognition (CVPR)*, June 2019.
- Federico Monti, Davide Boscaini, Jonathan Masci, Emanuele Rodola, Jan Svoboda, and Michael M. Bronstein. Geometric deep learning on graphs and manifolds using mixture model cnns. In *The IEEE Conference on Computer Vision and Pattern Recognition (CVPR)*, July 2017.
- Kwang Moo Yi, Yannick Verdie, Pascal Fua, and Vincent Lepetit. Learning to assign orientations to feature points. In *The IEEE Conference on Computer Vision and Pattern Recognition (CVPR)*, June 2016.
- Gyeongsik Moon, Ju Yong Chang, and Kyoung Mu Lee. V2v-poseNet: Voxel-to-voxel prediction network for accurate 3d hand and human pose estimation from a single depth map. In *The IEEE Conference on Computer Vision and Pattern Recognition (CVPR)*, June 2018.
- Gyeongsik Moon, Ju Yong Chang, and Kyoung Mu Lee. Posefix: Model-agnostic general human pose refinement network. In *The IEEE Conference on Computer Vision and Pattern Recognition (CVPR)*, June 2019.
- Seyed-Mohsen Moosavi-Dezfooli, Alhussein Fawzi, and Pascal Frossard. Deepfool: A simple and accurate method to fool deep neural networks. In *The IEEE Conference on Computer Vision and Pattern Recognition (CVPR)*, June 2016.
- Seyed-Mohsen Moosavi-Dezfooli, Alhussein Fawzi, Omar Fawzi, and Pascal Frossard. Universal adversarial perturbations. In *The IEEE Conference on Computer Vision and Pattern Recognition (CVPR)*, July 2017.

- Seyed-Mohsen Moosavi-Dezfooli, Alhussein Fawzi, Jonathan Uesato, and Pascal Frossard. Robustness via curvature regularization, and vice versa. In *The IEEE Conference on Computer Vision and Pattern Recognition (CVPR)*, June 2019.
- Romero Morais, Vuong Le, Truyen Tran, Budhaditya Saha, Moussa Mansour, and Svetha Venkatesh. Learning regularity in skeleton trajectories for anomaly detection in videos. In *The IEEE Conference on Computer Vision and Pattern Recognition (CVPR)*, June 2019.
- Francesc Moreno-Noguer. 3d human pose estimation from a single image via distance matrix regression. In *The IEEE Conference on Computer Vision and Pattern Recognition (CVPR)*, July 2017.
- Pedro Morgado and Nuno Vasconcelos. Semantically consistent regularization for zero-shot recognition. In *The IEEE Conference on Computer Vision and Pattern Recognition (CVPR)*, July 2017.
- Pedro Morgado and Nuno Vasconcelos. Netailor: Tuning the architecture, not just the weights. In *The IEEE Conference on Computer Vision and Pattern Recognition (CVPR)*, June 2019.
- Dustin Morley and Hassan Foroosh. Improving ransac-based segmentation through cnn encapsulation. In *The IEEE Conference on Computer Vision and Pattern Recognition (CVPR)*, July 2017.
- Seyed Morteza Safdarnejad and Xiaoming Liu. Spatio-temporal alignment of non-overlapping sequences from independently panning cameras. In *The IEEE Conference on Computer Vision and Pattern Recognition (CVPR)*, July 2017.
- Agata Mosinska, Pablo Márquez-Neila, Mateusz Koziński, and Pascal Fua. Beyond the pixel-wise loss for topology-aware delineation. In *The IEEE Conference on Computer Vision and Pattern Recognition (CVPR)*, June 2018.
- Agata Mosinska-Domanska, Raphael Sznitman, Przemyslaw Glowacki, and Pascal Fua. Active learning for delineation of curvilinear structures. In *The IEEE Conference on Computer Vision and Pattern Recognition (CVPR)*, June 2016.
- Mohammadreza Mostajabi, Michael Maire, and Gregory Shakhnarovich. Regularizing deep networks by modeling and predicting label structure. In *The IEEE Conference on Computer Vision and Pattern Recognition (CVPR)*, June 2018.
- Christian Mostegel, Markus Rumpel, Friedrich Fraundorfer, and Horst Bischof. Using self-contradiction to learn confidence measures in stereo vision. In *The IEEE Conference on Computer Vision and Pattern Recognition (CVPR)*, June 2016.
- Christian Mostegel, Rudolf Prettenthaler, Friedrich Fraundorfer, and Horst Bischof. Scalable surface reconstruction from point clouds with extreme scale and density diversity. In *The IEEE Conference on Computer Vision and Pattern Recognition (CVPR)*, July 2017.
- Saeid Motiian, Marco Piccirilli, Donald A. Adjeroh, and Gianfranco Doretto. Information bottleneck learning using privileged information for visual recognition. In *The IEEE Conference on Computer Vision and Pattern Recognition (CVPR)*, June 2016.
- Roosbeh Mottaghi, Hannaneh Hajishirzi, and Ali Farhadi. A task-oriented approach for cost-sensitive recognition. In *The IEEE Conference on Computer Vision and Pattern Recognition (CVPR)*, June 2016.
- Lichao Mou, Yuansheng Hua, and Xiao Xiang Zhu. A relation-augmented fully convolutional network for semantic segmentation in aerial scenes. In *The IEEE Conference on Computer Vision and Pattern Recognition (CVPR)*, June 2019.
- Arsalan Mousavian, Dragomir Anguelov, John Flynn, and Jana Kosecka. 3d bounding box estimation using deep learning and geometry. In *The IEEE Conference on Computer Vision and Pattern Recognition (CVPR)*, July 2017.
- Guodong Mu, Di Huang, Guosheng Hu, Jia Sun, and Yunhong Wang. Led3d: A lightweight and efficient deep approach to recognizing low-quality 3d faces. In *The IEEE Conference on Computer Vision and Pattern Recognition (CVPR)*, June 2019.

- Franziska Mueller, Florian Bernard, Oleksandr Sotnychenko, Dushyant Mehta, Srinath Sridhar, Dan Casas, and Christian Theobalt. Gnerated hands for real-time 3d hand tracking from monocular rgb. In *The IEEE Conference on Computer Vision and Pattern Recognition (CVPR)*, June 2018.
- Matthias Mueller, Neil Smith, and Bernard Ghanem. Context-aware correlation filter tracking. In *The IEEE Conference on Computer Vision and Pattern Recognition (CVPR)*, July 2017.
- Lopamudra Mukherjee, Sathya N. Ravi, Jiming Peng, and Vikas Singh. A biresolution spectral framework for product quantization. In *The IEEE Conference on Computer Vision and Pattern Recognition (CVPR)*, June 2018.
- Arun Mukundan, Giorgos Toliass, and Ondrej Chum. Explicit spatial encoding for deep local descriptors. In *The IEEE Conference on Computer Vision and Pattern Recognition (CVPR)*, June 2019.
- Yusuke Mukuta and Tatsuya Harada. Kernel approximation via empirical orthogonal decomposition for unsupervised feature learning. In *The IEEE Conference on Computer Vision and Pattern Recognition (CVPR)*, June 2016.
- Jonghwan Mun, Linjie Yang, Zhou Ren, Ning Xu, and Bohyung Han. Streamlined dense video captioning. In *The IEEE Conference on Computer Vision and Pattern Recognition (CVPR)*, June 2019.
- Martin Mundt, Sagnik Majumder, Sreenivas Murali, Panagiotis Panetsos, and Visvanathan Ramesh. Meta-learning convolutional neural architectures for multi-target concrete defect classification with the concrete defect bridge image dataset. In *The IEEE Conference on Computer Vision and Pattern Recognition (CVPR)*, June 2019.
- Bharti Munjal, Sikandar Amin, Federico Tombari, and Fabio Galasso. Query-guided end-to-end person search. In *The IEEE Conference on Computer Vision and Pattern Recognition (CVPR)*, June 2019.
- Sanjeev Muralikrishnan, Vladimir G. Kim, and Siddhartha Chaudhuri. Tags2parts: Discovering semantic regions from shape tags. In *The IEEE Conference on Computer Vision and Pattern Recognition (CVPR)*, June 2018.
- Sanjeev Muralikrishnan, Vladimir G. Kim, Matthew Fisher, and Siddhartha Chaudhuri. Shape unicode: A unified shape representation. In *The IEEE Conference on Computer Vision and Pattern Recognition (CVPR)*, June 2019.
- Calvin Murdock and Fernando De la Torre. Additive component analysis. In *The IEEE Conference on Computer Vision and Pattern Recognition (CVPR)*, July 2017.
- Calvin Murdock, Zhen Li, Howard Zhou, and Tom Duerig. Blockout: Dynamic model selection for hierarchical deep networks. In *The IEEE Conference on Computer Vision and Pattern Recognition (CVPR)*, June 2016.
- Zak Murez, Soheil Kolouri, David Kriegman, Ravi Ramamoorthi, and Kyungnam Kim. Image to image translation for domain adaptation. In *The IEEE Conference on Computer Vision and Pattern Recognition (CVPR)*, June 2018.
- Nils Murrugarra-Llerena and Adriana Kovashka. Cross-modality personalization for retrieval. In *The IEEE Conference on Computer Vision and Pattern Recognition (CVPR)*, June 2019.
- Venkatesh N. Murthy, Vivek Singh, Terrence Chen, R. Manmatha, and Dorin Comaniciu. Deep decision network for multi-class image classification. In *The IEEE Conference on Computer Vision and Pattern Recognition (CVPR)*, June 2016.
- Armin Mustafa and Adrian Hilton. Semantically coherent co-segmentation and reconstruction of dynamic scenes. In *The IEEE Conference on Computer Vision and Pattern Recognition (CVPR)*, July 2017.

- Armin Mustafa, Hansung Kim, Jean-Yves Guillemaut, and Adrian Hilton. Temporally coherent 4d reconstruction of complex dynamic scenes. In *The IEEE Conference on Computer Vision and Pattern Recognition (CVPR)*, June 2016.
- Arsha Nagrani, Samuel Albanie, and Andrew Zisserman. Seeing voices and hearing faces: Cross-modal biometric matching. In *The IEEE Conference on Computer Vision and Pattern Recognition (CVPR)*, June 2018.
- Seungjun Nah, Tae Hyun Kim, and Kyoung Mu Lee. Deep multi-scale convolutional neural network for dynamic scene deblurring. In *The IEEE Conference on Computer Vision and Pattern Recognition (CVPR)*, July 2017.
- Seungjun Nah, Sanghyun Son, and Kyoung Mu Lee. Recurrent neural networks with intra-frame iterations for video deblurring. In *The IEEE Conference on Computer Vision and Pattern Recognition (CVPR)*, June 2019.
- Mohammad Najafi, Sarah Taghavi Namin, Mathieu Salzmann, and Lars Petersson. Sample and filter: Nonparametric scene parsing via efficient filtering. In *The IEEE Conference on Computer Vision and Pattern Recognition (CVPR)*, June 2016.
- Mahyar Najibi, Mohammad Rastegari, and Larry S. Davis. G-cnn: An iterative grid based object detector. In *The IEEE Conference on Computer Vision and Pattern Recognition (CVPR)*, June 2016.
- Mahyar Najibi, Bharat Singh, and Larry S. Davis. Fa-rpn: Floating region proposals for face detection. In *The IEEE Conference on Computer Vision and Pattern Recognition (CVPR)*, June 2019.
- Katsuyuki Nakamura, Serena Yeung, Alexandre Alahi, and Li Fei-Fei. Jointly learning energy expenditures and activities using egocentric multimodal signals. In *The IEEE Conference on Computer Vision and Pattern Recognition (CVPR)*, July 2017.
- Giljoo Nam, Chenglei Wu, Min H. Kim, and Yaser Sheikh. Strand-accurate multi-view hair capture. In *The IEEE Conference on Computer Vision and Pattern Recognition (CVPR)*, June 2019.
- Hyeonseob Nam, Jung-Woo Ha, and Jeonghee Kim. Dual attention networks for multimodal reasoning and matching. In *The IEEE Conference on Computer Vision and Pattern Recognition (CVPR)*, July 2017.
- Seonghyeon Nam, Youngbae Hwang, Yasuyuki Matsushita, and Seon Joo Kim. A holistic approach to cross-channel image noise modeling and its application to image denoising. In *The IEEE Conference on Computer Vision and Pattern Recognition (CVPR)*, June 2016.
- Pradyumna Narayana, Ross Beveridge, and Bruce A. Draper. Gesture recognition: Focus on the hands. In *The IEEE Conference on Computer Vision and Pattern Recognition (CVPR)*, June 2018.
- Behrooz Nasihatkon, Frida Fejne, and Fredrik Kahl. Globally optimal rigid intensity based registration: A fast fourier domain approach. In *The IEEE Conference on Computer Vision and Pattern Recognition (CVPR)*, June 2016.
- Jogendra Nath Kundu, Phani Krishna Uppala, Anuj Pahuja, and R. Venkatesh Babu. Adadepth: Unsupervised content congruent adaptation for depth estimation. In *The IEEE Conference on Computer Vision and Pattern Recognition (CVPR)*, June 2018.
- T. Nathan Mundhenk, Daniel Ho, and Barry Y. Chen. Improvements to context based self-supervised learning. In *The IEEE Conference on Computer Vision and Pattern Recognition (CVPR)*, June 2018.
- Fabrizio Natola, Valsamis Ntouskos, Fiora Pirri, and Marta Sanzari. Single image object modeling based on brdf and r-surfaces learning. In *The IEEE Conference on Computer Vision and Pattern Recognition (CVPR)*, June 2016.

- Ryota Natsume, Shunsuke Saito, Zeng Huang, Weikai Chen, Chongyang Ma, Hao Li, and Shigeo Morishima. Siclope: Silhouette-based clothed people. In *The IEEE Conference on Computer Vision and Pattern Recognition (CVPR)*, June 2019.
- Aaron Nech and Ira Kemelmacher-Shlizerman. Level playing field for million scale face recognition. In *The IEEE Conference on Computer Vision and Pattern Recognition (CVPR)*, July 2017.
- Vladimir Nekrasov, Hao Chen, Chunhua Shen, and Ian Reid. Fast neural architecture search of compact semantic segmentation models via auxiliary cells. In *The IEEE Conference on Computer Vision and Pattern Recognition (CVPR)*, June 2019.
- Thomas Nestmeyer and Peter V. Gehler. Reflectance adaptive filtering improves intrinsic image estimation. In *The IEEE Conference on Computer Vision and Pattern Recognition (CVPR)*, July 2017.
- Davy Neven, Bert De Brabandere, Marc Proesmans, and Luc Van Gool. Instance segmentation by jointly optimizing spatial embeddings and clustering bandwidth. In *The IEEE Conference on Computer Vision and Pattern Recognition (CVPR)*, June 2019.
- Natalia Neverova, James Thewlis, Riza Alp Guler, Iasonas Kokkinos, and Andrea Vedaldi. Slim densepose: Thrifty learning from sparse annotations and motion cues. In *The IEEE Conference on Computer Vision and Pattern Recognition (CVPR)*, June 2019.
- Anh Nguyen, Jeff Clune, Yoshua Bengio, Alexey Dosovitskiy, and Jason Yosinski. Plug play generative networks: Conditional iterative generation of images in latent space. In *The IEEE Conference on Computer Vision and Pattern Recognition (CVPR)*, July 2017.
- Duy-Kien Nguyen and Takayuki Okatani. Improved fusion of visual and language representations by dense symmetric co-attention for visual question answering. In *The IEEE Conference on Computer Vision and Pattern Recognition (CVPR)*, June 2018.
- Duy-Kien Nguyen and Takayuki Okatani. Multi-task learning of hierarchical vision-language representation. In *The IEEE Conference on Computer Vision and Pattern Recognition (CVPR)*, June 2019.
- Rang M. H. Nguyen and Michael S. Brown. Raw image reconstruction using a self-contained srgb-jpeg image with only 64 kb overhead. In *The IEEE Conference on Computer Vision and Pattern Recognition (CVPR)*, June 2016.
- Chi Nhan Duong, Khoa Luu, Kha Gia Quach, and Tien D. Bui. Longitudinal face modeling via temporal deep restricted boltzmann machines. In *The IEEE Conference on Computer Vision and Pattern Recognition (CVPR)*, June 2016.
- Bingbing Ni, Xiaokang Yang, and Shenghua Gao. Progressively parsing interactional objects for fine grained action detection. In *The IEEE Conference on Computer Vision and Pattern Recognition (CVPR)*, June 2016.
- Tianwei Ni, Lingxi Xie, Huangjie Zheng, Elliot K. Fishman, and Alan L. Yuille. Elastic boundary projection for 3d medical image segmentation. In *The IEEE Conference on Computer Vision and Pattern Recognition (CVPR)*, June 2019.
- Guang-Yu Nie, Ming-Ming Cheng, Yun Liu, Zhengfa Liang, Deng-Ping Fan, Yue Liu, and Yongtian Wang. Multi-level context ultra-aggregation for stereo matching. In *The IEEE Conference on Computer Vision and Pattern Recognition (CVPR)*, June 2019.
- Xuecheng Nie, Jiashi Feng, Yiming Zuo, and Shuicheng Yan. Human pose estimation with parsing induced learner. In *The IEEE Conference on Computer Vision and Pattern Recognition (CVPR)*, June 2018.
- Marc Niethammer, Roland Kwitt, and Francois-Xavier Vialard. Metric learning for image registration. In *The IEEE Conference on Computer Vision and Pattern Recognition (CVPR)*, June 2019.

- Yusuke Niitani, Takuya Akiba, Tommi Kerola, Toru Ogawa, Shotaro Sano, and Shuji Suzuki. Sampling techniques for large-scale object detection from sparsely annotated objects. In *The IEEE Conference on Computer Vision and Pattern Recognition (CVPR)*, June 2019.
- Simon Niklaus and Feng Liu. Context-aware synthesis for video frame interpolation. In *The IEEE Conference on Computer Vision and Pattern Recognition (CVPR)*, June 2018.
- Simon Niklaus, Long Mai, and Feng Liu. Video frame interpolation via adaptive convolution. In *The IEEE Conference on Computer Vision and Pattern Recognition (CVPR)*, July 2017.
- David Nilsson and Cristian Sminchisescu. Semantic video segmentation by gated recurrent flow propagation. In *The IEEE Conference on Computer Vision and Pattern Recognition (CVPR)*, June 2018.
- Jifeng Ning, Jimei Yang, Shaojie Jiang, Lei Zhang, and Ming-Hsuan Yang. Object tracking via dual linear structured svm and explicit feature map. In *The IEEE Conference on Computer Vision and Pattern Recognition (CVPR)*, June 2016.
- Chengjie Niu, Jun Li, and Kai Xu. Im2struct: Recovering 3d shape structure from a single rgb image. In *The IEEE Conference on Computer Vision and Pattern Recognition (CVPR)*, June 2018.
- Yulei Niu, Hanwang Zhang, Manli Zhang, Jianhong Zhang, Zhiwu Lu, and Ji-Rong Wen. Recursive visual attention in visual dialog. In *The IEEE Conference on Computer Vision and Pattern Recognition (CVPR)*, June 2019.
- Zhenxing Niu, Mo Zhou, Le Wang, Xinbo Gao, and Gang Hua. Ordinal regression with multiple output cnn for age estimation. In *The IEEE Conference on Computer Vision and Pattern Recognition (CVPR)*, June 2016.
- Hyeonwoo Noh, Paul Hongsuck Seo, and Bohyung Han. Image question answering using convolutional neural network with dynamic parameter prediction. In *The IEEE Conference on Computer Vision and Pattern Recognition (CVPR)*, June 2016.
- Hyeonwoo Noh, Taehoon Kim, Jonghwan Mun, and Bohyung Han. Transfer learning via unsupervised task discovery for visual question answering. In *The IEEE Conference on Computer Vision and Pattern Recognition (CVPR)*, June 2019.
- Junhyug Noh, Soochan Lee, Beomsu Kim, and Gunhee Kim. Improving occlusion and hard negative handling for single-stage pedestrian detectors. In *The IEEE Conference on Computer Vision and Pattern Recognition (CVPR)*, June 2018.
- Mehdi Noroozi, Ananth Vinjimoor, Paolo Favaro, and Hamed Pirsiavash. Boosting self-supervised learning via knowledge transfer. In *The IEEE Conference on Computer Vision and Pattern Recognition (CVPR)*, June 2018.
- Sotiris Nousias, Manolis Lourakis, and Christos Bergeles. Large-scale, metric structure from motion for unordered light fields. In *The IEEE Conference on Computer Vision and Pattern Recognition (CVPR)*, June 2019.
- David Novotny, Diane Larlus, and Andrea Vedaldi. AnchorNet: A weakly supervised network to learn geometry-sensitive features for semantic matching. In *The IEEE Conference on Computer Vision and Pattern Recognition (CVPR)*, July 2017.
- David Novotny, Samuel Albanie, Diane Larlus, and Andrea Vedaldi. Self-supervised learning of geometrically stable features through probabilistic introspection. In *The IEEE Conference on Computer Vision and Pattern Recognition (CVPR)*, June 2018.
- Markus Oberweger, Gernot Riegler, Paul Wohlhart, and Vincent Lepetit. Efficiently creating 3d training data for fine hand pose estimation. In *The IEEE Conference on Computer Vision and Pattern Recognition (CVPR)*, June 2016.
- Nati Ofir, Meirav Galun, Boaz Nadler, and Ronen Basri. Fast detection of curved edges at low snr. In *The IEEE Conference on Computer Vision and Pattern Recognition (CVPR)*, June 2016.

- Seoung Wug Oh, Joon-Young Lee, Ning Xu, and Seon Joo Kim. Fast user-guided video object segmentation by interaction-and-propagation networks. In *The IEEE Conference on Computer Vision and Pattern Recognition (CVPR)*, June 2019.
- Katsunori Ohnishi, Atsushi Kanehira, Asako Kanezaki, and Tatsuya Harada. Recognizing activities of daily living with a wrist-mounted camera. In *The IEEE Conference on Computer Vision and Pattern Recognition (CVPR)*, June 2016.
- Eng-Jon Ong and Mirosław Bober. Improved hamming distance search using variable length substrings. In *The IEEE Conference on Computer Vision and Pattern Recognition (CVPR)*, June 2016.
- Roy Or-El, Rom Hershkovitz, Aaron Wetzler, Guy Rosman, Alfred M. Bruckstein, and Ron Kimmel. Real-time depth refinement for specular objects. In *The IEEE Conference on Computer Vision and Pattern Recognition (CVPR)*, June 2016.
- Tribhuvanesh Orekondy, Mario Fritz, and Bernt Schiele. Connecting pixels to privacy and utility: Automatic redaction of private information in images. In *The IEEE Conference on Computer Vision and Pattern Recognition (CVPR)*, June 2018.
- Tribhuvanesh Orekondy, Bernt Schiele, and Mario Fritz. Knockoff nets: Stealing functionality of black-box models. In *The IEEE Conference on Computer Vision and Pattern Recognition (CVPR)*, June 2019.
- Marin Orsic, Ivan Kreso, Petra Bevandic, and Sinisa Segvic. In defense of pre-trained imagenet architectures for real-time semantic segmentation of road-driving images. In *The IEEE Conference on Computer Vision and Pattern Recognition (CVPR)*, June 2019.
- Kazuki Osawa, Yohei Tsuji, Yuichiro Ueno, Akira Naruse, Rio Yokota, and Satoshi Matsuoka. Large-scale distributed second-order optimization using kronecker-factored approximate curvature for deep convolutional neural networks. In *The IEEE Conference on Computer Vision and Pattern Recognition (CVPR)*, June 2019.
- Magnus Oskarsson, Kenneth Batstone, and Kalle Astrom. Trust no one: Low rank matrix factorization using hierarchical ransac. In *The IEEE Conference on Computer Vision and Pattern Recognition (CVPR)*, June 2016.
- Ali Osman Ulusoy, Michael J. Black, and Andreas Geiger. Patches, planes and probabilities: A non-local prior for volumetric 3d reconstruction. In *The IEEE Conference on Computer Vision and Pattern Recognition (CVPR)*, June 2016.
- Ali Osman Ulusoy, Michael J. Black, and Andreas Geiger. Semantic multi-view stereo: Jointly estimating objects and voxels. In *The IEEE Conference on Computer Vision and Pattern Recognition (CVPR)*, July 2017.
- Oleksiy Ostapenko, Mihai Puscas, Tassilo Klein, Patrick Jahnichen, and Moin Nabi. Learning to remember: A synaptic plasticity driven framework for continual learning. In *The IEEE Conference on Computer Vision and Pattern Recognition (CVPR)*, June 2019.
- Mayu Otani, Yuta Nakashima, Esa Rahtu, and Janne Heikkila. Rethinking the evaluation of video summaries. In *The IEEE Conference on Computer Vision and Pattern Recognition (CVPR)*, June 2019.
- Matthew O'Toole, Felix Heide, David B. Lindell, Kai Zang, Steven Diamond, and Gordon Wetzstein. Reconstructing transient images from single-photon sensors. In *The IEEE Conference on Computer Vision and Pattern Recognition (CVPR)*, July 2017.
- Tycho F.A. van der Ouderaa and Daniel E. Worrall. Reversible gans for memory-efficient image-to-image translation. In *The IEEE Conference on Computer Vision and Pattern Recognition (CVPR)*, June 2019.
- Wanli Ouyang, Xiaogang Wang, Cong Zhang, and Xiaokang Yang. Factors in finetuning deep model for object detection with long-tail distribution. In *The IEEE Conference on Computer Vision and Pattern Recognition (CVPR)*, June 2016.

- Andrew Owens, Phillip Isola, Josh McDermott, Antonio Torralba, Edward H. Adelson, and William T. Freeman. Visually indicated sounds. In *The IEEE Conference on Computer Vision and Pattern Recognition (CVPR)*, June 2016.
- Edouard Oyallon. Building a regular decision boundary with deep networks. In *The IEEE Conference on Computer Vision and Pattern Recognition (CVPR)*, July 2017.
- Poojan Oza and Vishal M. Patel. C2ae: Class conditioned auto-encoder for open-set recognition. In *The IEEE Conference on Computer Vision and Pattern Recognition (CVPR)*, June 2019.
- Arghya Pal and Vineeth N. Balasubramanian. Adversarial data programming: Using gans to relax the bottleneck of curated labeled data. In *The IEEE Conference on Computer Vision and Pattern Recognition (CVPR)*, June 2018.
- Arghya Pal and Vineeth N Balasubramanian. Zero-shot task transfer. In *The IEEE Conference on Computer Vision and Pattern Recognition (CVPR)*, June 2019.
- Dipan K. Pal, Felix Juefei-Xu, and Marios Savvides. Discriminative invariant kernel features: A bells-and-whistles-free approach to unsupervised face recognition and pose estimation. In *The IEEE Conference on Computer Vision and Pattern Recognition (CVPR)*, June 2016.
- Sebastian Palacio, Joachim Folz, Jörn Hees, Federico Raue, Damian Borth, and Andreas Dengel. What do deep networks like to see? In *The IEEE Conference on Computer Vision and Pattern Recognition (CVPR)*, June 2018.
- Tobias Palmer, Kalle Astrom, and Jan-Michael Frahm. The misty three point algorithm for relative pose. In *The IEEE Conference on Computer Vision and Pattern Recognition (CVPR)*, July 2017.
- Bowen Pan, Wuwei Lin, Xiaolin Fang, Chaoqin Huang, Bolei Zhou, and Cewu Lu. Recurrent residual module for fast inference in videos. In *The IEEE Conference on Computer Vision and Pattern Recognition (CVPR)*, June 2018.
- Jinshan Pan, Zhe Hu, Zhixun Su, Hsin-Ying Lee, and Ming-Hsuan Yang. Soft-segmentation guided object motion deblurring. In *The IEEE Conference on Computer Vision and Pattern Recognition (CVPR)*, June 2016.
- Jinshan Pan, Jiangxin Dong, Jimmy S. Ren, Liang Lin, Jinhui Tang, and Ming-Hsuan Yang. Spatially variant linear representation models for joint filtering. In *The IEEE Conference on Computer Vision and Pattern Recognition (CVPR)*, June 2019.
- Liyuan Pan, Yuchao Dai, Miaomiao Liu, and Fatih Porikli. Simultaneous stereo video deblurring and scene flow estimation. In *The IEEE Conference on Computer Vision and Pattern Recognition (CVPR)*, July 2017.
- Rameswar Panda, Amran Bhuiyan, Vittorio Murino, and Amit K. Roy-Chowdhury. Unsupervised adaptive re-identification in open world dynamic camera networks. In *The IEEE Conference on Computer Vision and Pattern Recognition (CVPR)*, July 2017.
- Rohit Pandey, Anastasia Tkach, Shuoran Yang, Pavel Pidlypenskyi, Jonathan Taylor, Ricardo Martin-Brualla, Andrea Tagliasacchi, George Papandreou, Philip Davidson, Cem Keskin, Shahram Izadi, and Sean Fanello. Volumetric capture of humans with a single rgbd camera via semi-parametric learning. In *The IEEE Conference on Computer Vision and Pattern Recognition (CVPR)*, June 2019.
- Bo Pang, Kaiwen Zha, Hanwen Cao, Chen Shi, and Cewu Lu. Deep rnn framework for visual sequential applications. In *The IEEE Conference on Computer Vision and Pattern Recognition (CVPR)*, June 2019.
- Jiahao Pang, Wenxiu Sun, Chengxi Yang, Jimmy Ren, Ruichao Xiao, Jin Zeng, and Liang Lin. Zoom and learn: Generalizing deep stereo matching to novel domains. In *The IEEE Conference on Computer Vision and Pattern Recognition (CVPR)*, June 2018.
- Pankaj Pansari and M. Pawan Kumar. Truncated max-of-convex models. In *The IEEE Conference on Computer Vision and Pattern Recognition (CVPR)*, July 2017.

- Dim P. Papadopoulos, Jasper R. R. Uijlings, Frank Keller, and Vittorio Ferrari. We don't need no bounding-boxes: Training object class detectors using only human verification. In *The IEEE Conference on Computer Vision and Pattern Recognition (CVPR)*, June 2016.
- Dim P. Papadopoulos, Jasper R. R. Uijlings, Frank Keller, and Vittorio Ferrari. Training object class detectors with click supervision. In *The IEEE Conference on Computer Vision and Pattern Recognition (CVPR)*, July 2017.
- Dim P. Papadopoulos, Youssef Tamaazousti, Ferda Ofli, Ingmar Weber, and Antonio Torralba. How to make a pizza: Learning a compositional layer-based gan model. In *The IEEE Conference on Computer Vision and Pattern Recognition (CVPR)*, June 2019.
- George Papandreou, Tyler Zhu, Nori Kanazawa, Alexander Toshev, Jonathan Tompson, Chris Bregler, and Kevin Murphy. Towards accurate multi-person pose estimation in the wild. In *The IEEE Conference on Computer Vision and Pattern Recognition (CVPR)*, July 2017.
- Konstantinos Papoutsakis, Costas Panagiotakis, and Antonis A. Argyros. Temporal action co-segmentation in 3d motion capture data and videos. In *The IEEE Conference on Computer Vision and Pattern Recognition (CVPR)*, July 2017.
- Shaifali Parashar, Daniel Pizarro, and Adrien Bartoli. Isometric non-rigid shape-from-motion in linear time. In *The IEEE Conference on Computer Vision and Pattern Recognition (CVPR)*, June 2016.
- Jaesik Park, Yu-Wing Tai, Sudipta N. Sinha, and In So Kweon. Efficient and robust color consistency for community photo collections. In *The IEEE Conference on Computer Vision and Pattern Recognition (CVPR)*, June 2016.
- Jeong Joon Park, Peter Florence, Julian Straub, Richard Newcombe, and Steven Lovegrove. DeepSDF: Learning continuous signed distance functions for shape representation. In *The IEEE Conference on Computer Vision and Pattern Recognition (CVPR)*, June 2019.
- Jongchan Park, Joon-Young Lee, Donggeun Yoo, and In So Kweon. Distort-and-recover: Color enhancement using deep reinforcement learning. In *The IEEE Conference on Computer Vision and Pattern Recognition (CVPR)*, June 2018.
- Paritosh Parmar and Brendan Tran Morris. What and how well you performed? a multitask learning approach to action quality assessment. In *The IEEE Conference on Computer Vision and Pattern Recognition (CVPR)*, June 2019.
- Despoina Paschalidou, Osman Ulusoy, Carolin Schmitt, Luc Van Gool, and Andreas Geiger. Raynet: Learning volumetric 3d reconstruction with ray potentials. In *The IEEE Conference on Computer Vision and Pattern Recognition (CVPR)*, June 2018.
- Despoina Paschalidou, Ali Osman Ulusoy, and Andreas Geiger. Superquadrics revisited: Learning 3d shape parsing beyond cuboids. In *The IEEE Conference on Computer Vision and Pattern Recognition (CVPR)*, June 2019.
- Geoffrey Pascoe, Will Maddern, Michael Tanner, Pedro Pinies, and Paul Newman. Nid-slam: Robust monocular slam using normalised information distance. In *The IEEE Conference on Computer Vision and Pattern Recognition (CVPR)*, July 2017.
- Deepak Pathak, Philipp Krahenbuhl, Jeff Donahue, Trevor Darrell, and Alexei A. Efros. Context encoders: Feature learning by inpainting. In *The IEEE Conference on Computer Vision and Pattern Recognition (CVPR)*, June 2016.
- Deepak Pathak, Ross Girshick, Piotr Dollar, Trevor Darrell, and Bharath Hariharan. Learning features by watching objects move. In *The IEEE Conference on Computer Vision and Pattern Recognition (CVPR)*, July 2017.
- Giorgio Patrini, Alessandro Rozza, Aditya Krishna Menon, Richard Nock, and Lizhen Qu. Making deep neural networks robust to label noise: A loss correction approach. In *The IEEE Conference on Computer Vision and Pattern Recognition (CVPR)*, July 2017.

- Badri Patro and Vinay P. Namboodiri. Differential attention for visual question answering. In *The IEEE Conference on Computer Vision and Pattern Recognition (CVPR)*, June 2018.
- Akanksha Paul, Narayanan C. Krishnan, and Prateek Munjal. Semantically aligned bias reducing zero shot learning. In *The IEEE Conference on Computer Vision and Pattern Recognition (CVPR)*, June 2019.
- Mrinal K. Paul and Stergios I. Roumeliotis. Alternating-stereo vins: Observability analysis and performance evaluation. In *The IEEE Conference on Computer Vision and Pattern Recognition (CVPR)*, June 2018.
- Sujoy Paul, Jawadul H. Bappy, and Amit K. Roy-Chowdhury. Non-uniform subset selection for active learning in structured data. In *The IEEE Conference on Computer Vision and Pattern Recognition (CVPR)*, July 2017.
- Georgios Pavlakos, Xiaowei Zhou, Konstantinos G. Derpanis, and Kostas Daniilidis. Harvesting multiple views for marker-less 3d human pose annotations. In *The IEEE Conference on Computer Vision and Pattern Recognition (CVPR)*, July 2017.
- Georgios Pavlakos, Luyang Zhu, Xiaowei Zhou, and Kostas Daniilidis. Learning to estimate 3d human pose and shape from a single color image. In *The IEEE Conference on Computer Vision and Pattern Recognition (CVPR)*, June 2018.
- Georgios Pavlakos, Vasileios Choutas, Nima Ghorbani, Timo Bolkart, Ahmed A. A. Osman, Dimitrios Tzionas, and Michael J. Black. Expressive body capture: 3d hands, face, and body from a single image. In *The IEEE Conference on Computer Vision and Pattern Recognition (CVPR)*, June 2019.
- Dario Pavllo, Christoph Feichtenhofer, David Grangier, and Michael Auli. 3d human pose estimation in video with temporal convolutions and semi-supervised training. In *The IEEE Conference on Computer Vision and Pattern Recognition (CVPR)*, June 2019.
- Wenjie Pei, Tadas Baltrusaitis, David M.J. Tax, and Louis-Philippe Morency. Temporal attention-gated model for robust sequence classification. In *The IEEE Conference on Computer Vision and Pattern Recognition (CVPR)*, July 2017.
- Wenjie Pei, Jiyuan Zhang, Xiangrong Wang, Lei Ke, Xiaoyong Shen, and Yu-Wing Tai. Memory-attended recurrent network for video captioning. In *The IEEE Conference on Computer Vision and Pattern Recognition (CVPR)*, June 2019.
- Tomer Peleg, Pablo Szekely, Doron Sabo, and Omry Sendik. Im-net for high resolution video frame interpolation. In *The IEEE Conference on Computer Vision and Pattern Recognition (CVPR)*, June 2019.
- Chong Peng, Zhao Kang, and Qiang Cheng. Subspace clustering via variance regularized ridge regression. In *The IEEE Conference on Computer Vision and Pattern Recognition (CVPR)*, July 2017.
- Guozhu Peng and Shangfei Wang. Weakly supervised facial action unit recognition through adversarial training. In *The IEEE Conference on Computer Vision and Pattern Recognition (CVPR)*, June 2018.
- Peixi Peng, Tao Xiang, Yaowei Wang, Massimiliano Pontil, Shaogang Gong, Tiejun Huang, and Yonghong Tian. Unsupervised cross-dataset transfer learning for person re-identification. In *The IEEE Conference on Computer Vision and Pattern Recognition (CVPR)*, June 2016.
- Sida Peng, Yuan Liu, Qixing Huang, Xiaowei Zhou, and Hujun Bao. Pvnnet: Pixel-wise voting network for 6dof pose estimation. In *The IEEE Conference on Computer Vision and Pattern Recognition (CVPR)*, June 2019.
- Federico Perazzi, Jordi Pont-Tuset, Brian McWilliams, Luc Van Gool, Markus Gross, and Alexander Sorkine-Hornung. A benchmark dataset and evaluation methodology for video object segmentation. In *The IEEE Conference on Computer Vision and Pattern Recognition (CVPR)*, June 2016.

- Federico Perazzi, Anna Khoreva, Rodrigo Benenson, Bernt Schiele, and Alexander Sorkine-Hornung. Learning video object segmentation from static images. In *The IEEE Conference on Computer Vision and Pattern Recognition (CVPR)*, July 2017.
- Pramuditha Perera, Ramesh Nallapati, and Bing Xiang. Ocgan: One-class novelty detection using gans with constrained latent representations. In *The IEEE Conference on Computer Vision and Pattern Recognition (CVPR)*, June 2019.
- Eduardo Perez-Pellitero, Jordi Salvador, Javier Ruiz-Hidalgo, and Bodo Rosenhahn. Psycho: Manifold span reduction for super resolution. In *The IEEE Conference on Computer Vision and Pattern Recognition (CVPR)*, June 2016.
- Juan-Manuel Perez-Rua, Tomas Crivelli, Patrick Bouthemy, and Patrick Perez. Determining occlusions from space and time image reconstructions. In *The IEEE Conference on Computer Vision and Pattern Recognition (CVPR)*, June 2016.
- Juan-Manuel Perez-Rua, Valentin Vielzeuf, Stephane Pateux, Moez Baccouche, and Frederic Jurie. Mfas: Multimodal fusion architecture search. In *The IEEE Conference on Computer Vision and Pattern Recognition (CVPR)*, June 2019.
- Federico Pernici, Federico Bartoli, Matteo Bruni, and Alberto Del Bimbo. Memory based online learning of deep representations from video streams. In *The IEEE Conference on Computer Vision and Pattern Recognition (CVPR)*, June 2018.
- Toby Perrett and Dima Damen. Ddlstm: Dual-domain lstm for cross-dataset action recognition. In *The IEEE Conference on Computer Vision and Pattern Recognition (CVPR)*, June 2019.
- Quang-Hieu Pham, Thanh Nguyen, Binh-Son Hua, Gemma Roig, and Sai-Kit Yeung. Jsis3d: Joint semantic-instance segmentation of 3d point clouds with multi-task pointwise networks and multi-value conditional random fields. In *The IEEE Conference on Computer Vision and Pattern Recognition (CVPR)*, June 2019.
- Trung T. Pham, Seyed Hamid Rezatofighi, Ian Reid, and Tat-Jun Chin. Efficient point process inference for large-scale object detection. In *The IEEE Conference on Computer Vision and Pattern Recognition (CVPR)*, June 2016.
- Jonah Philion. Fastdraw: Addressing the long tail of lane detection by adapting a sequential prediction network. In *The IEEE Conference on Computer Vision and Pattern Recognition (CVPR)*, June 2019.
- Xinglin Piao, Yongli Hu, Junbin Gao, Yanfeng Sun, and Baocai Yin. Double nuclear norm based low rank representation on grassmann manifolds for clustering. In *The IEEE Conference on Computer Vision and Pattern Recognition (CVPR)*, June 2019.
- AJ Piergiovanni and Michael S. Ryoo. Learning latent super-events to detect multiple activities in videos. In *The IEEE Conference on Computer Vision and Pattern Recognition (CVPR)*, June 2018.
- AJ Piergiovanni and Michael S. Ryoo. Representation flow for action recognition. In *The IEEE Conference on Computer Vision and Pattern Recognition (CVPR)*, June 2019.
- Andrea Pilzer, Stephane Lathuiliere, Nicu Sebe, and Elisa Ricci. Refine and distill: Exploiting cycle-inconsistency and knowledge distillation for unsupervised monocular depth estimation. In *The IEEE Conference on Computer Vision and Pattern Recognition (CVPR)*, June 2019.
- Pedro O. Pinheiro. Unsupervised domain adaptation with similarity learning. In *The IEEE Conference on Computer Vision and Pattern Recognition (CVPR)*, June 2018.
- Marcel Pietraschke and Volker Blanz. Automated 3d face reconstruction from multiple images using quality measures. In *The IEEE Conference on Computer Vision and Pattern Recognition (CVPR)*, June 2016.

- Aleksis Pirinen and Cristian Sminchisescu. Deep reinforcement learning of region proposal networks for object detection. In *The IEEE Conference on Computer Vision and Pattern Recognition (CVPR)*, June 2018.
- Leonid Pishchulin, Eldar Insafutdinov, Siyu Tang, Bjoern Andres, Mykhaylo Andriluka, Peter V. Gehler, and Bernt Schiele. Deepcut: Joint subset partition and labeling for multi person pose estimation. In *The IEEE Conference on Computer Vision and Pattern Recognition (CVPR)*, June 2016.
- Francesco Pittaluga, Sanjeev J. Koppal, Sing Bing Kang, and Sudipta N. Sinha. Revealing scenes by inverting structure from motion reconstructions. In *The IEEE Conference on Computer Vision and Pattern Recognition (CVPR)*, June 2019.
- Tobias Plotz and Stefan Roth. Benchmarking denoising algorithms with real photographs. In *The IEEE Conference on Computer Vision and Pattern Recognition (CVPR)*, July 2017.
- Stylios Ploumpis, Haoyang Wang, Nick Pears, William A. P. Smith, and Stefanos Zafeiriou. Combining 3d morphable models: A large scale face-and-head model. In *The IEEE Conference on Computer Vision and Pattern Recognition (CVPR)*, June 2019.
- Bryan A. Plummer, Matthew Brown, and Svetlana Lazebnik. Enhancing video summarization via vision-language embedding. In *The IEEE Conference on Computer Vision and Pattern Recognition (CVPR)*, July 2017.
- Matteo Poggi and Stefano Mattoccia. Learning to predict stereo reliability enforcing local consistency of confidence maps. In *The IEEE Conference on Computer Vision and Pattern Recognition (CVPR)*, July 2017.
- Matteo Poggi, Davide Pallotti, Fabio Tosi, and Stefano Mattoccia. Guided stereo matching. In *The IEEE Conference on Computer Vision and Pattern Recognition (CVPR)*, June 2019.
- Tobias Pohlen, Alexander Hermans, Markus Mathias, and Bastian Leibe. Full-resolution residual networks for semantic segmentation in street scenes. In *The IEEE Conference on Computer Vision and Pattern Recognition (CVPR)*, July 2017.
- Georg Poier, David Schinagl, and Horst Bischof. Learning pose specific representations by predicting different views. In *The IEEE Conference on Computer Vision and Pattern Recognition (CVPR)*, June 2018.
- Alex Poms, Chenglei Wu, Shoou-I Yu, and Yaser Sheikh. Learning patch reconstructability for accelerating multi-view stereo. In *The IEEE Conference on Computer Vision and Pattern Recognition (CVPR)*, June 2018.
- Alin-Ionut Popa, Mihai Zanfir, and Cristian Sminchisescu. Deep multitask architecture for integrated 2d and 3d human sensing. In *The IEEE Conference on Computer Vision and Pattern Recognition (CVPR)*, July 2017.
- Phillip E. Pope, Soheil Kolouri, Mohammad Rostami, Charles E. Martin, and Heiko Hoffmann. Explainability methods for graph convolutional neural networks. In *The IEEE Conference on Computer Vision and Pattern Recognition (CVPR)*, June 2019.
- Lorenzo Porzi, Samuel Rota Buló, Aleksander Colovic, and Peter Kotschieder. Seamless scene segmentation. In *The IEEE Conference on Computer Vision and Pattern Recognition (CVPR)*, June 2019.
- Rafael Possas, Sheila Pinto Caceres, and Fabio Ramos. Egocentric activity recognition on a budget. In *The IEEE Conference on Computer Vision and Pattern Recognition (CVPR)*, June 2018.
- Omid Poursaeed, Isay Katsman, Bicheng Gao, and Serge Belongie. Generative adversarial perturbations. In *The IEEE Conference on Computer Vision and Pattern Recognition (CVPR)*, June 2018.
- Arik Poznanski and Lior Wolf. Cnn-n-gram for handwriting word recognition. In *The IEEE Conference on Computer Vision and Pattern Recognition (CVPR)*, June 2016.

- Aaditya Prakash, Nick Moran, Solomon Garber, Antonella DiLillo, and James Storer. Deflecting adversarial attacks with pixel deflection. In *The IEEE Conference on Computer Vision and Pattern Recognition (CVPR)*, June 2018.
- Aaditya Prakash, James Storer, Dinei Florencio, and Cha Zhang. Repr: Improved training of convolutional filters. In *The IEEE Conference on Computer Vision and Pattern Recognition (CVPR)*, June 2019.
- R. T. Pramod and S. P. Arun. Do computational models differ systematically from human object perception? In *The IEEE Conference on Computer Vision and Pattern Recognition (CVPR)*, June 2016.
- Ekta Prashnani, Hong Cai, Yasamin Mostofi, and Pradeep Sen. Pieapp: Perceptual image-error assessment through pairwise preference. In *The IEEE Conference on Computer Vision and Pattern Recognition (CVPR)*, June 2018.
- True Price, Johannes L. Schönberger, Zhen Wei, Marc Pollefeys, and Jan-Michael Frahm. Augmenting crowd-sourced 3d reconstructions using semantic detections. In *The IEEE Conference on Computer Vision and Pattern Recognition (CVPR)*, June 2018.
- James Pritts, Zuzana Kukelova, Viktor Larsson, and Ondřej Chum. Radially-distorted conjugate translations. In *The IEEE Conference on Computer Vision and Pattern Recognition (CVPR)*, June 2018.
- Thomas Probst, Danda Pani Paudel, Ajad Chhatkuli, and Luc Van Gool. Unsupervised learning of consensus maximization for 3d vision problems. In *The IEEE Conference on Computer Vision and Pattern Recognition (CVPR)*, June 2019.
- Hugo Proenca and Joao C. Neves. Irina: Iris recognition (even) in inaccurately segmented data. In *The IEEE Conference on Computer Vision and Pattern Recognition (CVPR)*, July 2017.
- Junfu Pu, Wengang Zhou, and Houqiang Li. Iterative alignment network for continuous sign language recognition. In *The IEEE Conference on Computer Vision and Pattern Recognition (CVPR)*, June 2019.
- Xavier Puig, Kevin Ra, Marko Boben, Jiaman Li, Tingwu Wang, Sanja Fidler, and Antonio Torralba. Virtualhome: Simulating household activities via programs. In *The IEEE Conference on Computer Vision and Pattern Recognition (CVPR)*, June 2018.
- Albert Pumarola, Antonio Agudo, Lorenzo Porzi, Alberto Sanfeliu, Vincent Lepetit, and Francesc Moreno-Noguer. Geometry-aware network for non-rigid shape prediction from a single view. In *The IEEE Conference on Computer Vision and Pattern Recognition (CVPR)*, June 2018.
- Abhijith Punnappurath and Michael S. Brown. Reflection removal using a dual-pixel sensor. In *The IEEE Conference on Computer Vision and Pattern Recognition (CVPR)*, June 2019.
- Kuldeep Purohit, Anshul Shah, and A. N. Rajagopalan. Bringing alive blurred moments. In *The IEEE Conference on Computer Vision and Pattern Recognition (CVPR)*, June 2019.
- Gilles Puy and Patrick Perez. A flexible convolutional solver for fast style transfers. In *The IEEE Conference on Computer Vision and Pattern Recognition (CVPR)*, June 2019.
- Charles R. Qi, Hao Su, Kaichun Mo, and Leonidas J. Guibas. Pointnet: Deep learning on point sets for 3d classification and segmentation. In *The IEEE Conference on Computer Vision and Pattern Recognition (CVPR)*, July 2017.
- Guo-Jun Qi. Hierarchically gated deep networks for semantic segmentation. In *The IEEE Conference on Computer Vision and Pattern Recognition (CVPR)*, June 2016.
- Lu Qi, Li Jiang, Shu Liu, Xiaoyong Shen, and Jiaya Jia. Amodal instance segmentation with kins dataset. In *The IEEE Conference on Computer Vision and Pattern Recognition (CVPR)*, June 2019.

- Xiaojuan Qi, Renjie Liao, Zhengzhe Liu, Raquel Urtasun, and Jiaya Jia. Geonet: Geometric neural network for joint depth and surface normal estimation. In *The IEEE Conference on Computer Vision and Pattern Recognition (CVPR)*, June 2018.
- Rui Qian, Robby T. Tan, Wenhan Yang, Jiajun Su, and Jiaying Liu. Attentive generative adversarial network for raindrop removal from a single image. In *The IEEE Conference on Computer Vision and Pattern Recognition (CVPR)*, June 2018.
- Yanlin Qian, Joni-Kristian Kamarainen, Jarno Nikkanen, and Jiri Matas. On finding gray pixels. In *The IEEE Conference on Computer Vision and Pattern Recognition (CVPR)*, June 2019.
- Yiming Qian, Minglun Gong, and Yee Hong Yang. 3d reconstruction of transparent objects with position-normal consistency. In *The IEEE Conference on Computer Vision and Pattern Recognition (CVPR)*, June 2016.
- Yiming Qian, Minglun Gong, and Yee-Hong Yang. Stereo-based 3d reconstruction of dynamic fluid surfaces by global optimization. In *The IEEE Conference on Computer Vision and Pattern Recognition (CVPR)*, July 2017.
- Ruizhi Qiao, Lingqiao Liu, Chunhua Shen, and Anton van den Hengel. Less is more: Zero-shot learning from online textual documents with noise suppression. In *The IEEE Conference on Computer Vision and Pattern Recognition (CVPR)*, June 2016.
- Siyuan Qiao, Chenxi Liu, Wei Shen, and Alan L. Yuille. Few-shot image recognition by predicting parameters from activations. In *The IEEE Conference on Computer Vision and Pattern Recognition (CVPR)*, June 2018.
- Siyuan Qiao, Zhe Lin, Jianming Zhang, and Alan L. Yuille. Neural rejuvenation: Improving deep network training by enhancing computational resource utilization. In *The IEEE Conference on Computer Vision and Pattern Recognition (CVPR)*, June 2019.
- Hongwei Qin, Junjie Yan, Xiu Li, and Xiaolin Hu. Joint training of cascaded cnn for face detection. In *The IEEE Conference on Computer Vision and Pattern Recognition (CVPR)*, June 2016.
- Jie Qin, Li Liu, Ling Shao, Bingbing Ni, Chen Chen, Fumin Shen, and Yunhong Wang. Binary coding for partial action analysis with limited observation ratios. In *The IEEE Conference on Computer Vision and Pattern Recognition (CVPR)*, July 2017.
- Xuebin Qin, Zichen Zhang, Chenyang Huang, Chao Gao, Masood Dehghan, and Martin Jagersand. Basnet: Boundary-aware salient object detection. In *The IEEE Conference on Computer Vision and Pattern Recognition (CVPR)*, June 2019.
- Jiaxiong Qiu, Zhaopeng Cui, Yinda Zhang, Xingdi Zhang, Shuaicheng Liu, Bing Zeng, and Marc Pollefeys. Deeplidar: Deep surface normal guided depth prediction for outdoor scene from sparse lidar data and single color image. In *The IEEE Conference on Computer Vision and Pattern Recognition (CVPR)*, June 2019.
- Zhaofan Qiu, Ting Yao, and Tao Mei. Deep quantization: Encoding convolutional activations with deep generative model. In *The IEEE Conference on Computer Vision and Pattern Recognition (CVPR)*, July 2017.
- Liangqiong Qu, Jiandong Tian, Shengfeng He, Yandong Tang, and Rynson W. H. Lau. Deshadownet: A multi-context embedding deep network for shadow removal. In *The IEEE Conference on Computer Vision and Pattern Recognition (CVPR)*, July 2017.
- Yanyun Qu, Yizi Chen, Jingying Huang, and Yuan Xie. Enhanced pix2pix dehazing network. In *The IEEE Conference on Computer Vision and Pattern Recognition (CVPR)*, June 2019.
- Ying Qu, Hairong Qi, and Chiman Kwan. Unsupervised sparse dirichlet-net for hyperspectral image super-resolution. In *The IEEE Conference on Computer Vision and Pattern Recognition (CVPR)*, June 2018.

- Novi Quadrianto, Viktoriia Sharmanska, and Oliver Thomas. Discovering fair representations in the data domain. In *The IEEE Conference on Computer Vision and Pattern Recognition (CVPR)*, June 2019.
- Yuhui Quan, Chenglong Bao, and Hui Ji. Equiangular kernel dictionary learning with applications to dynamic texture analysis. In *The IEEE Conference on Computer Vision and Pattern Recognition (CVPR)*, June 2016.
- Ha Quang Minh, Marco San Biagio, Loris Bazzani, and Vittorio Murino. Approximate log-hilbertschmidt distances between covariance operators for image classification. In *The IEEE Conference on Computer Vision and Pattern Recognition (CVPR)*, June 2016.
- Yvain Queau, Roberto Mecca, and Jean-Denis Durou. Unbiased photometric stereo for colored surfaces: A variational approach. In *The IEEE Conference on Computer Vision and Pattern Recognition (CVPR)*, June 2016.
- Yvain Queau, Tao Wu, Francois Lauze, Jean-Denis Durou, and Daniel Cremers. A non-convex variational approach to photometric stereo under inaccurate lighting. In *The IEEE Conference on Computer Vision and Pattern Recognition (CVPR)*, July 2017.
- Thi Quynh Nhi Tran, Herve Le Borgne, and Michel Crucianu. Aggregating image and text quantized correlated components. In *The IEEE Conference on Computer Vision and Pattern Recognition (CVPR)*, June 2016.
- Yaadhav Raaj, Haroon Idrees, Gines Hidalgo, and Yaser Sheikh. Efficient online multi-person 2d pose tracking with recurrent spatio-temporal affinity fields. In *The IEEE Conference on Computer Vision and Pattern Recognition (CVPR)*, June 2019.
- Mahdi Rad, Markus Oberweger, and Vincent Lepetit. Feature mapping for learning fast and accurate 3d pose inference from synthetic images. In *The IEEE Conference on Computer Vision and Pattern Recognition (CVPR)*, June 2018.
- Filip Radenovic, Johannes L. Schonberger, Dinghuang Ji, Jan-Michael Frahm, Ondrej Chum, and Jiri Matas. From dusk till dawn: Modeling in the dark. In *The IEEE Conference on Computer Vision and Pattern Recognition (CVPR)*, June 2016.
- Ilija Radosavovic, Piotr Dollár, Ross Girshick, Georgia Gkioxari, and Kaiming He. Data distillation: Towards omni-supervised learning. In *The IEEE Conference on Computer Vision and Pattern Recognition (CVPR)*, June 2018.
- Edward Raff, Jared Sylvester, Steven Forsyth, and Mark McLean. Barrage of random transforms for adversarially robust defense. In *The IEEE Conference on Computer Vision and Pattern Recognition (CVPR)*, June 2019.
- Amir M. Rahimi, Raphael Ruschel, and B.S. Manjunath. Uav sensor fusion with latent-dynamic conditional random fields in coronal plane estimation. In *The IEEE Conference on Computer Vision and Pattern Recognition (CVPR)*, June 2016.
- Hossein Rahmani and Ajmal Mian. 3d action recognition from novel viewpoints. In *The IEEE Conference on Computer Vision and Pattern Recognition (CVPR)*, June 2016.
- Jathushan Rajasegaran, Vinoj Jayasundara, Sandaru Jayasekara, Hirunima Jayasekara, Suranga Seneviratne, and Ranga Rodrigo. Deepcaps: Going deeper with capsule networks. In *The IEEE Conference on Computer Vision and Pattern Recognition (CVPR)*, June 2019.
- Santhosh K. Ramakrishnan, Ambar Pal, Gaurav Sharma, and Anurag Mittal. An empirical evaluation of visual question answering for novel objects. In *The IEEE Conference on Computer Vision and Pattern Recognition (CVPR)*, July 2017.
- Vignesh Ramanathan, Jonathan Huang, Sami Abu-El-Haija, Alexander Gorban, Kevin Murphy, and Li Fei-Fei. Detecting events and key actors in multi-person videos. In *The IEEE Conference on Computer Vision and Pattern Recognition (CVPR)*. June 2016.

- Vasili Ramanishka, Abir Das, Jianming Zhang, and Kate Saenko. Top-down visual saliency guided by captions. In *The IEEE Conference on Computer Vision and Pattern Recognition (CVPR)*, July 2017.
- Vasili Ramanishka, Yi-Ting Chen, Teruhisa Misu, and Kate Saenko. Toward driving scene understanding: A dataset for learning driver behavior and causal reasoning. In *The IEEE Conference on Computer Vision and Pattern Recognition (CVPR)*, June 2018.
- Rene Ranftl, Vibhav Vineet, Qifeng Chen, and Vladlen Koltun. Dense monocular depth estimation in complex dynamic scenes. In *The IEEE Conference on Computer Vision and Pattern Recognition (CVPR)*, June 2016.
- Anurag Ranjan and Michael J. Black. Optical flow estimation using a spatial pyramid network. In *The IEEE Conference on Computer Vision and Pattern Recognition (CVPR)*, July 2017.
- Anurag Ranjan, Varun Jampani, Lukas Balles, Kihwan Kim, Deqing Sun, Jonas Wulff, and Michael J. Black. Competitive collaboration: Joint unsupervised learning of depth, camera motion, optical flow and motion segmentation. In *The IEEE Conference on Computer Vision and Pattern Recognition (CVPR)*, June 2019.
- Yongming Rao, Dahua Lin, Jiwen Lu, and Jie Zhou. Learning globally optimized object detector via policy gradient. In *The IEEE Conference on Computer Vision and Pattern Recognition (CVPR)*, June 2018.
- Yongming Rao, Jiwen Lu, and Jie Zhou. Spherical fractal convolutional neural networks for point cloud recognition. In *The IEEE Conference on Computer Vision and Pattern Recognition (CVPR)*, June 2019.
- Koteswar Rao Jerripothula, Jianfei Cai, Jiangbo Lu, and Junsong Yuan. Object co-skeletonization with co-segmentation. In *The IEEE Conference on Computer Vision and Pattern Recognition (CVPR)*, July 2017.
- Carolina Raposo and Joao P. Barreto. Theory and practice of structure-from-motion using affine correspondences. In *The IEEE Conference on Computer Vision and Pattern Recognition (CVPR)*, June 2016.
- Carolina Raposo and João P. Barreto. 3d registration of curves and surfaces using local differential information. In *The IEEE Conference on Computer Vision and Pattern Recognition (CVPR)*, June 2018.
- Maheen Rashid, Xiuye Gu, and Yong Jae Lee. Interspecies knowledge transfer for facial keypoint detection. In *The IEEE Conference on Computer Vision and Pattern Recognition (CVPR)*, July 2017.
- Sarah Rastegar, Mahdieh Soleymani, Hamid R. Rabiee, and Seyed Mohsen Shojaee. Mdl-cw: A multimodal deep learning framework with cross weights. In *The IEEE Conference on Computer Vision and Pattern Recognition (CVPR)*, June 2016.
- Hareesh Ravi, Lezi Wang, Carlos Muniz, Leonid Sigal, Dimitris Metaxas, and Mubbasir Kapadia. Show me a story: Towards coherent neural story illustration. In *The IEEE Conference on Computer Vision and Pattern Recognition (CVPR)*, June 2018.
- Sathya N. Ravi, Yunyang Xiong, Lopamudra Mukherjee, and Vikas Singh. Filter flow made practical: Massively parallel and lock-free. In *The IEEE Conference on Computer Vision and Pattern Recognition (CVPR)*, July 2017.
- Swarna K. Ravindran and Anurag Mittal. Comal: Good features to match on object boundaries. In *The IEEE Conference on Computer Vision and Pattern Recognition (CVPR)*, June 2016.
- Esteban Real, Jonathon Shlens, Stefano Mazzocchi, Xin Pan, and Vincent Vanhoucke. Youtube-boundingboxes: A large high-precision human-annotated data set for object detection in video. In *The IEEE Conference on Computer Vision and Pattern Recognition (CVPR)*, July 2017.

- Henri Rebecq, Rene Ranftl, Vladlen Koltun, and Davide Scaramuzza. Events-to-video: Bringing modern computer vision to event cameras. In *The IEEE Conference on Computer Vision and Pattern Recognition (CVPR)*, June 2019.
- Sylvestre-Alvise Rebuffi, Alexander Kolesnikov, Georg Sperl, and Christoph H. Lampert. icarl: Incremental classifier and representation learning. In *The IEEE Conference on Computer Vision and Pattern Recognition (CVPR)*, July 2017.
- Sylvestre-Alvise Rebuffi, Hakan Bilen, and Andrea Vedaldi. Efficient parametrization of multi-domain deep neural networks. In *The IEEE Conference on Computer Vision and Pattern Recognition (CVPR)*, June 2018.
- N. Dinesh Reddy, Minh Vo, and Srinivasa G. Narasimhan. Occlusion-net: 2d/3d occluded keypoint localization using graph networks. In *The IEEE Conference on Computer Vision and Pattern Recognition (CVPR)*, June 2019.
- Konda Reddy Mopuri, Utkarsh Ojha, Utsav Garg, and R. Venkatesh Babu. Nag: Network for adversary generation. In *The IEEE Conference on Computer Vision and Pattern Recognition (CVPR)*, June 2018.
- Joseph Redmon and Ali Farhadi. Yolo9000: Better, faster, stronger. In *The IEEE Conference on Computer Vision and Pattern Recognition (CVPR)*, July 2017.
- Joseph Redmon, Santosh Divvala, Ross Girshick, and Ali Farhadi. You only look once: Unified, real-time object detection. In *The IEEE Conference on Computer Vision and Pattern Recognition (CVPR)*, June 2016.
- Scott Reed, Zeynep Akata, Honglak Lee, and Bernt Schiele. Learning deep representations of fine-grained visual descriptions. In *The IEEE Conference on Computer Vision and Pattern Recognition (CVPR)*, June 2016.
- Krishna Regmi and Ali Borji. Cross-view image synthesis using conditional gans. In *The IEEE Conference on Computer Vision and Pattern Recognition (CVPR)*, June 2018.
- Konstantinos Rematas, Tobias Ritschel, Mario Fritz, Efstratios Gavves, and Tinne Tuytelaars. Deep reflectance maps. In *The IEEE Conference on Computer Vision and Pattern Recognition (CVPR)*, June 2016.
- Konstantinos Rematas, Ira Kemelmacher-Shlizerman, Brian Curless, and Steve Seitz. Soccer on your tabletop. In *The IEEE Conference on Computer Vision and Pattern Recognition (CVPR)*, June 2018.
- Dongwei Ren, Wangmeng Zuo, Qinghua Hu, Pengfei Zhu, and Deyu Meng. Progressive image deraining networks: A better and simpler baseline. In *The IEEE Conference on Computer Vision and Pattern Recognition (CVPR)*, June 2019.
- Zhile Ren and Erik B. Sudderth. Three-dimensional object detection and layout prediction using clouds of oriented gradients. In *The IEEE Conference on Computer Vision and Pattern Recognition (CVPR)*, June 2016.
- Zhongzheng Ren and Yong Jae Lee. Cross-domain self-supervised multi-task feature learning using synthetic imagery. In *The IEEE Conference on Computer Vision and Pattern Recognition (CVPR)*, June 2018.
- Zhou Ren, Xiaoyu Wang, Ning Zhang, Xutao Lv, and Li-Jia Li. Deep reinforcement learning-based image captioning with embedding reward. In *The IEEE Conference on Computer Vision and Pattern Recognition (CVPR)*, July 2017.
- Vijay Rengarajan, Ambasadram N. Rajagopalan, and Rangarajan Aravind. From bows to arrows: Rolling shutter rectification of urban scenes. In *The IEEE Conference on Computer Vision and Pattern Recognition (CVPR)*, June 2016.

- Vijay Rengarajan, Yogesh Balaji, and A. N. Rajagopalan. Unrolling the shutter: Cnn to correct motion distortions. In *The IEEE Conference on Computer Vision and Pattern Recognition (CVPR)*, July 2017.
- Steven J. Rennie, Etienne Marcheret, Youssef Mroueh, Jerret Ross, and Vaibhava Goel. Self-critical sequence training for image captioning. In *The IEEE Conference on Computer Vision and Pattern Recognition (CVPR)*, July 2017.
- George Retsinas, Georgios Louloudis, Nikolaos Stamatopoulos, Giorgos Sfikas, and Basilis Gatos. An alternative deep feature approach to line level keyword spotting. In *The IEEE Conference on Computer Vision and Pattern Recognition (CVPR)*, June 2019.
- Jerome Revaud, Minhyeok Heo, Rafael S. Rezende, Chanmi You, and Seong-Gyun Jeong. Did it change? learning to detect point-of-interest changes for proactive map updates. In *The IEEE Conference on Computer Vision and Pattern Recognition (CVPR)*, June 2019.
- Morteza Rezanejad, Gabriel Downs, John Wilder, Dirk B. Walther, Allan Jepson, Sven Dickinson, and Kaleem Siddiqi. Scene categorization from contours: Medial axis based saliency measures. In *The IEEE Conference on Computer Vision and Pattern Recognition (CVPR)*, June 2019.
- Hamid Rezatofighi, Nathan Tsoi, JunYoung Gwak, Amir Sadeghian, Ian Reid, and Silvio Savarese. Generalized intersection over union: A metric and a loss for bounding box regression. In *The IEEE Conference on Computer Vision and Pattern Recognition (CVPR)*, June 2019.
- Rafael S. Rezende, Joaquin Zepeda, Jean Ponce, Francis Bach, and Patrick Perez. Kernel square-loss exemplar machines for image retrieval. In *The IEEE Conference on Computer Vision and Pattern Recognition (CVPR)*, July 2017.
- Nicholas Rhinehart and Kris M. Kitani. Learning action maps of large environments via first-person vision. In *The IEEE Conference on Computer Vision and Pattern Recognition (CVPR)*, June 2016.
- Helge Rhodin, Jörg Spörri, Isinsu Katircioglu, Victor Constantin, Frédéric Meyer, Erich Müller, Mathieu Salzmann, and Pascal Fua. Learning monocular 3d human pose estimation from multi-view images. In *The IEEE Conference on Computer Vision and Pattern Recognition (CVPR)*, June 2018.
- Helge Rhodin, Victor Constantin, Isinsu Katircioglu, Mathieu Salzmann, and Pascal Fua. Neural scene decomposition for multi-person motion capture. In *The IEEE Conference on Computer Vision and Pattern Recognition (CVPR)*, June 2019.
- Umar Riaz Muhammad, Yongxin Yang, Yi-Zhe Song, Tao Xiang, and Timothy M. Hospedales. Learning deep sketch abstraction. In *The IEEE Conference on Computer Vision and Pattern Recognition (CVPR)*, June 2018.
- Javier Ribera, David Guera, Yuhao Chen, and Edward J. Delp. Locating objects without bounding boxes. In *The IEEE Conference on Computer Vision and Pattern Recognition (CVPR)*, June 2019.
- Alexander Richard and Juergen Gall. Temporal action detection using a statistical language model. In *The IEEE Conference on Computer Vision and Pattern Recognition (CVPR)*, June 2016.
- Alexander Richard, Hilde Kuehne, and Juergen Gall. Weakly supervised action learning with rnn based fine-to-coarse modeling. In *The IEEE Conference on Computer Vision and Pattern Recognition (CVPR)*, July 2017.
- Alexander Richard, Hilde Kuehne, and Juergen Gall. Action sets: Weakly supervised action segmentation without ordering constraints. In *The IEEE Conference on Computer Vision and Pattern Recognition (CVPR)*, June 2018.
- Elad Richardson, Matan Sela, Roy Or-El, and Ron Kimmel. Learning detailed face reconstruction from a single image. In *The IEEE Conference on Computer Vision and Pattern Recognition (CVPR)*, July 2017.
- Stephan R. Richter and Stefan Roth. Matryoshka networks: Predicting 3d geometry via nested shape layers. In *The IEEE Conference on Computer Vision and Pattern Recognition (CVPR)*, June 2018.

- Gernot Riegler, Ali Osman Ulusoy, and Andreas Geiger. Octnet: Learning deep 3d representations at high resolutions. In *The IEEE Conference on Computer Vision and Pattern Recognition (CVPR)*, July 2017.
- Gernot Riegler, Yiyi Liao, Simon Donne, Vladlen Koltun, and Andreas Geiger. Connecting the dots: Learning representations for active monocular depth estimation. In *The IEEE Conference on Computer Vision and Pattern Recognition (CVPR)*, June 2019.
- Ergys Ristani and Carlo Tomasi. Features for multi-target multi-camera tracking and re-identification. In *The IEEE Conference on Computer Vision and Pattern Recognition (CVPR)*, June 2018.
- Daniel Ritchie, Kai Wang, and Yu-An Lin. Fast and flexible indoor scene synthesis via deep convolutional generative models. In *The IEEE Conference on Computer Vision and Pattern Recognition (CVPR)*, June 2019.
- Cesar Roberto de Souza, Adrien Gaidon, Yohann Cabon, and Antonio Manuel Lopez. Procedural generation of videos to train deep action recognition networks. In *The IEEE Conference on Computer Vision and Pattern Recognition (CVPR)*, July 2017.
- Caleb Robinson, Le Hou, Kolya Malkin, Rachel Soobitsky, Jacob Czawlytko, Bistra Dilkina, and Nebojsa Jojic. Large scale high-resolution land cover mapping with multi-resolution data. In *The IEEE Conference on Computer Vision and Pattern Recognition (CVPR)*, June 2019.
- Ignacio Rocco, Relja Arandjelovic, and Josef Sivic. Convolutional neural network architecture for geometric matching. In *The IEEE Conference on Computer Vision and Pattern Recognition (CVPR)*, July 2017.
- Ignacio Rocco, Relja Arandjelović, and Josef Sivic. End-to-end weakly-supervised semantic alignment. In *The IEEE Conference on Computer Vision and Pattern Recognition (CVPR)*, June 2018.
- Mrigank Rochan and Yang Wang. Video summarization by learning from unpaired data. In *The IEEE Conference on Computer Vision and Pattern Recognition (CVPR)*, June 2019.
- Gregory Rogez, Philippe Weinzaepfel, and Cordelia Schmid. Lcr-net: Localization-classification-regression for human pose. In *The IEEE Conference on Computer Vision and Pattern Recognition (CVPR)*, July 2017.
- Anna Rohrbach, Marcus Rohrbach, Siyu Tang, Seong Joon Oh, and Bernt Schiele. Generating descriptions with grounded and co-referenced people. In *The IEEE Conference on Computer Vision and Pattern Recognition (CVPR)*, July 2017.
- Michal Rolinek, Dominik Zietlow, and Georg Martius. Variational autoencoders pursue pca directions (by accident). In *The IEEE Conference on Computer Vision and Pattern Recognition (CVPR)*, June 2019.
- Xuejian Rong, Chucai Yi, and Yingli Tian. Unambiguous text localization and retrieval for cluttered scenes. In *The IEEE Conference on Computer Vision and Pattern Recognition (CVPR)*, July 2017.
- Jerome Rony, Luiz G. Hafemann, Luiz S. Oliveira, Ismail Ben Ayed, Robert Sabourin, and Eric Granger. Decoupling direction and norm for efficient gradient-based l2 adversarial attacks and defenses. In *The IEEE Conference on Computer Vision and Pattern Recognition (CVPR)*, June 2019.
- German Ros, Laura Sellart, Joanna Materzynska, David Vazquez, and Antonio M. Lopez. The synthia dataset: A large collection of synthetic images for semantic segmentation of urban scenes. In *The IEEE Conference on Computer Vision and Pattern Recognition (CVPR)*, June 2016.
- Guy Rosman, Daniela Rus, and John W. Fisher, III. Information-driven adaptive structured-light scanners. In *The IEEE Conference on Computer Vision and Pattern Recognition (CVPR)*, June 2016.
- Samuel Rota Buló and Peter Kotschieder. Online learning with bayesian classification trees. In *The IEEE Conference on Computer Vision and Pattern Recognition (CVPR)*, June 2016.

- Samuel Rota Buló, Gerhard Neuhold, and Peter Kotschieder. Loss max-pooling for semantic image segmentation. In *The IEEE Conference on Computer Vision and Pattern Recognition (CVPR)*, July 2017.
- Joseph Roth, Yiying Tong, and Xiaoming Liu. Adaptive 3d face reconstruction from unconstrained photo collections. In *The IEEE Conference on Computer Vision and Pattern Recognition (CVPR)*, June 2016.
- Rasmus Rothe, Radu Timofte, and Luc Van Gool. Some like it hot - visual guidance for preference prediction. In *The IEEE Conference on Computer Vision and Pattern Recognition (CVPR)*, June 2016.
- Tamar Rott Shaham and Tomer Michaeli. Deformation aware image compression. In *The IEEE Conference on Computer Vision and Pattern Recognition (CVPR)*, June 2018.
- Riccardo Roveri, Lukas Rahmann, Cengiz Oztireli, and Markus Gross. A network architecture for point cloud classification via automatic depth images generation. In *The IEEE Conference on Computer Vision and Pattern Recognition (CVPR)*, June 2018.
- Anirban Roy and Sinisa Todorovic. Monocular depth estimation using neural regression forest. In *The IEEE Conference on Computer Vision and Pattern Recognition (CVPR)*, June 2016.
- Anirban Roy and Sinisa Todorovic. Combining bottom-up, top-down, and smoothness cues for weakly supervised image segmentation. In *The IEEE Conference on Computer Vision and Pattern Recognition (CVPR)*, July 2017.
- Proteek Chandan Roy and Vishnu Naresh Boddeti. Mitigating information leakage in image representations: A maximum entropy approach. In *The IEEE Conference on Computer Vision and Pattern Recognition (CVPR)*, June 2019.
- Aruni RoyChowdhury, Prithvijit Chakrabarty, Ashish Singh, SouYoung Jin, Huaizu Jiang, Liangliang Cao, and Erik Learned-Miller. Automatic adaptation of object detectors to new domains using self-training. In *The IEEE Conference on Computer Vision and Pattern Recognition (CVPR)*, June 2019.
- Loic A. Royer, David L. Richmond, Carsten Rother, Bjoern Andres, and Dagmar Kainmueller. Convexity shape constraints for image segmentation. In *The IEEE Conference on Computer Vision and Pattern Recognition (CVPR)*, June 2016.
- Artem Rozantsev, Sudipta N. Sinha, Debadepta Dey, and Pascal Fua. Flight dynamics-based recovery of a uav trajectory using ground cameras. In *The IEEE Conference on Computer Vision and Pattern Recognition (CVPR)*, July 2017.
- Artem Rozantsev, Mathieu Salzmann, and Pascal Fua. Residual parameter transfer for deep domain adaptation. In *The IEEE Conference on Computer Vision and Pattern Recognition (CVPR)*, June 2018.
- Denys Rozumnyi, Jan Kotera, Filip Sroubek, Lukas Novotny, and Jiri Matas. The world of fast moving objects. In *The IEEE Conference on Computer Vision and Pattern Recognition (CVPR)*, July 2017.
- Tom F. H. Runia, Cees G. M. Snoek, and Arnold W. M. Smeulders. Real-world repetition estimation by div, grad and curl. In *The IEEE Conference on Computer Vision and Pattern Recognition (CVPR)*, June 2018.
- Christian Rupprecht, Iro Laina, Nassir Navab, Gregory D. Hager, and Federico Tombari. Guide me: Interacting with deep networks. In *The IEEE Conference on Computer Vision and Pattern Recognition (CVPR)*, June 2018.
- Paolo Russo, Fabio M. Carlucci, Tatiana Tommasi, and Barbara Caputo. From source to target and back: Symmetric bi-directional adaptive gan. In *The IEEE Conference on Computer Vision and Pattern Recognition (CVPR)*, June 2018.

- Sean Ryan Fanello, Christoph Rhemann, Vladimir Tankovich, Adarsh Kowdle, Sergio Orts Escolano, David Kim, and Shahram Izadi. Hyperdepth: Learning depth from structured light without matching. In *The IEEE Conference on Computer Vision and Pattern Recognition (CVPR)*, June 2016.
- Sean Ryan Fanello, Julien Valentin, Christoph Rhemann, Adarsh Kowdle, Vladimir Tankovich, Philip Davidson, and Shahram Izadi. Ultrastereo: Efficient learning-based matching for active stereo systems. In *The IEEE Conference on Computer Vision and Pattern Recognition (CVPR)*, July 2017.
- Mohammad Sabokrou, Mohammad Khalooei, Mahmood Fathy, and Ehsan Adeli. Adversarially learned one-class classifier for novelty detection. In *The IEEE Conference on Computer Vision and Pattern Recognition (CVPR)*, June 2018.
- Fereshteh Sadeghi, Alexander Toshev, Eric Jang, and Sergey Levine. Sim2real viewpoint invariant visual servoing by recurrent control. In *The IEEE Conference on Computer Vision and Pattern Recognition (CVPR)*, June 2018.
- Amir Sadeghian, Vineet Kosaraju, Ali Sadeghian, Noriaki Hirose, Hamid Rezatofghi, and Silvio Savarese. Sophie: An attentive gan for predicting paths compliant to social and physical constraints. In *The IEEE Conference on Computer Vision and Pattern Recognition (CVPR)*, June 2019.
- Faraz Saeedan, Nicolas Weber, Michael Goesele, and Stefan Roth. Detail-preserving pooling in deep networks. In *The IEEE Conference on Computer Vision and Pattern Recognition (CVPR)*, June 2018.
- Ryusuke Sagawa and Yutaka Satoh. Illuminant-camera communication to observe moving objects under strong external light by spread spectrum modulation. In *The IEEE Conference on Computer Vision and Pattern Recognition (CVPR)*, July 2017.
- Alexander Sage, Eirikur Agustsson, Radu Timofte, and Luc Van Gool. Logo synthesis and manipulation with clustered generative adversarial networks. In *The IEEE Conference on Computer Vision and Pattern Recognition (CVPR)*, June 2018.
- Christos Sagonas, Yannis Panagakis, Alina Leidinger, and Stefanos Zafeiriou. Robust joint and individual variance explained. In *The IEEE Conference on Computer Vision and Pattern Recognition (CVPR)*, July 2017.
- Min-cheol Sagong, Yong-goo Shin, Seung-wook Kim, Seung Park, and Sung-jea Ko. Pepsi : Fast image inpainting with parallel decoding network. In *The IEEE Conference on Computer Vision and Pattern Recognition (CVPR)*, June 2019.
- Kuniaki Saito, Kohei Watanabe, Yoshitaka Ushiku, and Tatsuya Harada. Maximum classifier discrepancy for unsupervised domain adaptation. In *The IEEE Conference on Computer Vision and Pattern Recognition (CVPR)*, June 2018.
- Kuniaki Saito, Yoshitaka Ushiku, Tatsuya Harada, and Kate Saenko. Strong-weak distribution alignment for adaptive object detection. In *The IEEE Conference on Computer Vision and Pattern Recognition (CVPR)*, June 2019.
- Shunsuke Saito, Lingyu Wei, Liwen Hu, Koki Nagano, and Hao Li. Photorealistic facial texture inference using deep neural networks. In *The IEEE Conference on Computer Vision and Pattern Recognition (CVPR)*, July 2017.
- Mehdi S. M. Sajjadi, Raviteja Vemulapalli, and Matthew Brown. Frame-recurrent video super-resolution. In *The IEEE Conference on Computer Vision and Pattern Recognition (CVPR)*, June 2018.
- Naoki Sakakibara, Fumihiko Sakaue, and Jun Sato. Seeing temporal modulation of lights from standard cameras. In *The IEEE Conference on Computer Vision and Pattern Recognition (CVPR)*, June 2018.

- Amaia Salvador, Nicholas Hynes, Yusuf Aytar, Javier Marin, Ferda Ofli, Ingmar Weber, and Antonio Torralba. Learning cross-modal embeddings for cooking recipes and food images. In *The IEEE Conference on Computer Vision and Pattern Recognition (CVPR)*, July 2017.
- Amaia Salvador, Michal Drozdal, Xavier Giro-i Nieto, and Adriana Romero. Inverse cooking: Recipe generation from food images. In *The IEEE Conference on Computer Vision and Pattern Recognition (CVPR)*, June 2019.
- Artsiom Sanakoyeu, Vadim Tschernezki, Uta Buchler, and Bjorn Ommer. Divide and conquer the embedding space for metric learning. In *The IEEE Conference on Computer Vision and Pattern Recognition (CVPR)*, June 2019.
- Luis G. Sanchez Giraldo, Erion Hasanbelliu, Murali Rao, and Jose C. Principe. Group-wise point-set registration based on renyi's second order entropy. In *The IEEE Conference on Computer Vision and Pattern Recognition (CVPR)*, July 2017.
- Tushar Sandhan and Jin Young Choi. Anti-glare: Tightly constrained optimization for eyeglass reflection removal. In *The IEEE Conference on Computer Vision and Pattern Recognition (CVPR)*, July 2017.
- Mark Sandler, Andrew Howard, Menglong Zhu, Andrey Zhmoginov, and Liang-Chieh Chen. Mobilenetv2: Inverted residuals and linear bottlenecks. In *The IEEE Conference on Computer Vision and Pattern Recognition (CVPR)*, June 2018.
- Patsorn Sangkloy, Jingwan Lu, Chen Fang, Fisher Yu, and James Hays. Scribbler: Controlling deep image synthesis with sketch and color. In *The IEEE Conference on Computer Vision and Pattern Recognition (CVPR)*, July 2017.
- Swami Sankaranarayanan, Yogesh Balaji, Arpit Jain, Ser Nam Lim, and Rama Chellappa. Learning from synthetic data: Addressing domain shift for semantic segmentation. In *The IEEE Conference on Computer Vision and Pattern Recognition (CVPR)*, June 2018.
- Rodrigo Santa Cruz, Basura Fernando, Anoop Cherian, and Stephen Gould. Deeppermnet: Visual permutation learning. In *The IEEE Conference on Computer Vision and Pattern Recognition (CVPR)*, July 2017.
- Venkataraman Santhanam, Vlad I. Morariu, and Larry S. Davis. Generalized deep image to image regression. In *The IEEE Conference on Computer Vision and Pattern Recognition (CVPR)*, July 2017.
- Soubhik Sanyal, Timo Bolkart, Haiwen Feng, and Michael J. Black. Learning to regress 3d face shape and expression from an image without 3d supervision. In *The IEEE Conference on Computer Vision and Pattern Recognition (CVPR)*, June 2019.
- M. Saquib Sarfraz, Arne Schumann, Andreas Eberle, and Rainer Stiefelhagen. A pose-sensitive embedding for person re-identification with expanded cross neighborhood re-ranking. In *The IEEE Conference on Computer Vision and Pattern Recognition (CVPR)*, June 2018.
- Saquib Sarfraz, Vivek Sharma, and Rainer Stiefelhagen. Efficient parameter-free clustering using first neighbor relations. In *The IEEE Conference on Computer Vision and Pattern Recognition (CVPR)*, June 2019.
- Mert Bulent Sariyildiz and Ramazan Gokberk Cinbis. Gradient matching generative networks for zero-shot learning. In *The IEEE Conference on Computer Vision and Pattern Recognition (CVPR)*, June 2019.
- Paul-Edouard Sarlin, Cesar Cadena, Roland Siegwart, and Marcin Dymczyk. From coarse to fine: Robust hierarchical localization at large scale. In *The IEEE Conference on Computer Vision and Pattern Recognition (CVPR)*, June 2019.
- Muhammad Sarmad, Hyunjoon Jenny Lee, and Young Min Kim. Rl-gan-net: A reinforcement learning agent controlled gan network for real-time point cloud shape completion. In *The IEEE Conference on Computer Vision and Pattern Recognition (CVPR)*, June 2019.

- Kazuma Sasaki, Satoshi Iizuka, Edgar Simo-Serra, and Hiroshi Ishikawa. Joint gap detection and inpainting of line drawings. In *The IEEE Conference on Computer Vision and Pattern Recognition (CVPR)*, July 2017.
- Torsten Sattler, Michal Havlena, Konrad Schindler, and Marc Pollefeys. Large-scale location recognition and the geometric burstiness problem. In *The IEEE Conference on Computer Vision and Pattern Recognition (CVPR)*, June 2016.
- Torsten Sattler, Akihiko Torii, Josef Sivic, Marc Pollefeys, Hajime Taira, Masatoshi Okutomi, and Tomas Pajdla. Are large-scale 3d models really necessary for accurate visual localization? In *The IEEE Conference on Computer Vision and Pattern Recognition (CVPR)*, July 2017.
- Torsten Sattler, Will Maddern, Carl Toft, Akihiko Torii, Lars Hammarstrand, Erik Stenborg, Daniel Safari, Masatoshi Okutomi, Marc Pollefeys, Josef Sivic, Fredrik Kahl, and Tomas Pajdla. Benchmarking 6dof outdoor visual localization in changing conditions. In *The IEEE Conference on Computer Vision and Pattern Recognition (CVPR)*, June 2018.
- Torsten Sattler, Qunjie Zhou, Marc Pollefeys, and Laura Leal-Taixe. Understanding the limitations of cnn-based absolute camera pose regression. In *The IEEE Conference on Computer Vision and Pattern Recognition (CVPR)*, June 2019.
- Olivier Saurer, Marc Pollefeys, and Gim Hee Lee. Sparse to dense 3d reconstruction from rolling shutter images. In *The IEEE Conference on Computer Vision and Pattern Recognition (CVPR)*, June 2016.
- Nikolay Savinov, Christian Hane, Lubor Ladicky, and Marc Pollefeys. Semantic 3d reconstruction with continuous regularization and ray potentials using a visibility consistency constraint. In *The IEEE Conference on Computer Vision and Pattern Recognition (CVPR)*, June 2016.
- Nikolay Savinov, Akihito Seki, Lubor Ladicky, Torsten Sattler, and Marc Pollefeys. Quad-networks: Unsupervised learning to rank for interest point detection. In *The IEEE Conference on Computer Vision and Pattern Recognition (CVPR)*, July 2017.
- Johann Sawatzky, Abhilash Srikantha, and Juergen Gall. Weakly supervised affordance detection. In *The IEEE Conference on Computer Vision and Pattern Recognition (CVPR)*, July 2017.
- Johann Sawatzky, Yaser Souri, Christian Grund, and Jurgen Gall. What object should i use? - task driven object detection. In *The IEEE Conference on Computer Vision and Pattern Recognition (CVPR)*, June 2019.
- Ian Schillebeeckx and Robert Pless. Single image camera calibration with lenticular arrays for augmented reality. In *The IEEE Conference on Computer Vision and Pattern Recognition (CVPR)*, June 2016.
- Hendrik Schilling, Maximilian Diebold, Carsten Rother, and Bernd Jähne. Trust your model: Light field depth estimation with inline occlusion handling. In *The IEEE Conference on Computer Vision and Pattern Recognition (CVPR)*, June 2018.
- Michael Schober, Amit Adam, Omer Yair, Shai Mazor, and Sebastian Nowozin. Dynamic time-of-flight. In *The IEEE Conference on Computer Vision and Pattern Recognition (CVPR)*, July 2017.
- Johannes L. Schonberger and Jan-Michael Frahm. Structure-from-motion revisited. In *The IEEE Conference on Computer Vision and Pattern Recognition (CVPR)*, June 2016.
- Johannes L. Schonberger, Hans Hardmeier, Torsten Sattler, and Marc Pollefeys. Comparative evaluation of hand-crafted and learned local features. In *The IEEE Conference on Computer Vision and Pattern Recognition (CVPR)*, July 2017.
- Edgar Schonfeld, Sayna Ebrahimi, Samarth Sinha, Trevor Darrell, and Zeynep Akata. Generalized zero- and few-shot learning via aligned variational autoencoders. In *The IEEE Conference on Computer Vision and Pattern Recognition (CVPR)*. June 2019.

- Thomas Schops, Johannes L. Schonberger, Silvano Galliani, Torsten Sattler, Konrad Schindler, Marc Pollefeys, and Andreas Geiger. A multi-view stereo benchmark with high-resolution images and multi-camera videos. In *The IEEE Conference on Computer Vision and Pattern Recognition (CVPR)*, July 2017.
- Thomas Schops, Torsten Sattler, and Marc Pollefeys. Bad slam: Bundle adjusted direct rgb-d slam. In *The IEEE Conference on Computer Vision and Pattern Recognition (CVPR)*, June 2019.
- Samuel Schulter, Paul Vernaza, Wongun Choi, and Manmohan Chandraker. Deep network flow for multi-object tracking. In *The IEEE Conference on Computer Vision and Pattern Recognition (CVPR)*, July 2017.
- Rene Schuster, Oliver Wasenmuller, Christian Unger, and Didier Stricker. Sdc - stacked dilated convolution: A unified descriptor network for dense matching tasks. In *The IEEE Conference on Computer Vision and Pattern Recognition (CVPR)*, June 2019.
- Tal Schuster, Lior Wolf, and David Gadot. Optical flow requires multiple strategies (but only one network). In *The IEEE Conference on Computer Vision and Pattern Recognition (CVPR)*, July 2017.
- Idan Schwartz, Seunghak Yu, Tamir Hazan, and Alexander G. Schwing. Factor graph attention. In *The IEEE Conference on Computer Vision and Pattern Recognition (CVPR)*, June 2019.
- Guillaume Seguin, Piotr Bojanowski, Remi Lajugie, and Ivan Laptev. Instance-level video segmentation from object tracks. In *The IEEE Conference on Computer Vision and Pattern Recognition (CVPR)*, June 2016.
- Akihito Seki and Marc Pollefeys. Sgm-nets: Semi-global matching with neural networks. In *The IEEE Conference on Computer Vision and Pattern Recognition (CVPR)*, July 2017.
- Taiki Sekii. Robust, real-time 3d tracking of multiple objects with similar appearances. In *The IEEE Conference on Computer Vision and Pattern Recognition (CVPR)*, June 2016.
- Yusuke Sekikawa, Kosuke Hara, and Hideo Saito. Eventnet: Asynchronous recursive event processing. In *The IEEE Conference on Computer Vision and Pattern Recognition (CVPR)*, June 2019.
- Fadime Sener and Angela Yao. Unsupervised learning and segmentation of complex activities from video. In *The IEEE Conference on Computer Vision and Pattern Recognition (CVPR)*, June 2018.
- Soumyadip Sengupta, Tal Amir, Meirav Galun, Tom Goldstein, David W. Jacobs, Amit Singer, and Ronen Basri. A new rank constraint on multi-view fundamental matrices, and its application to camera location recovery. In *The IEEE Conference on Computer Vision and Pattern Recognition (CVPR)*, July 2017.
- Soumyadip Sengupta, Angjoo Kanazawa, Carlos D. Castillo, and David W. Jacobs. Sfsnet: Learning shape, reflectance and illuminance of faces ‘in the wild’. In *The IEEE Conference on Computer Vision and Pattern Recognition (CVPR)*, June 2018.
- Arda Senocak, Tae-Hyun Oh, Junsik Kim, Ming-Hsuan Yang, and In So Kweon. Learning to localize sound source in visual scenes. In *The IEEE Conference on Computer Vision and Pattern Recognition (CVPR)*, June 2018.
- Seonguk Seo, Paul Hongsuck Seo, and Bohyung Han. Learning for single-shot confidence calibration in deep neural networks through stochastic inferences. In *The IEEE Conference on Computer Vision and Pattern Recognition (CVPR)*, June 2019.
- Laura Sevilla-Lara, Deqing Sun, Varun Jampani, and Michael J. Black. Optical flow with semantic segmentation and localized layers. In *The IEEE Conference on Computer Vision and Pattern Recognition (CVPR)*, June 2016.
- Meet Shah, Xinlei Chen, Marcus Rohrbach, and Devi Parikh. Cycle-consistency for robust visual question answering. In *The IEEE Conference on Computer Vision and Pattern Recognition (CVPR)*, June 2019.

- Sohil Shah, Tom Goldstein, and Christoph Studer. Estimating sparse signals with smooth support via convex programming and block sparsity. In *The IEEE Conference on Computer Vision and Pattern Recognition (CVPR)*, June 2016.
- Marjan Shahpaski, Luis Ricardo Sapaico, Gaspard Chevassus, and Sabine Susstrunk. Simultaneous geometric and radiometric calibration of a projector-camera pair. In *The IEEE Conference on Computer Vision and Pattern Recognition (CVPR)*, July 2017.
- Amir Shahroudy, Jun Liu, Tian-Tsong Ng, and Gang Wang. Ntu rgb+d: A large scale dataset for 3d human activity analysis. In *The IEEE Conference on Computer Vision and Pattern Recognition (CVPR)*, June 2016.
- Amit Shaked and Lior Wolf. Improved stereo matching with constant highway networks and reflective confidence learning. In *The IEEE Conference on Computer Vision and Pattern Recognition (CVPR)*, July 2017.
- Moein Shakeri and Hong Zhang. Moving object detection under discontinuous change in illumination using tensor low-rank and invariant sparse decomposition. In *The IEEE Conference on Computer Vision and Pattern Recognition (CVPR)*, June 2019.
- Gil Shamai and Ron Kimmel. Geodesic distance descriptors. In *The IEEE Conference on Computer Vision and Pattern Recognition (CVPR)*, July 2017.
- Sukrit Shankar, Duncan Robertson, Yani Ioannou, Antonio Criminisi, and Roberto Cipolla. Refining architectures of deep convolutional neural networks. In *The IEEE Conference on Computer Vision and Pattern Recognition (CVPR)*, June 2016.
- Ishant Shanu, Chetan Arora, and Parag Singla. Min norm point algorithm for higher order mrf-map inference. In *The IEEE Conference on Computer Vision and Pattern Recognition (CVPR)*, June 2016.
- Ishant Shanu, Chetan Arora, and S.N. Maheshwari. Inference in higher order mrf-map problems with small and large cliques. In *The IEEE Conference on Computer Vision and Pattern Recognition (CVPR)*, June 2018.
- Jing Shao, Chen-Change Loy, Kai Kang, and Xiaogang Wang. Slicing convolutional neural network for crowd video understanding. In *The IEEE Conference on Computer Vision and Pattern Recognition (CVPR)*, June 2016.
- Wenqi Shao, Tianjian Meng, Jingyu Li, Ruimao Zhang, Yudian Li, Xiaogang Wang, and Ping Luo. Ssn: Learning sparse switchable normalization via sparsestmax. In *The IEEE Conference on Computer Vision and Pattern Recognition (CVPR)*, June 2019.
- Aidean Sharghi, Jacob S. Laurel, and Boqing Gong. Query-focused video summarization: Dataset, evaluation, and a memory network based approach. In *The IEEE Conference on Computer Vision and Pattern Recognition (CVPR)*, July 2017.
- Vivek Sharma, Ali Diba, Davy Neven, Michael S. Brown, Luc Van Gool, and Rainer Stiefelhagen. Classification-driven dynamic image enhancement. In *The IEEE Conference on Computer Vision and Pattern Recognition (CVPR)*, June 2018.
- Viktoriaa Sharmanska, Daniel Hernandez-Lobato, Jose Miguel Hernandez-Lobato, and Novi Quadrianto. Ambiguity helps: Classification with disagreements in crowdsourced annotations. In *The IEEE Conference on Computer Vision and Pattern Recognition (CVPR)*, June 2016.
- Mark Sheinin and Yoav Y. Schechner. The next best underwater view. In *The IEEE Conference on Computer Vision and Pattern Recognition (CVPR)*, June 2016.
- Mark Sheinin, Yoav Y. Schechner, and Kiriakos N. Kutulakos. Computational imaging on the electric grid. In *The IEEE Conference on Computer Vision and Pattern Recognition (CVPR)*, July 2017.

- Hao Shen. Towards a mathematical understanding of the difficulty in learning with feedforward neural networks. In *The IEEE Conference on Computer Vision and Pattern Recognition (CVPR)*, June 2018.
- Wei Shen, Kai Zhao, Yuan Jiang, Yan Wang, Zhijiang Zhang, and Xiang Bai. Object skeleton extraction in natural images by fusing scale-associated deep side outputs. In *The IEEE Conference on Computer Vision and Pattern Recognition (CVPR)*, June 2016.
- Yunhang Shen, Rongrong Ji, Yan Wang, Yongjian Wu, and Liujuan Cao. Cyclic guidance for weakly supervised joint detection and segmentation. In *The IEEE Conference on Computer Vision and Pattern Recognition (CVPR)*, June 2019.
- Zhiqiang Shen, Jianguo Li, Zhou Su, Minjun Li, Yurong Chen, Yu-Gang Jiang, and Xiangyang Xue. Weakly supervised dense video captioning. In *The IEEE Conference on Computer Vision and Pattern Recognition (CVPR)*, July 2017.
- Lu Sheng, Jianfei Cai, Tat-Jen Cham, Vladimir Pavlovic, and King Ngi Ngan. A generative model for depth-based robust 3d facial pose tracking. In *The IEEE Conference on Computer Vision and Pattern Recognition (CVPR)*, July 2017.
- Lu Sheng, Ziyi Lin, Jing Shao, and Xiaogang Wang. Avatar-net: Multi-scale zero-shot style transfer by feature decoration. In *The IEEE Conference on Computer Vision and Pattern Recognition (CVPR)*, June 2018.
- Rakshith Shetty, Bernt Schiele, and Mario Fritz. Not using the car to see the sidewalk – quantifying and controlling the effects of context in classification and segmentation. In *The IEEE Conference on Computer Vision and Pattern Recognition (CVPR)*, June 2019.
- Irina Shevlev and Shai Avidan. Co-occurrence neural network. In *The IEEE Conference on Computer Vision and Pattern Recognition (CVPR)*, June 2019.
- Jian Shi, Yue Dong, Hao Su, and Stella X. Yu. Learning non-lambertian object intrinsics across shapenet categories. In *The IEEE Conference on Computer Vision and Pattern Recognition (CVPR)*, July 2017.
- Shaoshuai Shi, Xiaogang Wang, and Hongsheng Li. Pointcnn: 3d object proposal generation and detection from point cloud. In *The IEEE Conference on Computer Vision and Pattern Recognition (CVPR)*, June 2019.
- Wenzhe Shi, Jose Caballero, Ferenc Huszar, Johannes Totz, Andrew P. Aitken, Rob Bishop, Daniel Rueckert, and Zehan Wang. Real-time single image and video super-resolution using an efficient sub-pixel convolutional neural network. In *The IEEE Conference on Computer Vision and Pattern Recognition (CVPR)*, June 2016.
- Xuepeng Shi, Shiguang Shan, Meina Kan, Shuzhe Wu, and Xilin Chen. Real-time rotation-invariant face detection with progressive calibration networks. In *The IEEE Conference on Computer Vision and Pattern Recognition (CVPR)*, June 2018.
- Takashi Shibata, Masayuki Tanaka, and Masatoshi Okutomi. Gradient-domain image reconstruction framework with intensity-range and base-structure constraints. In *The IEEE Conference on Computer Vision and Pattern Recognition (CVPR)*, June 2016.
- Kevin J. Shih, Saurabh Singh, and Derek Hoiem. Where to look: Focus regions for visual question answering. In *The IEEE Conference on Computer Vision and Pattern Recognition (CVPR)*, June 2016.
- Ya-Fang Shih, Yang-Ming Yeh, Yen-Yu Lin, Ming-Fang Weng, Yi-Chang Lu, and Yung-Yu Chuang. Deep co-occurrence feature learning for visual object recognition. In *The IEEE Conference on Computer Vision and Pattern Recognition (CVPR)*, July 2017.
- Mihoko Shimano, Hiroki Okawa, Yuta Asano, Ryoma Bise, Ko Nishino, and Imari Sato. Wetness and color from a single multispectral image. In *The IEEE Conference on Computer Vision and Pattern Recognition (CVPR)*, July 2017.

- Daeyun Shin, Charless C. Fowlkes, and Derek Hoiem. Pixels, voxels, and views: A study of shape representations for single view 3d object shape prediction. In *The IEEE Conference on Computer Vision and Pattern Recognition (CVPR)*, June 2018.
- Hoo-Chang Shin, Kirk Roberts, Le Lu, Dina Demner-Fushman, Jianhua Yao, and Ronald M. Summers. Learning to read chest x-rays: Recurrent neural cascade model for automated image annotation. In *The IEEE Conference on Computer Vision and Pattern Recognition (CVPR)*, June 2016.
- Jae Shin Yoon, Ziwei Li, and Hyun Soo Park. 3d semantic trajectory reconstruction from 3d pixel continuum. In *The IEEE Conference on Computer Vision and Pattern Recognition (CVPR)*, June 2018.
- Eli Shlizerman, Lucio Dery, Hayden Schoen, and Ira Kemelmacher-Shlizerman. Audio to body dynamics. In *The IEEE Conference on Computer Vision and Pattern Recognition (CVPR)*, June 2018.
- Assaf Shocher, Nadav Cohen, and Michal Irani. “zero-shot” super-resolution using deep internal learning. In *The IEEE Conference on Computer Vision and Pattern Recognition (CVPR)*, June 2018.
- Zheng Shou, Dongang Wang, and Shih-Fu Chang. Temporal action localization in untrimmed videos via multi-stage cnns. In *The IEEE Conference on Computer Vision and Pattern Recognition (CVPR)*, June 2016.
- Zheng Shou, Jonathan Chan, Alireza Zareian, Kazuyuki Miyazawa, and Shih-Fu Chang. Cdc: Convolutional-de-convolutional networks for precise temporal action localization in untrimmed videos. In *The IEEE Conference on Computer Vision and Pattern Recognition (CVPR)*, July 2017.
- Zheng Shou, Xudong Lin, Yannis Kalantidis, Laura Sevilla-Lara, Marcus Rohrbach, Shih-Fu Chang, and Zhicheng Yan. Dmc-net: Generating discriminative motion cues for fast compressed video action recognition. In *The IEEE Conference on Computer Vision and Pattern Recognition (CVPR)*, June 2019.
- Robik Shrestha, Kushal Kafle, and Christopher Kanan. Answer them all! toward universal visual question answering models. In *The IEEE Conference on Computer Vision and Pattern Recognition (CVPR)*, June 2019.
- Abhinav Shrivastava, Abhinav Gupta, and Ross Girshick. Training region-based object detectors with online hard example mining. In *The IEEE Conference on Computer Vision and Pattern Recognition (CVPR)*, June 2016.
- Ashish Shrivastava, Tomas Pfister, Oncel Tuzel, Joshua Susskind, Wenda Wang, and Russell Webb. Learning from simulated and unsupervised images through adversarial training. In *The IEEE Conference on Computer Vision and Pattern Recognition (CVPR)*, July 2017.
- Tianmin Shu, Sinisa Todorovic, and Song-Chun Zhu. Cern: Confidence-energy recurrent network for group activity recognition. In *The IEEE Conference on Computer Vision and Pattern Recognition (CVPR)*, July 2017.
- Bing Shuai, Zhen Zuo, Bing Wang, and Gang Wang. Dag-recurrent neural networks for scene labeling. In *The IEEE Conference on Computer Vision and Pattern Recognition (CVPR)*, June 2016.
- Maria Shugrina, Ziheng Liang, Amlan Kar, Jiaman Li, Angad Singh, Karan Singh, and Sanja Fidler. Creative flow+ dataset. In *The IEEE Conference on Computer Vision and Pattern Recognition (CVPR)*, June 2019.
- Kurt Shuster, Samuel Humeau, Hexiang Hu, Antoine Bordes, and Jason Weston. Engaging image captioning via personality. In *The IEEE Conference on Computer Vision and Pattern Recognition (CVPR)*, June 2019.

- Aliaksandra Shysheya, Egor Zakharov, Kara-Ali Aliev, Renat Bashirov, Egor Burkov, Karim Iskakov, Aleksei Ivakhnenko, Yury Malkov, Igor Pasechnik, Dmitry Ulyanov, Alexander Vakhtov, and Victor Lempitsky. Textured neural avatars. In *The IEEE Conference on Computer Vision and Pattern Recognition (CVPR)*, June 2019.
- Chenyang Si, Wei Wang, Liang Wang, and Tieniu Tan. Multistage adversarial losses for pose-based human image synthesis. In *The IEEE Conference on Computer Vision and Pattern Recognition (CVPR)*, June 2018.
- Chenyang Si, Wentao Chen, Wei Wang, Liang Wang, and Tieniu Tan. An attention enhanced graph convolutional lstm network for skeleton-based action recognition. In *The IEEE Conference on Computer Vision and Pattern Recognition (CVPR)*, June 2019.
- Aliaksandr Siarohin, Enver Sangineto, Stéphane Lathuilière, and Nicu Sebe. Deformable gans for pose-based human image generation. In *The IEEE Conference on Computer Vision and Pattern Recognition (CVPR)*, June 2018.
- Aliaksandr Siarohin, Stephane Lathuiliere, Sergey Tulyakov, Elisa Ricci, and Nicu Sebe. Animating arbitrary objects via deep motion transfer. In *The IEEE Conference on Computer Vision and Pattern Recognition (CVPR)*, June 2019.
- Ronan Sifre, Yannis Avrithis, Ewa Kijak, and Frederic Jurie. Unsupervised part learning for visual recognition. In *The IEEE Conference on Computer Vision and Pattern Recognition (CVPR)*, July 2017.
- Gunnar A. Sigurdsson, Santosh Divvala, Ali Farhadi, and Abhinav Gupta. Asynchronous temporal fields for action recognition. In *The IEEE Conference on Computer Vision and Pattern Recognition (CVPR)*, July 2017.
- Gunnar A. Sigurdsson, Abhinav Gupta, Cordelia Schmid, Ali Farhadi, and Karteek Alahari. Actor and observer: Joint modeling of first and third-person videos. In *The IEEE Conference on Computer Vision and Pattern Recognition (CVPR)*, June 2018.
- Karan Sikka, Gaurav Sharma, and Marian Bartlett. Lomo: Latent ordinal model for facial analysis in videos. In *The IEEE Conference on Computer Vision and Pattern Recognition (CVPR)*, June 2016.
- Michel Silva, Washington Ramos, João Ferreira, Felipe Chamone, Mario Campos, and Erickson R. Nascimento. A weighted sparse sampling and smoothing frame transition approach for semantic fast-forward first-person videos. In *The IEEE Conference on Computer Vision and Pattern Recognition (CVPR)*, June 2018.
- Thiago L. T. da Silveira and Claudio R. Jung. Perturbation analysis of the 8-point algorithm: A case study for wide fov cameras. In *The IEEE Conference on Computer Vision and Pattern Recognition (CVPR)*, June 2019.
- Oriane Simeoni, Yannis Avrithis, and Ondrej Chum. Local features and visual words emerge in activations. In *The IEEE Conference on Computer Vision and Pattern Recognition (CVPR)*, June 2019.
- Edgar Simo-Serra and Hiroshi Ishikawa. Fashion style in 128 floats: Joint ranking and classification using weak data for feature extraction. In *The IEEE Conference on Computer Vision and Pattern Recognition (CVPR)*, June 2016.
- Tomas Simon, Hanbyul Joo, Iain Matthews, and Yaser Sheikh. Hand keypoint detection in single images using multiview bootstrapping. In *The IEEE Conference on Computer Vision and Pattern Recognition (CVPR)*, July 2017.
- Martin Simonovsky and Nikos Komodakis. Dynamic edge-conditioned filters in convolutional neural networks on graphs. In *The IEEE Conference on Computer Vision and Pattern Recognition (CVPR)*, July 2017.

- Bharat Singh, Hengduo Li, Abhishek Sharma, and Larry S. Davis. R-fcn-3000 at 30fps: Decoupling detection and classification. In *The IEEE Conference on Computer Vision and Pattern Recognition (CVPR)*, June 2018.
- Pravendra Singh, Vinay Kumar Verma, Piyush Rai, and Vinay P. Namboodiri. Hetconv: Heterogeneous kernel-based convolutions for deep cnns. In *The IEEE Conference on Computer Vision and Pattern Recognition (CVPR)*, June 2019.
- Saurabh Singh, Derek Hoiem, and David Forsyth. Learning to localize little landmarks. In *The IEEE Conference on Computer Vision and Pattern Recognition (CVPR)*, June 2016.
- Ayan Sinha, Chiho Choi, and Karthik Ramani. Deephand: Robust hand pose estimation by completing a matrix imputed with deep features. In *The IEEE Conference on Computer Vision and Pattern Recognition (CVPR)*, June 2016.
- Ayan Sinha, Asim Unmesh, Qixing Huang, and Karthik Ramani. Surfnet: Generating 3d shape surfaces using deep residual networks. In *The IEEE Conference on Computer Vision and Pattern Recognition (CVPR)*, July 2017.
- Amos Sironi, Manuele Brambilla, Nicolas Bourdis, Xavier Lagorce, and Ryad Benosman. Hats: Histograms of averaged time surfaces for robust event-based object classification. In *The IEEE Conference on Computer Vision and Pattern Recognition (CVPR)*, June 2018.
- Vincent Sitzmann, Justus Thies, Felix Heide, Matthias Niessner, Gordon Wetzstein, and Michael Zollhofer. Deepvoxels: Learning persistent 3d feature embeddings. In *The IEEE Conference on Computer Vision and Pattern Recognition (CVPR)*, June 2019.
- Nicki Skaftø Detlefsen, Oren Freifeld, and Søren Hauberg. Deep diffeomorphic transformer networks. In *The IEEE Conference on Computer Vision and Pattern Recognition (CVPR)*, June 2018.
- Miroslava Slavcheva, Maximilian Baust, Daniel Cremers, and Slobodan Ilic. Killingfusion: Non-rigid 3d reconstruction without correspondences. In *The IEEE Conference on Computer Vision and Pattern Recognition (CVPR)*, July 2017.
- Miroslava Slavcheva, Maximilian Baust, and Slobodan Ilic. Sobolevfusion: 3d reconstruction of scenes undergoing free non-rigid motion. In *The IEEE Conference on Computer Vision and Pattern Recognition (CVPR)*, June 2018.
- Brandon M. Smith, Matthew O’Toole, and Mohit Gupta. Tracking multiple objects outside the line of sight using speckle imaging. In *The IEEE Conference on Computer Vision and Pattern Recognition (CVPR)*, June 2018.
- Leslie N. Smith, Emily M. Hand, and Timothy Doster. Gradual dropin of layers to train very deep neural networks. In *The IEEE Conference on Computer Vision and Pattern Recognition (CVPR)*, June 2016.
- Jakub Sochor, Adam Herout, and Jiri Havel. Boxcars: 3d boxes as cnn input for improved fine-grained vehicle recognition. In *The IEEE Conference on Computer Vision and Pattern Recognition (CVPR)*, June 2016.
- Jae Woong Soh, Gu Yong Park, Junho Jo, and Nam Ik Cho. Natural and realistic single image super-resolution with explicit natural manifold discrimination. In *The IEEE Conference on Computer Vision and Pattern Recognition (CVPR)*, June 2019.
- Jeany Son, Mooyeol Baek, Minsu Cho, and Bohyung Han. Multi-object tracking with quadruplet convolutional neural networks. In *The IEEE Conference on Computer Vision and Pattern Recognition (CVPR)*, July 2017.
- Kilho Son, daniel Moreno, James Hays, and David B. Cooper. Solving small-piece jigsaw puzzles by growing consensus. In *The IEEE Conference on Computer Vision and Pattern Recognition (CVPR)*, June 2016.

- Joon Son Chung, Andrew Senior, Oriol Vinyals, and Andrew Zisserman. Lip reading sentences in the wild. In *The IEEE Conference on Computer Vision and Pattern Recognition (CVPR)*, July 2017.
- Jifei Song, Kaiyue Pang, Yi-Zhe Song, Tao Xiang, and Timothy M. Hospedales. Learning to sketch with shortcut cycle consistency. In *The IEEE Conference on Computer Vision and Pattern Recognition (CVPR)*, June 2018.
- Jifei Song, Yongxin Yang, Yi-Zhe Song, Tao Xiang, and Timothy M. Hospedales. Generalizable person re-identification by domain-invariant mapping network. In *The IEEE Conference on Computer Vision and Pattern Recognition (CVPR)*, June 2019.
- Shuran Song and Jianxiong Xiao. Deep sliding shapes for amodal 3d object detection in rgb-d images. In *The IEEE Conference on Computer Vision and Pattern Recognition (CVPR)*, June 2016.
- Shuran Song, Fisher Yu, Andy Zeng, Angel X. Chang, Manolis Savva, and Thomas Funkhouser. Semantic scene completion from a single depth image. In *The IEEE Conference on Computer Vision and Pattern Recognition (CVPR)*, July 2017.
- Khurram Soomro, Haroon Idrees, and Mubarak Shah. Predicting the where and what of actors and actions through online action localization. In *The IEEE Conference on Computer Vision and Pattern Recognition (CVPR)*, June 2016.
- Nasim Souly and Mubarak Shah. Scene labeling using sparse precision matrix. In *The IEEE Conference on Computer Vision and Pattern Recognition (CVPR)*, June 2016.
- Concetto Spampinato, Simone Palazzo, Isaak Kavasidis, Daniela Giordano, Nasim Souly, and Mubarak Shah. Deep learning human mind for automated visual classification. In *The IEEE Conference on Computer Vision and Pattern Recognition (CVPR)*, July 2017.
- Pablo Speciale, Danda Pani Paudel, Martin R. Oswald, Till Kroeger, Luc Van Gool, and Marc Pollefeys. Consensus maximization with linear matrix inequality constraints. In *The IEEE Conference on Computer Vision and Pattern Recognition (CVPR)*, July 2017.
- Pablo Speciale, Danda P. Paudel, Martin R. Oswald, Hayko Riemenschneider, Luc Van Gool, and Marc Pollefeys. Consensus maximization for semantic region correspondences. In *The IEEE Conference on Computer Vision and Pattern Recognition (CVPR)*, June 2018.
- Pablo Speciale, Johannes L. Schonberger, Sing Bing Kang, Sudipta N. Sinha, and Marc Pollefeys. Privacy preserving image-based localization. In *The IEEE Conference on Computer Vision and Pattern Recognition (CVPR)*, June 2019.
- Jaime Spencer, Richard Bowden, and Simon Hadfield. Scale-adaptive neural dense features: Learning via hierarchical context aggregation. In *The IEEE Conference on Computer Vision and Pattern Recognition (CVPR)*, June 2019.
- Adrian Spurr, Jie Song, Seonwook Park, and Otmar Hilliges. Cross-modal deep variational hand pose estimation. In *The IEEE Conference on Computer Vision and Pattern Recognition (CVPR)*, June 2018.
- Pratul P. Srinivasan, Ren Ng, and Ravi Ramamoorthi. Light field blind motion deblurring. In *The IEEE Conference on Computer Vision and Pattern Recognition (CVPR)*, July 2017.
- Pratul P. Srinivasan, Rahul Garg, Neal Wadhwa, Ren Ng, and Jonathan T. Barron. Aperture supervision for monocular depth estimation. In *The IEEE Conference on Computer Vision and Pattern Recognition (CVPR)*, June 2018.
- Pratul P. Srinivasan, Richard Tucker, Jonathan T. Barron, Ravi Ramamoorthi, Ren Ng, and Noah Snavely. Pushing the boundaries of view extrapolation with multiplane images. In *The IEEE Conference on Computer Vision and Pattern Recognition (CVPR)*, June 2019.

- Russell Stewart, Mykhaylo Andriluka, and Andrew Y. Ng. End-to-end people detection in crowded scenes. In *The IEEE Conference on Computer Vision and Pattern Recognition (CVPR)*, June 2016.
- Timo Stoffregen and Lindsay Kleeman. Event cameras, contrast maximization and reward functions: An analysis. In *The IEEE Conference on Computer Vision and Pattern Recognition (CVPR)*, June 2019.
- Stefan Stojanov, Samarth Mishra, Ngoc Anh Thai, Nikhil Dhanda, Ahmad Humayun, Chen Yu, Linda B. Smith, and James M. Rehg. Incremental object learning from contiguous views. In *The IEEE Conference on Computer Vision and Pattern Recognition (CVPR)*, June 2019.
- Austin Stone, Huayan Wang, Michael Stark, Yi Liu, D. Scott Phoenix, and Dileep George. Teaching compositionality to cnns. In *The IEEE Conference on Computer Vision and Pattern Recognition (CVPR)*, July 2017.
- Julian Straub, Trevor Campbell, Jonathan P. How, and John W. Fisher, III. Efficient global point cloud alignment using bayesian nonparametric mixtures. In *The IEEE Conference on Computer Vision and Pattern Recognition (CVPR)*, July 2017.
- Michael Strecke, Anna Alperovich, and Bastian Goldluecke. Accurate depth and normal maps from occlusion-aware focal stack symmetry. In *The IEEE Conference on Computer Vision and Pattern Recognition (CVPR)*, July 2017.
- Elena Stumm, Christopher Mei, Simon Lacroix, Juan Nieto, Marco Hutter, and Roland Siegwart. Robust visual place recognition with graph kernels. In *The IEEE Conference on Computer Vision and Pattern Recognition (CVPR)*, June 2016.
- David Stutz and Andreas Geiger. Learning 3d shape completion from laser scan data with weak supervision. In *The IEEE Conference on Computer Vision and Pattern Recognition (CVPR)*, June 2018.
- David Stutz, Matthias Hein, and Bernt Schiele. Disentangling adversarial robustness and generalization. In *The IEEE Conference on Computer Vision and Pattern Recognition (CVPR)*, June 2019.
- Bing Su and Gang Hua. Order-preserving wasserstein distance for sequence matching. In *The IEEE Conference on Computer Vision and Pattern Recognition (CVPR)*, July 2017.
- Hang Su, Varun Jampani, Deqing Sun, Subhransu Maji, Evangelos Kalogerakis, Ming-Hsuan Yang, and Jan Kautz. Splatnet: Sparse lattice networks for point cloud processing. In *The IEEE Conference on Computer Vision and Pattern Recognition (CVPR)*, June 2018.
- Kai Su, Dongdong Yu, Zhenqi Xu, Xin Geng, and Changhu Wang. Multi-person pose estimation with enhanced channel-wise and spatial information. In *The IEEE Conference on Computer Vision and Pattern Recognition (CVPR)*, June 2019.
- Shuochen Su, Felix Heide, Robin Swanson, Jonathan Klein, Clara Callenberg, Matthias Hullin, and Wolfgang Heidrich. Material classification using raw time-of-flight measurements. In *The IEEE Conference on Computer Vision and Pattern Recognition (CVPR)*, June 2016.
- Swathikiran Sudhakaran, Sergio Escalera, and Oswald Lanz. Lsta: Long short-term attention for egocentric action recognition. In *The IEEE Conference on Computer Vision and Pattern Recognition (CVPR)*, June 2019.
- Masanori Suganuma, Xing Liu, and Takayuki Okatani. Attention-based adaptive selection of operations for image restoration in the presence of unknown combined distortions. In *The IEEE Conference on Computer Vision and Pattern Recognition (CVPR)*, June 2019.
- Yumin Suh, Bohyung Han, Wonsik Kim, and Kyoung Mu Lee. Stochastic class-based hard example mining for deep metric learning. In *The IEEE Conference on Computer Vision and Pattern Recognition (CVPR)*, June 2019.

- Waqas Sultani and Mubarak Shah. What if we do not have multiple videos of the same action? – video action localization using web images. In *The IEEE Conference on Computer Vision and Pattern Recognition (CVPR)*, June 2016.
- Waqas Sultani, Chen Chen, and Mubarak Shah. Real-world anomaly detection in surveillance videos. In *The IEEE Conference on Computer Vision and Pattern Recognition (CVPR)*, June 2018.
- Chen Sun, Manohar Paluri, Ronan Collobert, Ram Nevatia, and Lubomir Bourdev. Pronet: Learning to propose object-specific boxes for cascaded neural networks. In *The IEEE Conference on Computer Vision and Pattern Recognition (CVPR)*, June 2016.
- Chen Sun, Abhinav Shrivastava, Carl Vondrick, Rahul Sukthankar, Kevin Murphy, and Cordelia Schmid. Relational action forecasting. In *The IEEE Conference on Computer Vision and Pattern Recognition (CVPR)*, June 2019.
- Haoliang Sun, Xiantong Zhen, Yuanjie Zheng, Gongping Yang, Yilong Yin, and Shuo Li. Learning deep match kernels for image-set classification. In *The IEEE Conference on Computer Vision and Pattern Recognition (CVPR)*, July 2017.
- Qilin Sun, Xiong Dun, Yifan Peng, and Wolfgang Heidrich. Depth and transient imaging with compressive spad array cameras. In *The IEEE Conference on Computer Vision and Pattern Recognition (CVPR)*, June 2018.
- Flood Sung, Yongxin Yang, Li Zhang, Tao Xiang, Philip H.S. Torr, and Timothy M. Hospedales. Learning to compare: Relation network for few-shot learning. In *The IEEE Conference on Computer Vision and Pattern Recognition (CVPR)*, June 2018.
- Jaehung Surh, Hae-Gon Jeon, Yunwon Park, Sunghoon Im, Hyowon Ha, and In So Kweon. Noise robust depth from focus using a ring difference filter. In *The IEEE Conference on Computer Vision and Pattern Recognition (CVPR)*, July 2017.
- Didac Suris, Adria Recasens, David Bau, David Harwath, James Glass, and Antonio Torralba. Learning words by drawing images. In *The IEEE Conference on Computer Vision and Pattern Recognition (CVPR)*, June 2019.
- Tomoyuki Suzuki, Hirokatsu Kataoka, Yoshimitsu Aoki, and Yutaka Satoh. Anticipating traffic accidents with adaptive loss and large-scale incident db. In *The IEEE Conference on Computer Vision and Pattern Recognition (CVPR)*, June 2018.
- Paul Swoboda and Vladimir Kolmogorov. Map inference via block-coordinate frank-wolfe algorithm. In *The IEEE Conference on Computer Vision and Pattern Recognition (CVPR)*, June 2019.
- Paul Swoboda, Jan Kuske, and Bogdan Savchynskyy. A dual ascent framework for lagrangean decomposition of combinatorial problems. In *The IEEE Conference on Computer Vision and Pattern Recognition (CVPR)*, July 2017.
- Christian Szegedy, Vincent Vanhoucke, Sergey Ioffe, Jon Shlens, and Zbigniew Wojna. Rethinking the inception architecture for computer vision. In *The IEEE Conference on Computer Vision and Pattern Recognition (CVPR)*, June 2016.
- Mario Sznajder and Octavia Camps. Sos-rsc: A sum-of-squares polynomial approach to robustifying subspace clustering algorithms. In *The IEEE Conference on Computer Vision and Pattern Recognition (CVPR)*, June 2018.
- Domen Tabernik, Matej Kristan, and Aleš Leonardis. Spatially-adaptive filter units for deep neural networks. In *The IEEE Conference on Computer Vision and Pattern Recognition (CVPR)*, June 2018.
- Saeid Asgari Taghanaki, Kumar Abhishek, Shekoofeh Azizi, and Ghassan Hamarneh. A kernelized manifold mapping to diminish the effect of adversarial perturbations. In *The IEEE Conference on Computer Vision and Pattern Recognition (CVPR)*. June 2019.

- Ying Tai, Jian Yang, and Xiaoming Liu. Image super-resolution via deep recursive residual network. In *The IEEE Conference on Computer Vision and Pattern Recognition (CVPR)*, July 2017.
- Hajime Taira, Masatoshi Okutomi, Torsten Sattler, Mircea Cimpoi, Marc Pollefeys, Josef Sivic, Tomas Pajdla, and Akihiko Torii. Inloc: Indoor visual localization with dense matching and view synthesis. In *The IEEE Conference on Computer Vision and Pattern Recognition (CVPR)*, June 2018.
- Kosuke Takahashi, Akihiro Miyata, Shohei Nobuhara, and Takashi Matsuyama. A linear extrinsic calibration of kaleidoscopic imaging system from single 3d point. In *The IEEE Conference on Computer Vision and Pattern Recognition (CVPR)*, July 2017.
- Tsuyoshi Takatani, Takahito Aoto, and Yasuhiro Mukaigawa. One-shot hyperspectral imaging using faced reflectors. In *The IEEE Conference on Computer Vision and Pattern Recognition (CVPR)*, July 2017.
- Shoichiro Takeda, Kazuki Okami, Dan Mikami, Megumi Isogai, and Hideaki Kimata. Jerk-aware video acceleration magnification. In *The IEEE Conference on Computer Vision and Pattern Recognition (CVPR)*, June 2018.
- Shoichiro Takeda, Yasunori Akagi, Kazuki Okami, Megumi Isogai, and Hideaki Kimata. Video magnification in the wild using fractional anisotropy in temporal distribution. In *The IEEE Conference on Computer Vision and Pattern Recognition (CVPR)*, June 2019.
- Lior Talker, Yael Moses, and Ilan Shimshoni. Using spatial order to boost the elimination of incorrect feature matches. In *The IEEE Conference on Computer Vision and Pattern Recognition (CVPR)*, June 2016.
- Itamar Talmi, Roey Mechrez, and Lihi Zelnik-Manor. Template matching with deformable diversity similarity. In *The IEEE Conference on Computer Vision and Pattern Recognition (CVPR)*, July 2017.
- Youssef Tamaazousti, Herve Le Borgne, and Celine Hudelot. Mucal-net: Multi categorical-level networks to generate more discriminating features. In *The IEEE Conference on Computer Vision and Pattern Recognition (CVPR)*, July 2017.
- Mingxing Tan, Bo Chen, Ruoming Pang, Vijay Vasudevan, Mark Sandler, Andrew Howard, and Quoc V. Le. Mnasnet: Platform-aware neural architecture search for mobile. In *The IEEE Conference on Computer Vision and Pattern Recognition (CVPR)*, June 2019.
- Weimin Tan, Bo Yan, and Bahetiyaer Bare. Feature super-resolution: Make machine see more clearly. In *The IEEE Conference on Computer Vision and Pattern Recognition (CVPR)*, June 2018.
- Kenichiro Tanaka, Yasuhiro Mukaigawa, Hiroyuki Kubo, Yasuyuki Matsushita, and Yasushi Yagi. Recovering transparent shape from time-of-flight distortion. In *The IEEE Conference on Computer Vision and Pattern Recognition (CVPR)*, June 2016.
- Kenichiro Tanaka, Yasuhiro Mukaigawa, Takuya Funatomi, Hiroyuki Kubo, Yasuyuki Matsushita, and Yasushi Yagi. Material classification using frequency- and depth-dependent time-of-flight distortion. In *The IEEE Conference on Computer Vision and Pattern Recognition (CVPR)*, July 2017.
- Kenichiro Tanaka, Nobuhiro Ikeya, Tsuyoshi Takatani, Hiroyuki Kubo, Takuya Funatomi, and Yasuhiro Mukaigawa. Time-resolved light transport decomposition for thermal photometric stereo. In *The IEEE Conference on Computer Vision and Pattern Recognition (CVPR)*, June 2018.
- Huixuan Tang, Scott Cohen, Brian Price, Stephen Schiller, and Kiriakos N. Kutulakos. Depth from defocus in the wild. In *The IEEE Conference on Computer Vision and Pattern Recognition (CVPR)*, July 2017.
- Meng Tang, Abdelaziz Djelouah, Federico Perazzi, Yuri Boykov, and Christopher Schroers. Normalized cut loss for weakly-supervised cnn segmentation. In *The IEEE Conference on Computer Vision and Pattern Recognition (CVPR)*, June 2018.

- Wei Tang and Ying Wu. Does learning specific features for related parts help human pose estimation? In *The IEEE Conference on Computer Vision and Pattern Recognition (CVPR)*, June 2019.
- Yuxing Tang, Josiah Wang, Boyang Gao, Emmanuel Dellandrea, Robert Gaizauskas, and Liming Chen. Large scale semi-supervised object detection using visual and semantic knowledge transfer. In *The IEEE Conference on Computer Vision and Pattern Recognition (CVPR)*, June 2016.
- Tatsunori Tanaii, Sudipta N. Sinha, and Yoichi Sato. Joint recovery of dense correspondence and cosegmentation in two images. In *The IEEE Conference on Computer Vision and Pattern Recognition (CVPR)*, June 2016.
- Tatsunori Tanaii, Sudipta N. Sinha, and Yoichi Sato. Fast multi-frame stereo scene flow with motion segmentation. In *The IEEE Conference on Computer Vision and Pattern Recognition (CVPR)*, July 2017.
- Ryutaro Tanno, Ardavan Saedi, Swami Sankaranarayanan, Daniel C. Alexander, and Nathan Silberman. Learning from noisy labels by regularized estimation of annotator confusion. In *The IEEE Conference on Computer Vision and Pattern Recognition (CVPR)*, June 2019.
- Ran Tao, Efstratios Gavves, and Arnold W.M. Smeulders. Siamese instance search for tracking. In *The IEEE Conference on Computer Vision and Pattern Recognition (CVPR)*, June 2016.
- Xin Tao, Hongyun Gao, Xiaoyong Shen, Jue Wang, and Jiaya Jia. Scale-recurrent network for deep image deblurring. In *The IEEE Conference on Computer Vision and Pattern Recognition (CVPR)*, June 2018.
- Makarand Tapaswi, Yukun Zhu, Rainer Stiefelhausen, Antonio Torralba, Raquel Urtasun, and Sanja Fidler. Movieqa: Understanding stories in movies through question-answering. In *The IEEE Conference on Computer Vision and Pattern Recognition (CVPR)*, June 2016.
- Olga Taran, Shideh Rezaeifar, Taras Holotyak, and Slava Voloshynovskiy. Defending against adversarial attacks by randomized diversification. In *The IEEE Conference on Computer Vision and Pattern Recognition (CVPR)*, June 2019.
- Maxim Tatarchenko, Jaesik Park, Vladlen Koltun, and Qian-Yi Zhou. Tangent convolutions for dense prediction in 3d. In *The IEEE Conference on Computer Vision and Pattern Recognition (CVPR)*, June 2018.
- Maxim Tatarchenko, Stephan R. Richter, Rene Ranftl, Zhuwen Li, Vladlen Koltun, and Thomas Brox. What do single-view 3d reconstruction networks learn? In *The IEEE Conference on Computer Vision and Pattern Recognition (CVPR)*, June 2019.
- Keisuke Tateno, Federico Tombari, Iro Laina, and Nassir Navab. Cnn-slam: Real-time dense monocular slam with learned depth prediction. In *The IEEE Conference on Computer Vision and Pattern Recognition (CVPR)*, July 2017.
- Hamed R. Tavakoli, Fawad Ahmed, Ali Borji, and Jorma Laaksonen. Saliency revisited: Analysis of mouse movements versus fixations. In *The IEEE Conference on Computer Vision and Pattern Recognition (CVPR)*, July 2017.
- Chiat-Pin Tay, Sharmili Roy, and Kim-Hui Yap. Aanet: Attribute attention network for person re-identifications. In *The IEEE Conference on Computer Vision and Pattern Recognition (CVPR)*, June 2019.
- Lyne P. Tchapmi, Vineet Kosaraju, Hamid Rezaatofighi, Ian Reid, and Silvio Savarese. Topnet: Structural point cloud decoder. In *The IEEE Conference on Computer Vision and Pattern Recognition (CVPR)*, June 2019.
- Marvin Teichmann, Andre Araujo, Menglong Zhu, and Jack Sim. Detect-to-retrieve: Efficient regional aggregation for image search. In *The IEEE Conference on Computer Vision and Pattern Recognition (CVPR)*, June 2019.

- Brian Teixeira, Vivek Singh, Terrence Chen, Kai Ma, Birgi Tamersoy, Yifan Wu, Elena Balashova, and Dorin Comaniciu. Generating synthetic x-ray images of a person from the surface geometry. In *The IEEE Conference on Computer Vision and Pattern Recognition (CVPR)*, June 2018.
- Ravi Teja Mullapudi, William R. Mark, Noam Shazeer, and Kayvon Fatahalian. Hydranets: Specialized dynamic architectures for efficient inference. In *The IEEE Conference on Computer Vision and Pattern Recognition (CVPR)*, June 2018.
- Bugra Tekin, Artem Rozantsev, Vincent Lepetit, and Pascal Fua. Direct prediction of 3d body poses from motion compensated sequences. In *The IEEE Conference on Computer Vision and Pattern Recognition (CVPR)*, June 2016.
- Bugra Tekin, Sudipta N. Sinha, and Pascal Fua. Real-time seamless single shot 6d object pose prediction. In *The IEEE Conference on Computer Vision and Pattern Recognition (CVPR)*, June 2018.
- Bugra Tekin, Federica Bogo, and Marc Pollefeys. H+o: Unified egocentric recognition of 3d hand-object poses and interactions. In *The IEEE Conference on Computer Vision and Pattern Recognition (CVPR)*, June 2019.
- Damien Teney and Anton van den Hengel. Actively seeking and learning from live data. In *The IEEE Conference on Computer Vision and Pattern Recognition (CVPR)*, June 2019.
- Damien Teney, Lingqiao Liu, and Anton van den Hengel. Graph-structured representations for visual question answering. In *The IEEE Conference on Computer Vision and Pattern Recognition (CVPR)*, July 2017.
- Damien Teney, Peter Anderson, Xiaodong He, and Anton van den Hengel. Tips and tricks for visual question answering: Learnings from the 2017 challenge. In *The IEEE Conference on Computer Vision and Pattern Recognition (CVPR)*, June 2018.
- Daniel Teo, Boxin Shi, Yinqiang Zheng, and Sai-Kit Yeung. Self-calibrating polarising radiometric calibration. In *The IEEE Conference on Computer Vision and Pattern Recognition (CVPR)*, June 2018.
- Mariano Tepper and Guillermo Sapiro. Nonnegative matrix underapproximation for robust multiple model fitting. In *The IEEE Conference on Computer Vision and Pattern Recognition (CVPR)*, July 2017.
- Matthew Tesfaldet, Marcus A. Brubaker, and Konstantinos G. Derpanis. Two-stream convolutional networks for dynamic texture synthesis. In *The IEEE Conference on Computer Vision and Pattern Recognition (CVPR)*, June 2018.
- Ayush Tewari, Michael Zollhöfer, Pablo Garrido, Florian Bernard, Hyeonwoo Kim, Patrick Pérez, and Christian Theobalt. Self-supervised multi-level face model learning for monocular reconstruction at over 250 Hz. In *The IEEE Conference on Computer Vision and Pattern Recognition (CVPR)*, June 2018.
- Ayush Tewari, Florian Bernard, Pablo Garrido, Gaurav Bharaj, Mohamed Elgharib, Hans-Peter Seidel, Patrick Perez, Michael Zollhofer, and Christian Theobalt. Fml: Face model learning from videos. In *The IEEE Conference on Computer Vision and Pattern Recognition (CVPR)*, June 2019.
- Rajkumar Theagarajan, Ming Chen, Bir Bhanu, and Jing Zhang. Shieldnets: Defending against adversarial attacks using probabilistic adversarial robustness. In *The IEEE Conference on Computer Vision and Pattern Recognition (CVPR)*, June 2019.
- Spyridon Thermos, Georgios Th. Papadopoulos, Petros Daras, and Gerasimos Potamianos. Deep affordance-grounded sensorimotor object recognition. In *The IEEE Conference on Computer Vision and Pattern Recognition (CVPR)*, July 2017.
- Justus Thies, Michael Zollhofer, Marc Stamminger, Christian Theobalt, and Matthias Niessner. Face2face: Real-time face capture and reenactment of rgb videos. In *The IEEE Conference on Computer Vision and Pattern Recognition (CVPR)*. June 2016.

- Janine Thoma, Danda Pani Paudel, Ajad Chhatkuli, Thomas Probst, and Luc Van Gool. Mapping, localization and path planning for image-based navigation using visual features and map. In *The IEEE Conference on Computer Vision and Pattern Recognition (CVPR)*, June 2019.
- Diego Thomas and Rin-ichiro Taniguchi. Augmented blendshapes for real-time simultaneous 3d head modeling and facial motion capture. In *The IEEE Conference on Computer Vision and Pattern Recognition (CVPR)*, June 2016.
- Maoqing Tian, Shuai Yi, Hongsheng Li, Shihua Li, Xuesen Zhang, Jianping Shi, Junjie Yan, and Xiaogang Wang. Eliminating background-bias for robust person re-identification. In *The IEEE Conference on Computer Vision and Pattern Recognition (CVPR)*, June 2018.
- Yurun Tian, Bin Fan, and Fuchao Wu. L2-net: Deep learning of discriminative patch descriptor in euclidean space. In *The IEEE Conference on Computer Vision and Pattern Recognition (CVPR)*, July 2017.
- Zhi Tian, Tong He, Chunhua Shen, and Youliang Yan. Decoders matter for semantic segmentation: Data-dependent decoding enables flexible feature aggregation. In *The IEEE Conference on Computer Vision and Pattern Recognition (CVPR)*, June 2019.
- Radu Timofte, Rasmus Rothe, and Luc Van Gool. Seven ways to improve example-based single image super resolution. In *The IEEE Conference on Computer Vision and Pattern Recognition (CVPR)*, June 2016.
- Tal TLusty, Tomer Michaeli, Tali Dekel, and Lihi Zelnik-Manor. Modifying non-local variations across multiple views. In *The IEEE Conference on Computer Vision and Pattern Recognition (CVPR)*, June 2018.
- George Toderici, Damien Vincent, Nick Johnston, Sung Jin Hwang, David Minnen, Joel Shor, and Michele Covell. Full resolution image compression with recurrent neural networks. In *The IEEE Conference on Computer Vision and Pattern Recognition (CVPR)*, July 2017.
- Pavel Tokmakov, Karteek Alahari, and Cordelia Schmid. Learning motion patterns in videos. In *The IEEE Conference on Computer Vision and Pattern Recognition (CVPR)*, July 2017.
- Yuji Tokozume, Yoshitaka Ushiku, and Tatsuya Harada. Between-class learning for image classification. In *The IEEE Conference on Computer Vision and Pattern Recognition (CVPR)*, June 2018.
- Hiroki Tokunaga, Yuki Teramoto, Akihiko Yoshizawa, and Ryoma Bise. Adaptive weighting multi-field-of-view cnn for semantic segmentation in pathology. In *The IEEE Conference on Computer Vision and Pattern Recognition (CVPR)*, June 2019.
- Giorgos Toliás and Ondrej Chum. Asymmetric feature maps with application to sketch based retrieval. In *The IEEE Conference on Computer Vision and Pattern Recognition (CVPR)*, July 2017.
- Denis Tome, Chris Russell, and Lourdes Agapito. Lifting from the deep: Convolutional 3d pose estimation from a single image. In *The IEEE Conference on Computer Vision and Pattern Recognition (CVPR)*, July 2017.
- Matteo Tomei, Marcella Cornia, Lorenzo Baraldi, and Rita Cucchiara. Art2real: Unfolding the reality of artworks via semantically-aware image-to-image translation. In *The IEEE Conference on Computer Vision and Pattern Recognition (CVPR)*, June 2019.
- Bin Tong, Chao Wang, Martin Klinkigt, Yoshiyuki Kobayashi, and Yuuichi Nonaka. Hierarchical disentanglement of discriminative latent features for zero-shot learning. In *The IEEE Conference on Computer Vision and Pattern Recognition (CVPR)*, June 2019.
- Alessio Tonioni, Fabio Tosi, Matteo Poggi, Stefano Mattoccia, and Luigi Di Stefano. Real-time self-adaptive deep stereo. In *The IEEE Conference on Computer Vision and Pattern Recognition (CVPR)*, June 2019.

- Fabio Tosi, Filippo Aleotti, Matteo Poggi, and Stefano Mattoccia. Learning monocular depth estimation infusing traditional stereo knowledge. In *The IEEE Conference on Computer Vision and Pattern Recognition (CVPR)*, June 2019.
- Matthew Trager, Martial Hebert, and Jean Ponce. Consistency of silhouettes and their duals. In *The IEEE Conference on Computer Vision and Pattern Recognition (CVPR)*, June 2016.
- Matthew Trager, Bernd Sturmfels, John Canny, Martial Hebert, and Jean Ponce. General models for rational cameras and the case of two-slit projections. In *The IEEE Conference on Computer Vision and Pattern Recognition (CVPR)*, July 2017.
- Matthew Trager, Martial Hebert, and Jean Ponce. Coordinate-free carlsson-weinshall duality and relative multi-view geometry. In *The IEEE Conference on Computer Vision and Pattern Recognition (CVPR)*, June 2019.
- Du Tran, Heng Wang, Lorenzo Torresani, Jamie Ray, Yann LeCun, and Manohar Paluri. A closer look at spatiotemporal convolutions for action recognition. In *The IEEE Conference on Computer Vision and Pattern Recognition (CVPR)*, June 2018.
- Luan Tran, Xiaoming Liu, Jiayu Zhou, and Rong Jin. Missing modalities imputation via cascaded residual autoencoder. In *The IEEE Conference on Computer Vision and Pattern Recognition (CVPR)*, July 2017.
- Luan Tran, Feng Liu, and Xiaoming Liu. Towards high-fidelity nonlinear 3d face morphable model. In *The IEEE Conference on Computer Vision and Pattern Recognition (CVPR)*, June 2019.
- Wayne Treible, Philip Saponaro, Scott Sorensen, Abhishek Kolagunda, Michael O’Neal, Brian Phelan, Kelly Sherbondy, and Chandra Kambhampettu. Cats: A color and thermal stereo benchmark. In *The IEEE Conference on Computer Vision and Pattern Recognition (CVPR)*, July 2017.
- George Trigeorgis, Patrick Snape, Mihalis A. Nicolaou, Epameinondas Antonakos, and Stefanos Zafeiriou. Mnemonic descent method: A recurrent process applied for end-to-end face alignment. In *The IEEE Conference on Computer Vision and Pattern Recognition (CVPR)*, June 2016.
- George Trigeorgis, Patrick Snape, Iasonas Kokkinos, and Stefanos Zafeiriou. Face normals ”in-the-wild” using fully convolutional networks. In *The IEEE Conference on Computer Vision and Pattern Recognition (CVPR)*, July 2017.
- Shashank Tripathi, Siddhartha Chandra, Amit Agrawal, Amrith Tyagi, James M. Rehg, and Visesh Chari. Learning to generate synthetic data via compositing. In *The IEEE Conference on Computer Vision and Pattern Recognition (CVPR)*, June 2019.
- Elena Trunz, Sebastian Merzbach, Jonathan Klein, Thomas Schulze, Michael Weinmann, and Reinhard Klein. Inverse procedural modeling of knitwear. In *The IEEE Conference on Computer Vision and Pattern Recognition (CVPR)*, June 2019.
- Chia-Yin Tsai, Aswin C. Sankaranarayanan, and Ioannis Gkioulekas. Beyond volumetric albedo – a surface optimization framework for non-line-of-sight imaging. In *The IEEE Conference on Computer Vision and Pattern Recognition (CVPR)*, June 2019.
- Yi-Hsuan Tsai, Ming-Hsuan Yang, and Michael J. Black. Video segmentation via object flow. In *The IEEE Conference on Computer Vision and Pattern Recognition (CVPR)*, June 2016.
- Yi-Hsuan Tsai, Xiaohui Shen, Zhe Lin, Kalyan Sunkavalli, Xin Lu, and Ming-Hsuan Yang. Deep image harmonization. In *The IEEE Conference on Computer Vision and Pattern Recognition (CVPR)*, July 2017.
- Yi-Hsuan Tsai, Wei-Chih Hung, Samuel Schulter, Kihyuk Sohn, Ming-Hsuan Yang, and Manmohan Chandraker. Learning to adapt structured output space for semantic segmentation. In *The IEEE Conference on Computer Vision and Pattern Recognition (CVPR)*, June 2018.
- Kuan-Lun Tseng, Yen-Liang Lin, Winston Hsu, and Chung-Yang Huang. Joint sequence learning and cross-modality convolution for 3d biomedical segmentation. In *The IEEE Conference on Computer Vision and Pattern Recognition (CVPR)*. July 2017.

- Yusuke Tsuzuku and Issei Sato. On the structural sensitivity of deep convolutional networks to the directions of fourier basis functions. In *The IEEE Conference on Computer Vision and Pattern Recognition (CVPR)*, June 2019.
- Wei-Chih Tu, Shengfeng He, Qingxiong Yang, and Shao-Yi Chien. Real-time salient object detection with a minimum spanning tree. In *The IEEE Conference on Computer Vision and Pattern Recognition (CVPR)*, June 2016.
- Wei-Chih Tu, Ming-Yu Liu, Varun Jampani, Deqing Sun, Shao-Yi Chien, Ming-Hsuan Yang, and Jan Kautz. Learning superpixels with segmentation-aware affinity loss. In *The IEEE Conference on Computer Vision and Pattern Recognition (CVPR)*, June 2018.
- Radu Tudor Ionescu, Bogdan Alexe, Marius Leordeanu, Marius Popescu, Dim P. Papadopoulos, and Vittorio Ferrari. How hard can it be? estimating the difficulty of visual search in an image. In *The IEEE Conference on Computer Vision and Pattern Recognition (CVPR)*, June 2016.
- Shubham Tulsiani, Tinghui Zhou, Alexei A. Efros, and Jitendra Malik. Multi-view supervision for single-view reconstruction via differentiable ray consistency. In *The IEEE Conference on Computer Vision and Pattern Recognition (CVPR)*, July 2017.
- Shubham Tulsiani, Saurabh Gupta, David F. Fouhey, Alexei A. Efros, and Jitendra Malik. Factoring shape, pose, and layout from the 2d image of a 3d scene. In *The IEEE Conference on Computer Vision and Pattern Recognition (CVPR)*, June 2018.
- Sergey Tulyakov, Xavier Alameda-Pineda, Elisa Ricci, Lijun Yin, Jeffrey F. Cohn, and Nicu Sebe. Self-adaptive matrix completion for heart rate estimation from face videos under realistic conditions. In *The IEEE Conference on Computer Vision and Pattern Recognition (CVPR)*, June 2016.
- Sergey Tulyakov, Ming-Yu Liu, Xiaodong Yang, and Jan Kautz. Mocogan: Decomposing motion and content for video generation. In *The IEEE Conference on Computer Vision and Pattern Recognition (CVPR)*, June 2018.
- Hsiao-Yu Tung, Adam W. Harley, Liang-Kang Huang, and Katerina Fragkiadaki. Reward learning from narrated demonstrations. In *The IEEE Conference on Computer Vision and Pattern Recognition (CVPR)*, June 2018.
- Hsiao-Yu Fish Tung, Ricson Cheng, and Katerina Fragkiadaki. Learning spatial common sense with geometry-aware recurrent networks. In *The IEEE Conference on Computer Vision and Pattern Recognition (CVPR)*, June 2019.
- Javier S. Turek and Alexander G. Huth. Efficient, sparse representation of manifold distance matrices for classical scaling. In *The IEEE Conference on Computer Vision and Pattern Recognition (CVPR)*, June 2018.
- Lachlan Tychsen-Smith and Lars Petersson. Improving object localization with fitness nms and bounded iou loss. In *The IEEE Conference on Computer Vision and Pattern Recognition (CVPR)*, June 2018.
- Eric Tzeng, Judy Hoffman, Kate Saenko, and Trevor Darrell. Adversarial discriminative domain adaptation. In *The IEEE Conference on Computer Vision and Pattern Recognition (CVPR)*, July 2017.
- Takeshi Uemori, Atsushi Ito, Yusuke Moriuchi, Alexander Gatto, and Jun Murayama. Skin-based identification from multispectral image data using cnns. In *The IEEE Conference on Computer Vision and Pattern Recognition (CVPR)*, June 2019.
- Nikolai Ufer and Bjorn Ommer. Deep semantic feature matching. In *The IEEE Conference on Computer Vision and Pattern Recognition (CVPR)*, July 2017.
- Jasper Uijlings, Stefan Popov, and Vittorio Ferrari. Revisiting knowledge transfer for training object class detectors. In *The IEEE Conference on Computer Vision and Pattern Recognition (CVPR)*, June 2018.

- Ries Uittenbogaard, Clint Sebastian, Julien Vijverberg, Bas Boom, Dariu M. Gavrilă, and Peter H.N. de With. Privacy protection in street-view panoramas using depth and multi-view imagery. In *The IEEE Conference on Computer Vision and Pattern Recognition (CVPR)*, June 2019.
- Dmitry Ulyanov, Andrea Vedaldi, and Victor Lempitsky. Improved texture networks: Maximizing quality and diversity in feed-forward stylization and texture synthesis. In *The IEEE Conference on Computer Vision and Pattern Recognition (CVPR)*, July 2017.
- Dmitry Ulyanov, Andrea Vedaldi, and Victor Lempitsky. Deep image prior. In *The IEEE Conference on Computer Vision and Pattern Recognition (CVPR)*, June 2018.
- Benjamin Ummenhofer, Huizhong Zhou, Jonas Uhrig, Nikolaus Mayer, Eddy Ilg, Alexey Dosovitskiy, and Thomas Brox. Demon: Depth and motion network for learning monocular stereo. In *The IEEE Conference on Computer Vision and Pattern Recognition (CVPR)*, July 2017.
- Paul Upchurch, Jacob Gardner, Geoff Pleiss, Robert Pless, Noah Snavely, Kavita Bala, and Kilian Weinberger. Deep feature interpolation for image content changes. In *The IEEE Conference on Computer Vision and Pattern Recognition (CVPR)*, July 2017.
- Aisha Urooj and Ali Borji. Analysis of hand segmentation in the wild. In *The IEEE Conference on Computer Vision and Pattern Recognition (CVPR)*, June 2018.
- Anil Usumezbas, Ricardo Fabbri, and Benjamin B. Kimia. The surfacing of multiview 3d drawings via lofting and occlusion reasoning. In *The IEEE Conference on Computer Vision and Pattern Recognition (CVPR)*, July 2017.
- Jack Valmadre, Luca Bertinetto, Joao Henriques, Andrea Vedaldi, and Philip H. S. Torr. End-to-end representation learning for correlation filter based tracking. In *The IEEE Conference on Computer Vision and Pattern Recognition (CVPR)*, July 2017.
- Grant Van Horn, Steve Branson, Scott Loarie, Serge Belongie, and Pietro Perona. Lean multiclass crowdsourcing. In *The IEEE Conference on Computer Vision and Pattern Recognition (CVPR)*, June 2018.
- Gul Varol, Javier Romero, Xavier Martin, Naureen Mahmood, Michael J. Black, Ivan Laptev, and Cordelia Schmid. Learning from synthetic humans. In *The IEEE Conference on Computer Vision and Pattern Recognition (CVPR)*, July 2017.
- Subeesh Vasu and A. N. Rajagopalan. From local to global: Edge profiles to camera motion in blurred images. In *The IEEE Conference on Computer Vision and Pattern Recognition (CVPR)*, July 2017.
- Subeesh Vasu, Mahesh M. R. Mohan, and A. N. Rajagopalan. Occlusion-aware rolling shutter rectification of 3d scenes. In *The IEEE Conference on Computer Vision and Pattern Recognition (CVPR)*, June 2018.
- Ramakrishna Vedantam, Samy Bengio, Kevin Murphy, Devi Parikh, and Gal Chechik. Context-aware captions from context-agnostic supervision. In *The IEEE Conference on Computer Vision and Pattern Recognition (CVPR)*, July 2017.
- VSR Veeravasrapu, Constantin Rothkopf, and Ramesh Visvanathan. Adversarially tuned scene generation. In *The IEEE Conference on Computer Vision and Pattern Recognition (CVPR)*, July 2017.
- Andreas Veit, Serge Belongie, and Theofanis Karaletsos. Conditional similarity networks. In *The IEEE Conference on Computer Vision and Pattern Recognition (CVPR)*, July 2017.
- Andreas Veit, Maximilian Nickel, Serge Belongie, and Laurens van der Maaten. Separating self-expression and visual content in hashtag supervision. In *The IEEE Conference on Computer Vision and Pattern Recognition (CVPR)*, June 2018.
- Raviteja Vemulapalli and Aseem Agarwala. A compact embedding for facial expression similarity. In *The IEEE Conference on Computer Vision and Pattern Recognition (CVPR)*, June 2019.

- Raviteja Vemulapalli, Oncel Tuzel, Ming-Yu Liu, and Rama Chellapa. Gaussian conditional random field network for semantic segmentation. In *The IEEE Conference on Computer Vision and Pattern Recognition (CVPR)*, June 2016.
- Hemanth Venkateswara, Jose Eusebio, Shayok Chakraborty, and Sethuraman Panchanathan. Deep hashing network for unsupervised domain adaptation. In *The IEEE Conference on Computer Vision and Pattern Recognition (CVPR)*, July 2017.
- Carles Ventura, Miriam Bellver, Andreu Girbau, Amaia Salvador, Ferran Marques, and Xavier Giro-i Nieto. Rvos: End-to-end recurrent network for video object segmentation. In *The IEEE Conference on Computer Vision and Pattern Recognition (CVPR)*, June 2019.
- Subhashini Venugopalan, Lisa Anne Hendricks, Marcus Rohrbach, Raymond Mooney, Trevor Darrell, and Kate Saenko. Captioning images with diverse objects. In *The IEEE Conference on Computer Vision and Pattern Recognition (CVPR)*, July 2017.
- Cedric Verleysen and Christophe De Vleeschouwer. Piecewise-planar 3d approximation from wide-baseline stereo. In *The IEEE Conference on Computer Vision and Pattern Recognition (CVPR)*, June 2016.
- Nitika Verma, Edmond Boyer, and Jakob Verbeek. Feastnet: Feature-steered graph convolutions for 3d shape analysis. In *The IEEE Conference on Computer Vision and Pattern Recognition (CVPR)*, June 2018.
- Paul Vernaza and Manmohan Chandraker. Learning random-walk label propagation for weakly-supervised semantic segmentation. In *The IEEE Conference on Computer Vision and Pattern Recognition (CVPR)*, July 2017.
- Matthias Vestner, Roei Litman, Emanuele Rodola, Alex Bronstein, and Daniel Cremers. Product manifold filter: Non-rigid shape correspondence via kernel density estimation in the product space. In *The IEEE Conference on Computer Vision and Pattern Recognition (CVPR)*, July 2017.
- Alessandro Vianello, Jens Ackermann, Maximilian Diebold, and Bernd Jähne. Robust hough transform based 3d reconstruction from circular light fields. In *The IEEE Conference on Computer Vision and Pattern Recognition (CVPR)*, June 2018.
- Paul Vicol, Makarand Tapaswi, Lluís Castrejón, and Sanja Fidler. Moviegraphs: Towards understanding human-centric situations from videos. In *The IEEE Conference on Computer Vision and Pattern Recognition (CVPR)*, June 2018.
- Ruben Villegas, Jimei Yang, Duygu Ceylan, and Honglak Lee. Neural kinematic networks for unsupervised motion retargetting. In *The IEEE Conference on Computer Vision and Pattern Recognition (CVPR)*, June 2018.
- Minh Vo, Srinivasa G. Narasimhan, and Yaser Sheikh. Spatiotemporal bundle adjustment for dynamic 3d reconstruction. In *The IEEE Conference on Computer Vision and Pattern Recognition (CVPR)*, June 2016.
- Nam Vo, Lu Jiang, Chen Sun, Kevin Murphy, Li-Jia Li, Li Fei-Fei, and James Hays. Composing text and image for image retrieval - an empirical odyssey. In *The IEEE Conference on Computer Vision and Pattern Recognition (CVPR)*, June 2019.
- Paul Voigtlaender, Michael Krause, Aljosa Osep, Jonathon Luiten, Berin Balachandar Gnana Sekar, Andreas Geiger, and Bastian Leibe. Mots: Multi-object tracking and segmentation. In *The IEEE Conference on Computer Vision and Pattern Recognition (CVPR)*, June 2019.
- Anna Volokitin, Michael Gygli, and Xavier Boix. Predicting when saliency maps are accurate and eye fixations consistent. In *The IEEE Conference on Computer Vision and Pattern Recognition (CVPR)*, June 2016.
- Riccardo Volpi, Pietro Morerio, Silvio Savarese, and Vittorio Murino. Adversarial feature augmentation for unsupervised domain adaptation. In *The IEEE Conference on Computer Vision and Pattern Recognition (CVPR)*, June 2018.

- Carl Vondrick and Antonio Torralba. Generating the future with adversarial transformers. In *The IEEE Conference on Computer Vision and Pattern Recognition (CVPR)*, July 2017.
- Carl Vondrick, Hamed Pirsiavash, and Antonio Torralba. Anticipating visual representations from unlabeled video. In *The IEEE Conference on Computer Vision and Pattern Recognition (CVPR)*, June 2016.
- Jayakorn Vongkulbhisal, Ricardo Cabral, Fernando De la Torre, and Joao P. Costeira. Motion from structure (mfs): Searching for 3d objects in cluttered point trajectories. In *The IEEE Conference on Computer Vision and Pattern Recognition (CVPR)*, June 2016.
- Jayakorn Vongkulbhisal, Fernando De la Torre, and Joao P. Costeira. Discriminative optimization: Theory and applications to point cloud registration. In *The IEEE Conference on Computer Vision and Pattern Recognition (CVPR)*, July 2017.
- Jayakorn Vongkulbhisal, Beñat Irastorza Ugalde, Fernando De la Torre, and João P. Costeira. Inverse composition discriminative optimization for point cloud registration. In *The IEEE Conference on Computer Vision and Pattern Recognition (CVPR)*, June 2018.
- Jayakorn Vongkulbhisal, Phongtharin Vinayavekhin, and Marco Visentini-Scarzanella. Unifying heterogeneous classifiers with distillation. In *The IEEE Conference on Computer Vision and Pattern Recognition (CVPR)*, June 2019.
- Tuan-Hung Vu, Himalaya Jain, Maxime Bucher, Matthieu Cord, and Patrick Perez. Advent: Adversarial entropy minimization for domain adaptation in semantic segmentation. In *The IEEE Conference on Computer Vision and Pattern Recognition (CVPR)*, June 2019.
- Jorg Wagner, Jan Mathias Kohler, Tobias Gindele, Leon Hetzel, Jakob Thaddaus Wiedemer, and Sven Behnke. Interpretable and fine-grained visual explanations for convolutional neural networks. In *The IEEE Conference on Computer Vision and Pattern Recognition (CVPR)*, June 2019.
- Robert Walecki, Ognjen Rudovic, Vladimir Pavlovic, and Maja Pantic. Copula ordinal regression for joint estimation of facial action unit intensity. In *The IEEE Conference on Computer Vision and Pattern Recognition (CVPR)*, June 2016.
- Robert Walecki, Ognjen (Oggi) Rudovic, Vladimir Pavlovic, Bjoern Schuller, and Maja Pantic. Deep structured learning for facial action unit intensity estimation. In *The IEEE Conference on Computer Vision and Pattern Recognition (CVPR)*, July 2017.
- Chengde Wan, Thomas Probst, Luc Van Gool, and Angela Yao. Crossing nets: Combining gans and vaes with a shared latent space for hand pose estimation. In *The IEEE Conference on Computer Vision and Pattern Recognition (CVPR)*, July 2017.
- Fang Wan, Pengxu Wei, Jianbin Jiao, Zhenjun Han, and Qixiang Ye. Min-entropy latent model for weakly supervised object detection. In *The IEEE Conference on Computer Vision and Pattern Recognition (CVPR)*, June 2018.
- Fang Wan, Chang Liu, Wei Ke, Xiangyang Ji, Jianbin Jiao, and Qixiang Ye. C-mil: Continuation multiple instance learning for weakly supervised object detection. In *The IEEE Conference on Computer Vision and Pattern Recognition (CVPR)*, June 2019.
- Bastian Wandt and Bodo Rosenhahn. Repnet: Weakly supervised training of an adversarial reprojection network for 3d human pose estimation. In *The IEEE Conference on Computer Vision and Pattern Recognition (CVPR)*, June 2019.
- Chen Wang, Jianfei Yang, Lihua Xie, and Junsong Yuan. Kervolutional neural networks. In *The IEEE Conference on Computer Vision and Pattern Recognition (CVPR)*, June 2019.
- Kang Wang, Rui Zhao, and Qiang Ji. A hierarchical generative model for eye image synthesis and eye gaze estimation. In *The IEEE Conference on Computer Vision and Pattern Recognition (CVPR)*, June 2018.

- Lijun Wang, Huchuan Lu, Yifan Wang, Mengyang Feng, Dong Wang, Baocai Yin, and Xiang Ruan. Learning to detect salient objects with image-level supervision. In *The IEEE Conference on Computer Vision and Pattern Recognition (CVPR)*, July 2017.
- Shenlong Wang, Sean Ryan Fanello, Christoph Rhemann, Shahram Izadi, and Pushmeet Kohli. The global patch collider. In *The IEEE Conference on Computer Vision and Pattern Recognition (CVPR)*, June 2016.
- Ryan Webster, Julien Rabin, Loic Simon, and Frederic Jurie. Detecting overfitting of deep generative networks via latent recovery. In *The IEEE Conference on Computer Vision and Pattern Recognition (CVPR)*, June 2019.
- Jan D. Wegner, Steven Branson, David Hall, Konrad Schindler, and Pietro Perona. Cataloging public objects using aerial and street-level images - urban trees. In *The IEEE Conference on Computer Vision and Pattern Recognition (CVPR)*, June 2016.
- Jônatas Wehrmann and Rodrigo C. Barros. Bidirectional retrieval made simple. In *The IEEE Conference on Computer Vision and Pattern Recognition (CVPR)*, June 2018.
- Chen Wei, Lingxi Xie, Xutong Ren, Yingda Xia, Chi Su, Jiaying Liu, Qi Tian, and Alan L. Yuille. Iterative reorganization with weak spatial constraints: Solving arbitrary jigsaw puzzles for unsupervised representation learning. In *The IEEE Conference on Computer Vision and Pattern Recognition (CVPR)*, June 2019.
- Lingyu Wei, Qixing Huang, Duygu Ceylan, Etienne Vouga, and Hao Li. Dense human body correspondences using convolutional networks. In *The IEEE Conference on Computer Vision and Pattern Recognition (CVPR)*, June 2016.
- Longhui Wei, Shiliang Zhang, Wen Gao, and Qi Tian. Person transfer gan to bridge domain gap for person re-identification. In *The IEEE Conference on Computer Vision and Pattern Recognition (CVPR)*, June 2018.
- Yunchao Wei, Jiashi Feng, Xiaodan Liang, Ming-Ming Cheng, Yao Zhao, and Shuicheng Yan. Object region mining with adversarial erasing: A simple classification to semantic segmentation approach. In *The IEEE Conference on Computer Vision and Pattern Recognition (CVPR)*, July 2017.
- Maurice Weiler, Fred A. Hamprecht, and Martin Storath. Learning steerable filters for rotation equivariant cnns. In *The IEEE Conference on Computer Vision and Pattern Recognition (CVPR)*, June 2018.
- Philippe Weinzaepfel, Gabriela Csurka, Yohann Cabon, and Martin Humenberger. Visual localization by learning objects-of-interest dense match regression. In *The IEEE Conference on Computer Vision and Pattern Recognition (CVPR)*, June 2019.
- Qiang Wen, Yinjie Tan, Jing Qin, Wenxi Liu, Guoqiang Han, and Shengfeng He. Single image reflection removal beyond linearity. In *The IEEE Conference on Computer Vision and Pattern Recognition (CVPR)*, June 2019.
- Yandong Wen, Zhifeng Li, and Yu Qiao. Latent factor guided convolutional neural networks for age-invariant face recognition. In *The IEEE Conference on Computer Vision and Pattern Recognition (CVPR)*, June 2016.
- Chung-Yi Weng, Brian Curless, and Ira Kemelmacher-Shlizerman. Photo wake-up: 3d character animation from a single photo. In *The IEEE Conference on Computer Vision and Pattern Recognition (CVPR)*, June 2019.
- Junwu Weng, Chaoqun Weng, and Junsong Yuan. Spatio-temporal naive-bayes nearest-neighbor (st-nbnn) for skeleton-based action recognition. In *The IEEE Conference on Computer Vision and Pattern Recognition (CVPR)*, July 2017.
- Eric Wengrowski and Kristin Dana. Light field messaging with deep photographic steganography. In *The IEEE Conference on Computer Vision and Pattern Recognition (CVPR)*, June 2019.

- Davis Wertheimer and Bharath Hariharan. Few-shot learning with localization in realistic settings. In *The IEEE Conference on Computer Vision and Pattern Recognition (CVPR)*, June 2019.
- Matthew Wicker and Marta Kwiatkowska. Robustness of 3d deep learning in an adversarial setting. In *The IEEE Conference on Computer Vision and Pattern Recognition (CVPR)*, June 2019.
- Patrick Wieschollek, Oliver Wang, Alexander Sorkine-Hornung, and Hendrik P. A. Lensch. Efficient large-scale approximate nearest neighbor search on the gpu. In *The IEEE Conference on Computer Vision and Pattern Recognition (CVPR)*, June 2016.
- Maggie Wigness and John G. Rogers, III. Unsupervised semantic scene labeling for streaming data. In *The IEEE Conference on Computer Vision and Pattern Recognition (CVPR)*, July 2017.
- Erik Wijmans and Yasutaka Furukawa. Exploiting 2d floorplan for building-scale panorama rgb-d alignment. In *The IEEE Conference on Computer Vision and Pattern Recognition (CVPR)*, July 2017.
- Erik Wijmans, Samyak Datta, Oleksandr Maksymets, Abhishek Das, Georgia Gkioxari, Stefan Lee, Irfan Essa, Devi Parikh, and Dhruv Batra. Embodied question answering in photorealistic environments with point cloud perception. In *The IEEE Conference on Computer Vision and Pattern Recognition (CVPR)*, June 2019.
- Francis Williams, Teseo Schneider, Claudio Silva, Denis Zorin, Joan Bruna, and Daniele Panozzo. Deep geometric prior for surface reconstruction. In *The IEEE Conference on Computer Vision and Pattern Recognition (CVPR)*, June 2019.
- W. Williem and In Kyu Park. Robust light field depth estimation for noisy scene with occlusion. In *The IEEE Conference on Computer Vision and Pattern Recognition (CVPR)*, June 2016.
- Calden Wloka and John Tsotsos. Spatially binned roc: A comprehensive saliency metric. In *The IEEE Conference on Computer Vision and Pattern Recognition (CVPR)*, June 2016.
- Calden Wloka, Iuliia Kotseruba, and John K. Tsotsos. Active fixation control to predict saccade sequences. In *The IEEE Conference on Computer Vision and Pattern Recognition (CVPR)*, June 2018.
- Mark Wolff, Robert T. Collins, and Yanxi Liu. Regularity-driven facade matching between aerial and street views. In *The IEEE Conference on Computer Vision and Pattern Recognition (CVPR)*, June 2016.
- Alex Wong and Stefano Soatto. Bilateral cyclic constraint and adaptive regularization for unsupervised monocular depth prediction. In *The IEEE Conference on Computer Vision and Pattern Recognition (CVPR)*, June 2019.
- Daniel E. Worrall, Stephan J. Garbin, Daniyar Turmukhambetov, and Gabriel J. Brostow. Harmonic networks: Deep translation and rotation equivariance. In *The IEEE Conference on Computer Vision and Pattern Recognition (CVPR)*, July 2017.
- Mitchell Wortsman, Kiana Ehsani, Mohammad Rastegari, Ali Farhadi, and Roozbeh Mottaghi. Learning to learn how to learn: Self-adaptive visual navigation using meta-learning. In *The IEEE Conference on Computer Vision and Pattern Recognition (CVPR)*, June 2019.
- Chao-Yuan Wu, Christoph Feichtenhofer, Haoqi Fan, Kaiming He, Philipp Krahenbuhl, and Ross Girshick. Long-term feature banks for detailed video understanding. In *The IEEE Conference on Computer Vision and Pattern Recognition (CVPR)*, June 2019.
- Huikai Wu, Shuai Zheng, Junge Zhang, and Kaiqi Huang. Fast end-to-end trainable guided filter. In *The IEEE Conference on Computer Vision and Pattern Recognition (CVPR)*, June 2018.
- Jiajun Wu, Joshua B. Tenenbaum, and Pushmeet Kohli. Neural scene de-rendering. In *The IEEE Conference on Computer Vision and Pattern Recognition (CVPR)*, July 2017.
- Qi Wu, Chunhua Shen, Lingqiao Liu, Anthony Dick, and Anton van den Hengel. What value do explicit high level concepts have in vision to language problems? In *The IEEE Conference on Computer Vision and Pattern Recognition (CVPR)*. June 2016.

- Seoung Wug Oh, Michael S. Brown, Marc Pollefeys, and Seon Joo Kim. Do it yourself hyperspectral imaging with everyday digital cameras. In *The IEEE Conference on Computer Vision and Pattern Recognition (CVPR)*, June 2016.
- Seoung Wug Oh, Joon-Young Lee, Kalyan Sunkavalli, and Seon Joo Kim. Fast video object segmentation by reference-guided mask propagation. In *The IEEE Conference on Computer Vision and Pattern Recognition (CVPR)*, June 2018.
- Jonas Wulff, Laura Sevilla-Lara, and Michael J. Black. Optical flow in mostly rigid scenes. In *The IEEE Conference on Computer Vision and Pattern Recognition (CVPR)*, July 2017.
- Changqun Xia, Jia Li, Xiaowu Chen, Anlin Zheng, and Yu Zhang. What is and what is not a salient object? learning salient object detector by ensembling linear exemplar regressors. In *The IEEE Conference on Computer Vision and Pattern Recognition (CVPR)*, July 2017.
- Gui-Song Xia, Xiang Bai, Jian Ding, Zhen Zhu, Serge Belongie, Jiebo Luo, Mihai Datcu, Marcello Pelillo, and Liangpei Zhang. Dota: A large-scale dataset for object detection in aerial images. In *The IEEE Conference on Computer Vision and Pattern Recognition (CVPR)*, June 2018.
- Ke Xian, Chunhua Shen, Zhiguo Cao, Hao Lu, Yang Xiao, Ruibo Li, and Zhenbo Luo. Monocular relative depth perception with web stereo data supervision. In *The IEEE Conference on Computer Vision and Pattern Recognition (CVPR)*, June 2018.
- Yongqin Xian, Zeynep Akata, Gaurav Sharma, Quynh Nguyen, Matthias Hein, and Bernt Schiele. Latent embeddings for zero-shot classification. In *The IEEE Conference on Computer Vision and Pattern Recognition (CVPR)*, June 2016.
- Yongqin Xian, Bernt Schiele, and Zeynep Akata. Zero-shot learning - the good, the bad and the ugly. In *The IEEE Conference on Computer Vision and Pattern Recognition (CVPR)*, July 2017.
- Yongqin Xian, Subhabrata Choudhury, Yang He, Bernt Schiele, and Zeynep Akata. Semantic projection network for zero- and few-label semantic segmentation. In *The IEEE Conference on Computer Vision and Pattern Recognition (CVPR)*, June 2019.
- Chong Xiang, Charles R. Qi, and Bo Li. Generating 3d adversarial point clouds. In *The IEEE Conference on Computer Vision and Pattern Recognition (CVPR)*, June 2019.
- Chaowei Xiao, Dawei Yang, Bo Li, Jia Deng, and Mingyan Liu. Meshadv: Adversarial meshes for visual recognition. In *The IEEE Conference on Computer Vision and Pattern Recognition (CVPR)*, June 2019.
- Fanyi Xiao and Yong Jae Lee. Track and segment: An iterative unsupervised approach for video object proposals. In *The IEEE Conference on Computer Vision and Pattern Recognition (CVPR)*, June 2016.
- Huaxin Xiao, Jiashi Feng, Guosheng Lin, Yu Liu, and Maojun Zhang. Monet: Deep motion exploitation for video object segmentation. In *The IEEE Conference on Computer Vision and Pattern Recognition (CVPR)*, June 2018.
- Tong Xiao, Shuang Li, Bochao Wang, Liang Lin, and Xiaogang Wang. Joint detection and identification feature learning for person search. In *The IEEE Conference on Computer Vision and Pattern Recognition (CVPR)*, July 2017.
- Cihang Xie, Yuxin Wu, Laurens van der Maaten, Alan L. Yuille, and Kaiming He. Feature denoising for improving adversarial robustness. In *The IEEE Conference on Computer Vision and Pattern Recognition (CVPR)*, June 2019.
- Lingxi Xie, Liang Zheng, Jingdong Wang, Alan L. Yuille, and Qi Tian. Interactive: Inter-layer activeness propagation. In *The IEEE Conference on Computer Vision and Pattern Recognition (CVPR)*, June 2016.
- Saining Xie, Ross Girshick, Piotr Dollar, Zhuowen Tu, and Kaiming He. Aggregated residual transformations for deep neural networks. In *The IEEE Conference on Computer Vision and Pattern Recognition (CVPR)*, July 2017.

- Shuqin Xie, Zitian Chen, Chao Xu, and Cewu Lu. Environment upgrade reinforcement learning for non-differentiable multi-stage pipelines. In *The IEEE Conference on Computer Vision and Pattern Recognition (CVPR)*, June 2018.
- Shumian Xin, Sotiris Nousias, Kiriakos N. Kutulakos, Aswin C. Sankaranarayanan, Srinivasa G. Narasimhan, and Ioannis Gkioulekas. A theory of fermat paths for non-line-of-sight shape reconstruction. In *The IEEE Conference on Computer Vision and Pattern Recognition (CVPR)*, June 2019.
- Chao Xing, Xin Geng, and Hui Xue. Logistic boosting regression for label distribution learning. In *The IEEE Conference on Computer Vision and Pattern Recognition (CVPR)*, June 2016.
- Xianglei Xing, Tian Han, Ruiqi Gao, Song-Chun Zhu, and Ying Nian Wu. Unsupervised disentangling of appearance and geometry by deformable generator network. In *The IEEE Conference on Computer Vision and Pattern Recognition (CVPR)*, June 2019.
- Bo Xiong, Yannis Kalantidis, Deepti Ghadiyaram, and Kristen Grauman. Less is more: Learning highlight detection from video duration. In *The IEEE Conference on Computer Vision and Pattern Recognition (CVPR)*, June 2019.
- Wei Xiong, Wenhan Luo, Lin Ma, Wei Liu, and Jiebo Luo. Learning to generate time-lapse videos using multi-stage dynamic generative adversarial networks. In *The IEEE Conference on Computer Vision and Pattern Recognition (CVPR)*, June 2018.
- Zhiwei Xiong, Lizhi Wang, Huiqun Li, Dong Liu, and Feng Wu. Snapshot hyperspectral light field imaging. In *The IEEE Conference on Computer Vision and Pattern Recognition (CVPR)*, July 2017.
- Danfei Xu, Dragomir Anguelov, and Ashesh Jain. Pointfusion: Deep sensor fusion for 3d bounding box estimation. In *The IEEE Conference on Computer Vision and Pattern Recognition (CVPR)*, June 2018.
- Ning Xu, Brian Price, Scott Cohen, Jimei Yang, and Thomas S. Huang. Deep interactive object selection. In *The IEEE Conference on Computer Vision and Pattern Recognition (CVPR)*, June 2016.
- Shuangjie Xu, Daizong Liu, Linchao Bao, Wei Liu, and Pan Zhou. Mhp-vos: Multiple hypotheses propagation for video object segmentation. In *The IEEE Conference on Computer Vision and Pattern Recognition (CVPR)*, June 2019.
- Zhongwen Xu, Linchao Zhu, and Yi Yang. Few-shot object recognition from machine-labeled web images. In *The IEEE Conference on Computer Vision and Pattern Recognition (CVPR)*, July 2017.
- Jia Xue, Hang Zhang, Kristin Dana, and Ko Nishino. Differential angular imaging for material recognition. In *The IEEE Conference on Computer Vision and Pattern Recognition (CVPR)*, July 2017.
- Jia Xue, Hang Zhang, and Kristin Dana. Deep texture manifold for ground terrain recognition. In *The IEEE Conference on Computer Vision and Pattern Recognition (CVPR)*, June 2018.
- Nan Xue, Song Bai, Fudong Wang, Gui-Song Xia, Tianfu Wu, and Liangpei Zhang. Learning attraction field representation for robust line segment detection. In *The IEEE Conference on Computer Vision and Pattern Recognition (CVPR)*, June 2019.
- Takuma Yagi, Karttikeya Mangalam, Ryo Yonetani, and Yoichi Sato. Future person localization in first-person videos. In *The IEEE Conference on Computer Vision and Pattern Recognition (CVPR)*, June 2018.
- Tomas F. Yago Vicente, Minh Hoai, and Dimitris Samaras. Noisy label recovery for shadow detection in unfamiliar domains. In *The IEEE Conference on Computer Vision and Pattern Recognition (CVPR)*, June 2016.

- Noam Yair and Tomer Michaeli. Multi-scale weighted nuclear norm image restoration. In *The IEEE Conference on Computer Vision and Pattern Recognition (CVPR)*, June 2018.
- Hang Yan, Yebin Liu, and Yasutaka Furukawa. Turning an urban scene video into a cinemagraph. In *The IEEE Conference on Computer Vision and Pattern Recognition (CVPR)*, July 2017.
- Ke Yan, Xiaosong Wang, Le Lu, Ling Zhang, Adam P. Harrison, Mohammadhadi Bagheri, and Ronald M. Summers. Deep lesion graphs in the wild: Relationship learning and organization of significant radiology image findings in a diverse large-scale lesion database. In *The IEEE Conference on Computer Vision and Pattern Recognition (CVPR)*, June 2018.
- Qingsen Yan, Dong Gong, Qinfeng Shi, Anton van den Hengel, Chunhua Shen, Ian Reid, and Yanning Zhang. Attention-guided network for ghost-free high dynamic range imaging. In *The IEEE Conference on Computer Vision and Pattern Recognition (CVPR)*, June 2019.
- Hongyu Yang, Di Huang, Yunhong Wang, and Anil K. Jain. Learning face age progression: A pyramid architecture of gans. In *The IEEE Conference on Computer Vision and Pattern Recognition (CVPR)*, June 2018.
- Shijie Yang, Liang Li, Shuhui Wang, Weigang Zhang, and Qingming Huang. A graph regularized deep neural network for unsupervised image representation learning. In *The IEEE Conference on Computer Vision and Pattern Recognition (CVPR)*, July 2017.
- Xitong Yang, Xiaodong Yang, Ming-Yu Liu, Fanyi Xiao, Larry S. Davis, and Jan Kautz. Step: Spatio-temporal progressive learning for video action detection. In *The IEEE Conference on Computer Vision and Pattern Recognition (CVPR)*, June 2019.
- Zichao Yang, Xiaodong He, Jianfeng Gao, Li Deng, and Alex Smola. Stacked attention networks for image question answering. In *The IEEE Conference on Computer Vision and Pattern Recognition (CVPR)*, June 2016.
- Taiping Yao, Minsi Wang, Bingbing Ni, Huawei Wei, and Xiaokang Yang. Multiple granularity group interaction prediction. In *The IEEE Conference on Computer Vision and Pattern Recognition (CVPR)*, June 2018.
- Ting Yao, Tao Mei, and Yong Rui. Highlight detection with pairwise deep ranking for first-person video summarization. In *The IEEE Conference on Computer Vision and Pattern Recognition (CVPR)*, June 2016.
- Ting Yao, Yingwei Pan, Yehao Li, and Tao Mei. Incorporating copying mechanism in image captioning for learning novel objects. In *The IEEE Conference on Computer Vision and Pattern Recognition (CVPR)*, July 2017.
- Yuan Yao, Jianqiang Ren, Xuansong Xie, Weidong Liu, Yong-Jin Liu, and Jun Wang. Attention-aware multi-stroke style transfer. In *The IEEE Conference on Computer Vision and Pattern Recognition (CVPR)*, June 2019.
- Rajeev Yasarla and Vishal M. Patel. Uncertainty guided multi-scale residual learning-using a cycle spinning cnn for single image de-raining. In *The IEEE Conference on Computer Vision and Pattern Recognition (CVPR)*, June 2019.
- Hashim Yasin, Umar Iqbal, Bjorn Kruger, Andreas Weber, and Juergen Gall. A dual-source approach for 3d pose estimation from a single image. In *The IEEE Conference on Computer Vision and Pattern Recognition (CVPR)*, June 2016.
- Mark Yatskar, Luke Zettlemoyer, and Ali Farhadi. Situation recognition: Visual semantic role labeling for image understanding. In *The IEEE Conference on Computer Vision and Pattern Recognition (CVPR)*, June 2016.
- Mark Yatskar, Vicente Ordonez, Luke Zettlemoyer, and Ali Farhadi. Commonly uncommon: Semantic sparsity in situation recognition. In *The IEEE Conference on Computer Vision and Pattern Recognition (CVPR)*, July 2017.

- Jingwen Ye, Yixin Ji, Xinchao Wang, Kairi Ou, Dapeng Tao, and Mingli Song. Student becoming the master: Knowledge amalgamation for joint scene parsing, depth estimation, and more. In *The IEEE Conference on Computer Vision and Pattern Recognition (CVPR)*, June 2019.
- Jinmian Ye, Linnan Wang, Guangxi Li, Di Chen, Shandian Zhe, Xinqi Chu, and Zenglin Xu. Learning compact recurrent neural networks with block-term tensor decomposition. In *The IEEE Conference on Computer Vision and Pattern Recognition (CVPR)*, June 2018.
- Qixiang Ye, Tianliang Zhang, Wei Ke, Qiang Qiu, Jie Chen, Guillermo Sapiro, and Baochang Zhang. Self-learning scene-specific pedestrian detectors using a progressive latent model. In *The IEEE Conference on Computer Vision and Pattern Recognition (CVPR)*, July 2017.
- Adam B. Yedidia, Manel Baradad, Christos Thrampoulidis, William T. Freeman, and Gregory W. Wornell. Using unknown occluders to recover hidden scenes. In *The IEEE Conference on Computer Vision and Pattern Recognition (CVPR)*, June 2019.
- Raymond A. Yeh, Chen Chen, Teck Yian Lim, Alexander G. Schwing, Mark Hasegawa-Johnson, and Minh N. Do. Semantic image inpainting with deep generative models. In *The IEEE Conference on Computer Vision and Pattern Recognition (CVPR)*, July 2017.
- Raymond A. Yeh, Minh N. Do, and Alexander G. Schwing. Unsupervised textual grounding: Linking words to image concepts. In *The IEEE Conference on Computer Vision and Pattern Recognition (CVPR)*, June 2018.
- Raymond A. Yeh, Alexander G. Schwing, Jonathan Huang, and Kevin Murphy. Diverse generation for multi-agent sports games. In *The IEEE Conference on Computer Vision and Pattern Recognition (CVPR)*, June 2019.
- Florence Yellin, Benjamin D. Haeffele, Sophie Roth, and René Vidal. Multi-cell detection and classification using a generative convolutional model. In *The IEEE Conference on Computer Vision and Pattern Recognition (CVPR)*, June 2018.
- Donghun Yeo, Jeany Son, Bohyung Han, and Joon Hee Han. Superpixel-based tracking-by-segmentation using markov chains. In *The IEEE Conference on Computer Vision and Pattern Recognition (CVPR)*, July 2017.
- Serena Yeung, Olga Russakovsky, Greg Mori, and Li Fei-Fei. End-to-end learning of action detection from frame glimpses in videos. In *The IEEE Conference on Computer Vision and Pattern Recognition (CVPR)*, June 2016.
- Serena Yeung, Vignesh Ramanathan, Olga Russakovsky, Liyue Shen, Greg Mori, and Li Fei-Fei. Learning to learn from noisy web videos. In *The IEEE Conference on Computer Vision and Pattern Recognition (CVPR)*, July 2017.
- Anthony Yezzi, Ganesh Sundaramoorthi, and Minas Benyamin. Pde acceleration for active contours. In *The IEEE Conference on Computer Vision and Pattern Recognition (CVPR)*, June 2019.
- Li Yi, Hao Su, Xingwen Guo, and Leonidas J. Guibas. Syncspecnn: Synchronized spectral cnn for 3d shape segmentation. In *The IEEE Conference on Computer Vision and Pattern Recognition (CVPR)*, July 2017.
- Li Yi, Wang Zhao, He Wang, Minhyuk Sung, and Leonidas J. Guibas. Gspn: Generative shape proposal network for 3d instance segmentation in point cloud. In *The IEEE Conference on Computer Vision and Pattern Recognition (CVPR)*, June 2019.
- Ran Yi, Yong-Jin Liu, and Yu-Kun Lai. Content-sensitive supervoxels via uniform tessellations on video manifolds. In *The IEEE Conference on Computer Vision and Pattern Recognition (CVPR)*, June 2018.
- Wang Yifan, Shihao Wu, Hui Huang, Daniel Cohen-Or, and Olga Sorkine-Hornung. Patch-based progressive 3d point set upsampling. In *The IEEE Conference on Computer Vision and Pattern Recognition (CVPR)*, June 2019.

- Junho Yim, Donggyu Joo, Jihoon Bae, and Junmo Kim. A gift from knowledge distillation: Fast optimization, network minimization and transfer learning. In *The IEEE Conference on Computer Vision and Pattern Recognition (CVPR)*, July 2017.
- Guojun Yin, Bin Liu, Lu Sheng, Nenghai Yu, Xiaogang Wang, and Jing Shao. Semantics disentangling for text-to-image generation. In *The IEEE Conference on Computer Vision and Pattern Recognition (CVPR)*, June 2019.
- Ming Yin, Yi Guo, Junbin Gao, Zhaoshui He, and Shengli Xie. Kernel sparse subspace clustering on symmetric positive definite manifolds. In *The IEEE Conference on Computer Vision and Pattern Recognition (CVPR)*, June 2016.
- Zhichao Yin and Jianping Shi. Geonet: Unsupervised learning of dense depth, optical flow and camera pose. In *The IEEE Conference on Computer Vision and Pattern Recognition (CVPR)*, June 2018.
- Xingde Ying, Heng Guo, Kai Ma, Jian Wu, Zhengxin Weng, and Yefeng Zheng. X2ct-gan: Reconstructing ct from biplanar x-rays with generative adversarial networks. In *The IEEE Conference on Computer Vision and Pattern Recognition (CVPR)*, June 2019.
- Tatsuya Yokota and Hidekata Hontani. Simultaneous visual data completion and denoising based on tensor rank and total variation minimization and its primal-dual splitting algorithm. In *The IEEE Conference on Computer Vision and Pattern Recognition (CVPR)*, July 2017.
- Tatsuya Yokota, Burak Erem, Seyhmus Guler, Simon K. Warfield, and Hidekata Hontani. Missing slice recovery for tensors using a low-rank model in embedded space. In *The IEEE Conference on Computer Vision and Pattern Recognition (CVPR)*, June 2018.
- Masashi Yokozuka, Shuji Oishi, Simon Thompson, and Atsuhiko Banno. Vitamin-e: Visual tracking and mapping with extremely dense feature points. In *The IEEE Conference on Computer Vision and Pattern Recognition (CVPR)*, June 2019.
- Ryo Yonetani, Kris M. Kitani, and Yoichi Sato. Recognizing micro-actions and reactions from paired egocentric videos. In *The IEEE Conference on Computer Vision and Pattern Recognition (CVPR)*, June 2016.
- Donggeun Yoo and In So Kweon. Learning loss for active learning. In *The IEEE Conference on Computer Vision and Pattern Recognition (CVPR)*, June 2019.
- Jaeyoung Yoo, Sang-ho Lee, and Nojun Kwak. Image restoration by estimating frequency distribution of local patches. In *The IEEE Conference on Computer Vision and Pattern Recognition (CVPR)*, June 2018.
- YoungJoon Yoo, Kimin Yun, Sangdoon Yun, JongHee Hong, Hawook Jeong, and Jin Young Choi. Visual path prediction in complex scenes with crowded moving objects. In *The IEEE Conference on Computer Vision and Pattern Recognition (CVPR)*, June 2016.
- YoungJoon Yoo, Sangdoon Yun, Hyung Jin Chang, Yiannis Demiris, and Jin Young Choi. Variational autoencoded regression: High dimensional regression of visual data on complex manifold. In *The IEEE Conference on Computer Vision and Pattern Recognition (CVPR)*, July 2017.
- Jae Shin Yoon, Takaaki Shiratori, Shoou-I Yu, and Hyun Soo Park. Self-supervised adaptation of high-fidelity face models for monocular performance tracking. In *The IEEE Conference on Computer Vision and Pattern Recognition (CVPR)*, June 2019.
- Ryota Yoshihashi, Wen Shao, Rei Kawakami, Shaodi You, Makoto Iida, and Takeshi Naemura. Classification-reconstruction learning for open-set recognition. In *The IEEE Conference on Computer Vision and Pattern Recognition (CVPR)*, June 2019.
- Chong You, Daniel P. Robinson, and Rene Vidal. Provable self-representation based outlier detection in a union of subspaces. In *The IEEE Conference on Computer Vision and Pattern Recognition (CVPR)*, July 2017.

- Jinjie You, Ancong Wu, Xiang Li, and Wei-Shi Zheng. Top-push video-based person re-identification. In *The IEEE Conference on Computer Vision and Pattern Recognition (CVPR)*, June 2016.
- Kaichao You, Mingsheng Long, Zhangjie Cao, Jianmin Wang, and Michael I. Jordan. Universal domain adaptation. In *The IEEE Conference on Computer Vision and Pattern Recognition (CVPR)*, June 2019.
- Quanzeng You, Zhengyou Zhang, and Jiebo Luo. End-to-end convolutional semantic embeddings. In *The IEEE Conference on Computer Vision and Pattern Recognition (CVPR)*, June 2018.
- Aron Yu and Kristen Grauman. Thinking outside the pool: Active training image creation for relative attributes. In *The IEEE Conference on Computer Vision and Pattern Recognition (CVPR)*, June 2019.
- Fisher Yu, Vladlen Koltun, and Thomas Funkhouser. Dilated residual networks. In *The IEEE Conference on Computer Vision and Pattern Recognition (CVPR)*, July 2017.
- Qian Yu, Feng Liu, Yi-Zhe Song, Tao Xiang, Timothy M. Hospedales, and Chen-Change Loy. Sketch me that shoe. In *The IEEE Conference on Computer Vision and Pattern Recognition (CVPR)*, June 2016.
- Tan Yu, Jingjing Meng, and Junsong Yuan. Multi-view harmonized bilinear network for 3d object recognition. In *The IEEE Conference on Computer Vision and Pattern Recognition (CVPR)*, June 2018.
- Jun Yuan, Bingbing Ni, Xiaokang Yang, and Ashraf A. Kassim. Temporal action localization with pyramid of score distribution features. In *The IEEE Conference on Computer Vision and Pattern Recognition (CVPR)*, June 2016.
- Shanxin Yuan, Guillermo Garcia-Hernando, Björn Stenger, Gyeongsik Moon, Ju Yong Chang, Kyoung Mu Lee, Pavlo Molchanov, Jan Kautz, Sina Honari, Lihao Ge, Junsong Yuan, Xinghao Chen, Guijin Wang, Fan Yang, Kai Akiyama, Yang Wu, Qingfu Wan, Meysam Madadi, Sergio Escalera, Shile Li, Dongheui Lee, Iason Oikonomidis, Antonis Argyros, and Tae-Kyun Kim. Depth-based 3d hand pose estimation: From current achievements to future goals. In *The IEEE Conference on Computer Vision and Pattern Recognition (CVPR)*, June 2018.
- Tongtong Yuan, Weihong Deng, Jian Tang, Yinan Tang, and Binghui Chen. Signal-to-noise ratio: A robust distance metric for deep metric learning. In *The IEEE Conference on Computer Vision and Pattern Recognition (CVPR)*, June 2019.
- Zehuan Yuan, Jonathan C. Stroud, Tong Lu, and Jia Deng. Temporal action localization by structured maximal sums. In *The IEEE Conference on Computer Vision and Pattern Recognition (CVPR)*, July 2017.
- Jae-Seong Yun and Jae-Young Sim. Reflection removal for large-scale 3d point clouds. In *The IEEE Conference on Computer Vision and Pattern Recognition (CVPR)*, June 2018.
- Sangdoon Yun, Jongwon Choi, Youngjoon Yoo, Kimin Yun, and Jin Young Choi. Action-decision networks for visual tracking with deep reinforcement learning. In *The IEEE Conference on Computer Vision and Pattern Recognition (CVPR)*, July 2017.
- Victor Yurchenko and Victor Lempitsky. Parsing images of overlapping organisms with deep singling-out networks. In *The IEEE Conference on Computer Vision and Pattern Recognition (CVPR)*, July 2017.
- Amir Zadeh, Michael Chan, Paul Pu Liang, Edmund Tong, and Louis-Philippe Morency. Social-iq: A question answering benchmark for artificial social intelligence. In *The IEEE Conference on Computer Vision and Pattern Recognition (CVPR)*, June 2019.
- Alireza Zaeemzadeh, Mohsen Joneidi, Nazanin Rahnavard, and Mubarak Shah. Iterative projection and matching: Finding structure-preserving representatives and its application to computer vision. In *The IEEE Conference on Computer Vision and Pattern Recognition (CVPR)*, June 2019.

- Lazaros Zafeiriou, Epameinondas Antonakos, Stefanos Zafeiriou, and Maja Pantic. Joint unsupervised deformable spatio-temporal alignment of sequences. In *The IEEE Conference on Computer Vision and Pattern Recognition (CVPR)*, June 2016.
- Hasan F. M. Zaki, Faisal Shafait, and Ajmal Mian. Modeling sub-event dynamics in first-person action recognition. In *The IEEE Conference on Computer Vision and Pattern Recognition (CVPR)*, July 2017.
- Amir R. Zamir, Te-Lin Wu, Lin Sun, William B. Shen, Bertram E. Shi, Jitendra Malik, and Silvio Savarese. Feedback networks. In *The IEEE Conference on Computer Vision and Pattern Recognition (CVPR)*, July 2017.
- Amir R. Zamir, Alexander Sax, William Shen, Leonidas J. Guibas, Jitendra Malik, and Silvio Savarese. Taskonomy: Disentangling task transfer learning. In *The IEEE Conference on Computer Vision and Pattern Recognition (CVPR)*, June 2018.
- Andrei Zanfir, Elisabeta Marinoiu, and Cristian Sminchisescu. Monocular 3d pose and shape estimation of multiple people in natural scenes - the importance of multiple scene constraints. In *The IEEE Conference on Computer Vision and Pattern Recognition (CVPR)*, June 2018.
- Valentina Zantedeschi, Remi Emonet, and Marc Sebban. Metric learning as convex combinations of local models with generalization guarantees. In *The IEEE Conference on Computer Vision and Pattern Recognition (CVPR)*, June 2016.
- Rowan Zellers, Mark Yatskar, Sam Thomson, and Yejin Choi. Neural motifs: Scene graph parsing with global context. In *The IEEE Conference on Computer Vision and Pattern Recognition (CVPR)*, June 2018.
- Rowan Zellers, Yonatan Bisk, Ali Farhadi, and Yejin Choi. From recognition to cognition: Visual commonsense reasoning. In *The IEEE Conference on Computer Vision and Pattern Recognition (CVPR)*, June 2019.
- Oliver Zendel, Katrin Honauer, Markus Murschitz, Martin Humenberger, and Gustavo Fernandez Dominguez. Analyzing computer vision data - the good, the bad and the ugly. In *The IEEE Conference on Computer Vision and Pattern Recognition (CVPR)*, July 2017.
- Andy Zeng, Shuran Song, Matthias Niessner, Matthew Fisher, Jianxiong Xiao, and Thomas Funkhouser. 3dmatch: Learning local geometric descriptors from rgb-d reconstructions. In *The IEEE Conference on Computer Vision and Pattern Recognition (CVPR)*, July 2017.
- Yanhong Zeng, Jianlong Fu, Hongyang Chao, and Baining Guo. Learning pyramid-context encoder network for high-quality image inpainting. In *The IEEE Conference on Computer Vision and Pattern Recognition (CVPR)*, June 2019.
- Yu Zeng, Huchuan Lu, Lihe Zhang, Mengyang Feng, and Ali Borji. Learning to promote saliency detectors. In *The IEEE Conference on Computer Vision and Pattern Recognition (CVPR)*, June 2018.
- Menghua Zhai, Scott Workman, and Nathan Jacobs. Detecting vanishing points using global image context in a non-manhattan world. In *The IEEE Conference on Computer Vision and Pattern Recognition (CVPR)*, June 2016.
- Menghua Zhai, Zachary Bessinger, Scott Workman, and Nathan Jacobs. Predicting ground-level scene layout from aerial imagery. In *The IEEE Conference on Computer Vision and Pattern Recognition (CVPR)*, July 2017.
- Yao Zhai, Jingjing Fu, Yan Lu, and Houqiang Li. Feature selective networks for object detection. In *The IEEE Conference on Computer Vision and Pattern Recognition (CVPR)*, June 2018.
- Huangying Zhan, Ravi Garg, Chamara Saroj Weerasekera, Kejie Li, Harsh Agarwal, and Ian Reid. Unsupervised learning of monocular depth estimation and visual odometry with deep feature reconstruction. In *The IEEE Conference on Computer Vision and Pattern Recognition (CVPR)*, June 2018.

- Xiaohang Zhan, Xingang Pan, Ziwei Liu, Dahua Lin, and Chen Change Loy. Self-supervised learning via conditional motion propagation. In *The IEEE Conference on Computer Vision and Pattern Recognition (CVPR)*, June 2019.
- Feihu Zhang, Victor Prisacariu, Ruigang Yang, and Philip H.S. Torr. Ga-net: Guided aggregation net for end-to-end stereo matching. In *The IEEE Conference on Computer Vision and Pattern Recognition (CVPR)*, June 2019.
- Quanshi Zhang, Ruiming Cao, Ying Nian Wu, and Song-Chun Zhu. Mining object parts from cnns via active question-answering. In *The IEEE Conference on Computer Vision and Pattern Recognition (CVPR)*, July 2017.
- Yinda Zhang and Thomas Funkhouser. Deep depth completion of a single rgb-d image. In *The IEEE Conference on Computer Vision and Pattern Recognition (CVPR)*, June 2018.
- Zizhao Zhang, Fuyong Xing, Xiaoshuang Shi, and Lin Yang. Semicontour: A semi-supervised learning approach for contour detection. In *The IEEE Conference on Computer Vision and Pattern Recognition (CVPR)*, June 2016.
- Chen Zhao, Zhiguo Cao, Chi Li, Xin Li, and Jiaqi Yang. Nm-net: Mining reliable neighbors for robust feature correspondences. In *The IEEE Conference on Computer Vision and Pattern Recognition (CVPR)*, June 2019.
- Hao Zhao, Ming Lu, Anbang Yao, Yiwen Guo, Yurong Chen, and Li Zhang. Physics inspired optimization on semantic transfer features: An alternative method for room layout estimation. In *The IEEE Conference on Computer Vision and Pattern Recognition (CVPR)*, July 2017.
- Kaili Zhao, Wen-Sheng Chu, and Honggang Zhang. Deep region and multi-label learning for facial action unit detection. In *The IEEE Conference on Computer Vision and Pattern Recognition (CVPR)*, June 2016.
- Kaili Zhao, Wen-Sheng Chu, and Aleix M. Martinez. Learning facial action units from web images with scalable weakly supervised clustering. In *The IEEE Conference on Computer Vision and Pattern Recognition (CVPR)*, June 2018.
- Liangli Zhen, Peng Hu, Xu Wang, and Dezhong Peng. Deep supervised cross-modal retrieval. In *The IEEE Conference on Computer Vision and Pattern Recognition (CVPR)*, June 2019.
- Liang Zheng, Hengheng Zhang, Shaoyan Sun, Manmohan Chandraker, Yi Yang, and Qi Tian. Person re-identification in the wild. In *The IEEE Conference on Computer Vision and Pattern Recognition (CVPR)*, July 2017.
- Wenzhao Zheng, Zhaodong Chen, Jiwen Lu, and Jie Zhou. Hardness-aware deep metric learning. In *The IEEE Conference on Computer Vision and Pattern Recognition (CVPR)*, June 2019.
- Yinqiang Zheng and Laurent Kneip. A direct least-squares solution to the pnp problem with unknown focal length. In *The IEEE Conference on Computer Vision and Pattern Recognition (CVPR)*, June 2016.
- Yutong Zheng, Dipan K. Pal, and Marios Savvides. Ring loss: Convex feature normalization for face recognition. In *The IEEE Conference on Computer Vision and Pattern Recognition (CVPR)*, June 2018.
- Tiancheng Zhi, Bernardo R. Pires, Martial Hebert, and Srinivasa G. Narasimhan. Deep material-aware cross-spectral stereo matching. In *The IEEE Conference on Computer Vision and Pattern Recognition (CVPR)*, June 2018.
- Tiancheng Zhi, Bernardo R. Pires, Martial Hebert, and Srinivasa G. Narasimhan. Multispectral imaging for fine-grained recognition of powders on complex backgrounds. In *The IEEE Conference on Computer Vision and Pattern Recognition (CVPR)*, June 2019.
- Zhao Zhong, Junjie Yan, Wei Wu, Jing Shao, and Cheng-Lin Liu. Practical block-wise neural network architecture generation. In *The IEEE Conference on Computer Vision and Pattern Recognition (CVPR)*, June 2018.

- Zhun Zhong, Liang Zheng, Donglin Cao, and Shaozi Li. Re-ranking person re-identification with k-reciprocal encoding. In *The IEEE Conference on Computer Vision and Pattern Recognition (CVPR)*, July 2017.
- Zhun Zhong, Liang Zheng, Zhiming Luo, Shaozi Li, and Yi Yang. Invariance matters: Exemplar memory for domain adaptive person re-identification. In *The IEEE Conference on Computer Vision and Pattern Recognition (CVPR)*, June 2019.
- Tinghui Zhou, Philipp Krahenbuhl, Mathieu Aubry, Qixing Huang, and Alexei A. Efros. Learning dense correspondence via 3d-guided cycle consistency. In *The IEEE Conference on Computer Vision and Pattern Recognition (CVPR)*, June 2016.
- Xingyi Zhou, Jiacheng Zhuo, and Philipp Krahenbuhl. Bottom-up object detection by grouping extreme and center points. In *The IEEE Conference on Computer Vision and Pattern Recognition (CVPR)*, June 2019.
- Yanzhao Zhou, Qixiang Ye, Qiang Qiu, and Jianbin Jiao. Oriented response networks. In *The IEEE Conference on Computer Vision and Pattern Recognition (CVPR)*, July 2017.
- Yizhou Zhou, Xiaoyan Sun, Zheng-Jun Zha, and Wenjun Zeng. Mict: Mixed 3d/2d convolutional tube for human action recognition. In *The IEEE Conference on Computer Vision and Pattern Recognition (CVPR)*, June 2018.
- Xiangyu Zhu, Zhen Lei, Xiaoming Liu, Hailin Shi, and Stan Z. Li. Face alignment across large poses: A 3d solution. In *The IEEE Conference on Computer Vision and Pattern Recognition (CVPR)*, June 2016.
- Xinge Zhu, Jiangmiao Pang, Ceyuan Yang, Jianping Shi, and Dahua Lin. Adapting object detectors via selective cross-domain alignment. In *The IEEE Conference on Computer Vision and Pattern Recognition (CVPR)*, June 2019.
- Yuke Zhu, Joseph J. Lim, and Li Fei-Fei. Knowledge acquisition for visual question answering via iterative querying. In *The IEEE Conference on Computer Vision and Pattern Recognition (CVPR)*, July 2017.
- Zheng Zhu, Wei Wu, Wei Zou, and Junjie Yan. End-to-end flow correlation tracking with spatial-temporal attention. In *The IEEE Conference on Computer Vision and Pattern Recognition (CVPR)*, June 2018.
- Bohan Zhuang, Guosheng Lin, Chunhua Shen, and Ian Reid. Fast training of triplet-based deep binary embedding networks. In *The IEEE Conference on Computer Vision and Pattern Recognition (CVPR)*, June 2016.
- Bohan Zhuang, Lingqiao Liu, Yao Li, Chunhua Shen, and Ian Reid. Attend in groups: A weakly-supervised deep learning framework for learning from web data. In *The IEEE Conference on Computer Vision and Pattern Recognition (CVPR)*, July 2017.
- Bohan Zhuang, Qi Wu, Chunhua Shen, Ian Reid, and Anton van den Hengel. Parallel attention: A unified framework for visual object discovery through dialogs and queries. In *The IEEE Conference on Computer Vision and Pattern Recognition (CVPR)*, June 2018.
- Bohan Zhuang, Chunhua Shen, Mingkui Tan, Lingqiao Liu, and Ian Reid. Structured binary neural networks for accurate image classification and semantic segmentation. In *The IEEE Conference on Computer Vision and Pattern Recognition (CVPR)*, June 2019.
- Dimitri Zhukov, Jean-Baptiste Alayrac, Ramazan Gokberk Cinbis, David Fouhey, Ivan Laptev, and Josef Sivic. Cross-task weakly supervised learning from instructional videos. In *The IEEE Conference on Computer Vision and Pattern Recognition (CVPR)*, June 2019.
- Junbao Zhuo, Shuhui Wang, Shuhao Cui, and Qingming Huang. Unsupervised open domain recognition by semantic discrepancy minimization. In *The IEEE Conference on Computer Vision and Pattern Recognition (CVPR)*, June 2019.

- Wei Zhuo, Mathieu Salzmann, Xuming He, and Miaomiao Liu. Indoor scene parsing with instance segmentation, semantic labeling and support relationship inference. In *The IEEE Conference on Computer Vision and Pattern Recognition (CVPR)*, July 2017.
- Magauiya Zhussip, Shakarim Soltanayev, and Se Young Chun. Training deep learning based image denoisers from undersampled measurements without ground truth and without image prior. In *The IEEE Conference on Computer Vision and Pattern Recognition (CVPR)*, June 2019.
- Ev Zisselman, Jeremias Sulam, and Michael Elad. A local block coordinate descent algorithm for the csc model. In *The IEEE Conference on Computer Vision and Pattern Recognition (CVPR)*, June 2019.
- Aleksandar Zlateski, Ronnachai Jaroensri, Prafull Sharma, and Frédo Durand. On the importance of label quality for semantic segmentation. In *The IEEE Conference on Computer Vision and Pattern Recognition (CVPR)*, June 2018.
- Barret Zoph, Vijay Vasudevan, Jonathon Shlens, and Quoc V. Le. Learning transferable architectures for scalable image recognition. In *The IEEE Conference on Computer Vision and Pattern Recognition (CVPR)*, June 2018.
- Chuhang Zou, Alex Colburn, Qi Shan, and Derek Hoiem. Layoutnet: Reconstructing the 3d room layout from a single rgb image. In *The IEEE Conference on Computer Vision and Pattern Recognition (CVPR)*, June 2018.
- Fangyu Zou, Li Shen, Zequn Jie, Weizhong Zhang, and Wei Liu. A sufficient condition for convergences of adam and rmsprop. In *The IEEE Conference on Computer Vision and Pattern Recognition (CVPR)*, June 2019.
- Silvia Zuffi, Angjoo Kanazawa, David W. Jacobs, and Michael J. Black. 3d menagerie: Modeling the 3d shape and pose of animals. In *The IEEE Conference on Computer Vision and Pattern Recognition (CVPR)*, July 2017.
- Silvia Zuffi, Angjoo Kanazawa, and Michael J. Black. Lions and tigers and bears: Capturing non-rigid, 3d, articulated shape from images. In *The IEEE Conference on Computer Vision and Pattern Recognition (CVPR)*, June 2018.
- Syed Zulqarnain Gilani and Ajmal Mian. Learning from millions of 3d scans for large-scale 3d face recognition. In *The IEEE Conference on Computer Vision and Pattern Recognition (CVPR)*, June 2018.
- Yiming Zuo, Weichao Qiu, Lingxi Xie, Fangwei Zhong, Yizhou Wang, and Alan L. Yuille. Craves: Controlling robotic arm with a vision-based economic system. In *The IEEE Conference on Computer Vision and Pattern Recognition (CVPR)*, June 2019.
- Shay Zweig and Lior Wolf. Interponet, a brain inspired neural network for optical flow dense interpolation. In *The IEEE Conference on Computer Vision and Pattern Recognition (CVPR)*, July 2017.



CONFIDENTIAL COMMITTEE MATERIALS

SIGBOVIK'20 3-Blind Paper Review

Paper 17: GradSchoolNet: Robust end-to-end *-shot unsupervised deepAF neural attention model for convexly optimal (artificially intelligent) success in computer vision research

Reviewer: Definitely an expert and not a first-year grad student subreviewing

Rating: Strongest of Rejects

Confidence: Expert

I really wanted to like this paper, because the topic is interesting and because it is bad form to start reviewing a paper with the intention of hating it. Unfortunately, I got confused at a number of points while reading and just feel that the paper is too obscure for the SIGBOVIK audience. Here are some examples drawn from the first page, which is the only page that I can be sure the paper has.

1. I got completely lost on the second paragraph of p.1 and am sure that the average reader will as well. It's definitely not just me.
2. Your use of the term "it" is confusing. Am I supposed to know what "it" is supposed to refer to?
3. SIGBOVIK readers come from a wide variety of backgrounds and may not be familiar with what a "computer" is, though of course I am.
4. The definition of "algorithm", as I'm familiar with it, is "a set of rules for solving a problem in a finite number of steps, as for finding the greatest common divisor" [Dictionary.com]. I don't believe you're using this term correctly, as your paper does not mention greatest common divisors. It may not even mention algorithms, which would be an even more glaring flaw in the paper.

Natural Intelligence & Human Learning

25 **Sorting with human intelligence**

Cole Kurashige

Keywords: sorting, algorithm, crowd sourcing, human intelligence

26 **Synthesizing programs by asking people for help online**

Cassie Jones

Keywords: program synthesis, cloud computing, social computation, the real program synthesizer was the friends we made along the way

27 **HonkFast, PreHonk, HonkBack, PreHonkBack, HERS, Ad-Honk and AHC: The missing keys for autonomous driving**

Bernhard Egger, Max Siegel

Keywords: awesome paper, best paper award, great reviewer 3, awesome reviewer 2, marvelous reviewer 1

Sorting with Human Intelligence

Cole Kurashige
Harvey Mudd College

March
2020

Abstract

Many comparison-based sorting algorithms have been introduced in years past, but none are capable of comparing elements of two different types. We present a novel algorithm called `Turksort` which uses human intelligence to sort lists with truly arbitrary contents. We also present an implementation that can be found at <https://github.com/cole-k/turksort>. We analyze its performance with respect to time, accuracy, as well as a novel metric called monetary complexity.

1 Background

Lower bounds for time and space complexity have been long-established for comparison-based sorting algorithms. Many sorting algorithms have been developed which vary in the trade-offs they make for these complexities. Little has been done, however, to examine what it means to make a comparison.

In statically-typed programming languages like Java or C++, comparisons such as equal to (`==`) or greater than (`>`) are often restricted to operating on two elements of the same type¹. These languages consider it a compilation error to compare elements of differing types.

Dynamically-typed programming languages like Python do not consider it a compilation error; however, it is usually a runtime error to make these comparisons.

Listing 1: Comparisons in Python 3.7.6

```
>>> -1 > '-2'  
Traceback (most recent call last):  
  File "<stdin>", line 1, in <module>  
TypeError: '>' not supported between instances of 'int' and 'str'
```

JavaScript, ever the staunch opponent of reason, will gladly compare two objects of differing types. But just because JavaScript can do something does not mean that JavaScript does it right.

¹At least, without trickery or custom comparators.

It will correctly report that `-1` is greater than `"-2"`, but it erroneously considers `"-1"` less than `"-2"`. It also doesn't get that `"three"` is less than `"four"`, and it certainly does not know that `"one pound of feathers"` is just as heavy as `"one pound of bricks"`.

Listing 2: Comparisons in JavaScript (Node.js 12.12.0)

```
> -1 > "-2"
true
> "-1" > "-2"
false
> "three" < "four"
false
> "one pound of feathers" == "one pound of bricks"
false
```

Though it would be enjoyable to continue to mock JavaScript and its many questionable design choices, we cannot fault it much for these shortcomings.

JavaScript, like any programming language, interprets code. It treats queries like `"-1" > "-2"` as being a comparison on characters, not numbers, even if we humans can plainly see that JavaScript is being asked to compare negative one and negative two. But we cannot call JavaScript an idiot without calling it a savant. It can perform remarkably complex calculations in the blink of an eye or bring the fastest of hardware to a slow grind.

Computers are limited at processing much of the information that is so easy for us humans to immediately understand, like pictures of dogs or whether `"-1"` is greater than `"-2"`. And we are limited at processing much of the information that is so easy for computers to understand, like the exact colors of the millions of pixels in a picture of a dog or the product of two very large numbers.

Listing 3: Complex Operations in JavaScript (Node.js 12.12.0)

```
> 0.1 + 0.2
0.30000000000000004
> 1000000000 * 500000000
500000000000000000
```

Together, computers and humans can cover for each other's inadequacies, which is the premise of Human Intelligence Sorting. This type of sorting has yet to be realized in traditional sorting algorithms. At least until now.

2 Turksort

The idea behind Turksort is simple: let computers handle all of the sorting tedium and let humans handle all of the comparisons. It ends up being not that different from most sorting algorithms.

The algorithm differs only when two values need to be compared. When this happens, a form asking which of the two is greater² is generated. This

²"Neither" is an option, too.

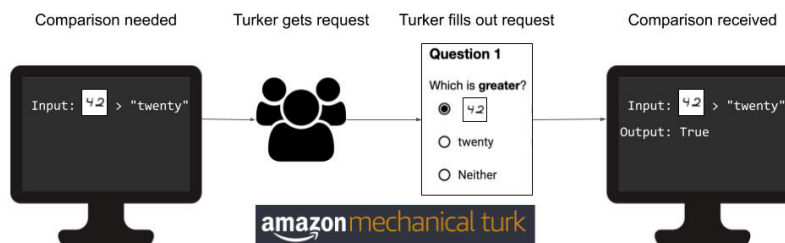

Figure 1: How Turksort comparisons work.

form is sent to Amazon’s Mechanical Turk (MTurk)³ where a worker (known as a “Turker”) fills it out. The answer is sent back and then used for the comparison. Figure 1 depicts this process.

An implementation of Turksort is available at <https://github.com/cole-k/turksort>. Any analyses in this paper will be with reference to this implementation. It is worth noting that Turksort refers to any algorithm that sorts using Turker-based comparisons, so other variants may be developed.

The implementation is a modification of quicksort. Quicksort works by selecting an element in the list (called the “pivot”) and comparing all of the other elements to it. It then partitions the list into three groups: those less than, equal to, or greater than the pivot. It recursively sorts all three partitions and combines them in order, producing a sorted array.

The partitioning process requires queries to be made comparing the pivot to each of the other elements in the list. These comparisons are collected and sent to MTurk for evaluation. This allows us to batch the computations, since querying MTurk is slow in comparison to regular comparison. The answers from MTurk are then used in the partitioning, and the algorithm proceeds as usual.

3 Analysis

In this section, we analyze the performance of Turksort (section 3.1) as well as its accuracy (section 3.2 on the following page).

3.1 Performance

Turksort is not an algorithm whose performance should be measured by traditional means. It, however, can be.

Since it retries until it gets a response from the Turker, Turksort technically has an unbounded time complexity. Even assuming that the response time from the Turker is bounded and proportionate to the query size, the asymptotic time complexity is that of quicksort. The average response time, even for shorter

³<https://www.mturk.com/>

queries, is around 5 minutes, so the constants on the time complexity are very large.

The novel performance measurement we propose for Turksort is a cost metric. We call it monetary complexity. This is the asymptotic cost of performing a computation. Because one currency differs from other currencies by a scaling factor, the monetary complexity's monetary base does not matter, much like logarithmic base in asymptotic complexity does not matter. We use a monetary base of USD.

It takes a Turker about 1 second to answer a single query. Since minimum wage in California is presently \$12.00, we pay 1 cent for every 3 queries a Turker answers, paying a floor of 1 cent if they are answering fewer than 3. We measured the monetary complexity of Turksort with respect to the number of elements in the list, with lists up to size 10000. We calculated the cost as being the average of five trials. Because the authors do not have any grant money, testing was done using a simulated Turker.

We introduce a new notation $\$(f(n))$ to denote monetary complexity: it means that a computation has cost asymptotically proportionate to $f(n)$. Turksort has a monetary complexity of $\$(n \log n)$; other common sorting algorithms have an effective monetary complexity of $\$(1)$ ⁴. You can observe this complexity in figure 2 on the next page.

It is evident that Turksort should only be used in cases where traditional computing does not have sufficient intelligence. The tradeoffs for using Turksort are both time and money, although common adages suggest that this is only a single tradeoff. In section 4 on the following page we discuss potential solutions to these tradeoffs. As it turns out, there is a third, unexpected tradeoff, which is accuracy. We discuss this below.

3.2 Accuracy

Surprisingly, Turksort is not a deterministic algorithm. This is because humans are not deterministic⁵. Not only is Turksort nondeterministic, it is also sometimes wrong. This is because Turkers do not always perform the right computations. Even on simple queries, such as $2 > 3$, they can give an incorrect answer.

This does not mean that Turksort is a useless sorting algorithm. There is a simple tradeoff between accuracy and speed: the less time a Turker spends answering a question, the more likely it is to be incorrect. Turksort is already not winning any races, and that is fine since it serves a specific purpose that regular sorting algorithms do not. So making it slightly slower for greater accuracy is a worthwhile tradeoff. We discuss how to mitigate the problem of accuracy by making more or slower queries in section 4 on the next page.

⁴Though they cost money by way of using electricity, this is a negligible cost and can be considered effectively constant.

⁵Although it is unknown whether individual humans are deterministic, in general no two humans perform comparisons exactly alike.

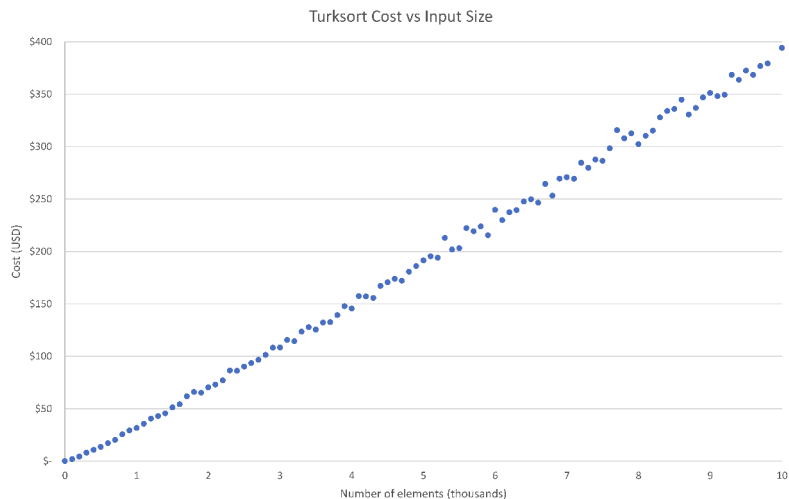

Figure 2: The monetary complexity of Turksort plotted for lists of size up to 10000.

4 Future Work

In the previous section, we discussed some limitations of Turksort. In this section we will discuss how these limitations may be overcome. Section 4.1 discusses ways to improve its accuracy and section 4.2 on the next page discusses ways to improve its performance. Turksort is very widely applicable and useful, so we do not need to mention potential applications or uses.

4.1 Improving Accuracy

The most important problem Turksort presently faces is an accuracy issue. There are two potential solutions.

First, Turkers could be forcibly slowed down by imposing a time limit before they can answer a comparison. This will prevent them from answering so fast that they get it wrong. The bulk of the time spent waiting in Turksort is in waiting for a Turker to start responding, so this will not extend the duration of the algorithm significantly, especially for shorter queries.

Second, Turksort could issue multiple requests for the same query. This way, majority voting from the Turkers could be used to increase the accuracy. Because these queries would be sent out in parallel, it is unlikely that this will have significant impacts on time. This has the additional benefit of making it easier for Turksort to sort so-called “trick comparisons,” like a query of “a pound of bricks” > “a pound of feathers”. If, during a computation, a query is suspected of being a “trick comparison,” the algorithm can take the minority response instead.

4.2 Improving Performance

Performance is less important for Turksort, given the time it takes to answer queries, but as the field of Human Intelligence Sorting grows, faster and cheaper variants will become more useful.

One way of improving performance is parallelization. Since queries take a long time to answer, Turksort could issue multiple queries at once. This can either be realized by modifying the underlying sorting algorithm to be more parallel, by making all $\binom{n}{2}$ comparison queries at once (thereby increasing the $\$(n \log n)$ monetary complexity to $\$(n^2)$), or by performing “branch prediction” and guessing what the next queries might be.

An obvious way of reducing the monetary complexity is to slow the rate at which Turkers are rewarded. Though it might seem illegal to not pay Turkers minimum wage, Turksort does not need to pay its Turkers since the gratification that they are advancing human progress is payment enough. However, without large constants, we believe $\$(1)$ Turksort algorithms to be impossible, as Turkers are not motivated by this gratification. We are presently exploring a $\$(\log^2 n)$ variant of Turksort.

5 Acknowledgements

We would like to acknowledge Arya Massarat, Andrew Pham, and Giselle Serate for testing the algorithm for $\$(1)$ monetary cost. We would also like to acknowledge all of the Turkers who tested the paid version of the algorithm. And we would finally like to acknowledge Andrew Pham, Giselle Serate, and Max Tepermeister for proof reading this paper.

Finally, we would like to acknowledge a blog post by Mikey Levine describing a similar idea with the same name⁶ for teaching us to search the internet more carefully after we come up with so-called “novel” ideas and then write papers on them. Indeed, careful inspection reveals that this general idea has been explored a few times prior, although thankfully not in the same ways as this paper.

⁶http://games.hazzens.com/blog/2014/02/27/turk_sort.html

Synthesizing Programs By Asking People For Help Online

Cassie Jones
Witch of Light
list+sigbovik@witchoflight.com

April 1, 2020

Abstract

Program Synthesis is a growing area of research, but most approaches are still limited by the difficulty of writing specifications and the lack of awareness of the software’s environment such as frameworks, operating systems, and deployment. We propose a distributed social method which satisfies these particular criteria at the cost of some scalability.

ACH Reference Format:

Cassie Jones. 2020. Synthesizing Programs By Asking People For Help Online. In *Proceedings of SIGBOVIK 2020*, Pittsburgh, PA, USA, April 1, 2020. (SIGBOVIK ’20, ACH).

Introduction

Traditional program synthesis is based on enumerating possible programs and checking if they match the specification, via directed search strategies and symbolic execution. For the most part, these take advantage of computers’ suitability for doing lots of brute-force work and careful checking.

Working with these synthesis systems involves writing precise specifications in a form that the synthesis tool understands, and then checking that the program output by the synthesizer matches the specification you *thought* you were writing. If there are ambiguities in your specification, synthesis tools will often find a way to solve the problem in the simplest way possible, even if that means it solves a different problem than the one you wanted. Synthesis tools are often quite slow for large programs, and are usually contained to limited domains, for example, writing pure functions over algebraic datatypes [3] or pointer manipulating programs. [4] Program synthesis tools are often oblivious to the function of systems considerations like the behavior of operating systems or external libraries, and adding knowledge of these is time consuming and contributes to synthesis performance problems.

More domain-specific synthesis tools are able to overcome many of these difficulties, since they only need to handle knowledge about their specific domain, but by their nature can’t synthesize general programs.

We attempt to solve these limitations by “asking people for help online.” We believe that this is a practical, currently deployable approach for producing software. It allows for natural language specifications and systems aware synthesis, and it can provide results all the way through to the deployment stage.

1 Our Approach

Our approach, “asking people for help online,” overcomes many of the difficulties that other program synthesis approaches suffer from. Since you’re asking people for help, they already possess natural language capabilities that we can take advantage of. Furthermore, “people” are able to “ask questions” to refine ambiguous specifications. Depending on your needs and who you’re able to find to help you, they can provide assistance ranging from suggesting what code you should write, to contributing changes themselves if they happen to be sufficiently interested.



Figure 1: The “asking for help online” approach, applied to a “hole” in a partially implemented C-Reduce interestingness predicate. The query resolved to an executable not yet installed on my machine, but which ended up being a good solution.

1.1 Specification Refinement

The first step in synthesis via asking people for help online, is to ask people for help online. To get the best results, you need to find the right place to ask. Some problems can be solved in general programming forums—for instance Stack Overflow can sometimes be helpful if they’re not mean to you. Sometimes, your question is too niche to get attention in those places. We have found it very effective to make friends with a variety of programmers in multiple timezones who like answering questions, and then asking on twitter when problems get too difficult or open-ended. If you’re integrating with a particular piece of software, library, or language, going to their communities can sometimes be your best bet, but friends are a good first target.

At this point, your synthesis query is a natural language question about the problem you need to solve. When you ask your question, you may get answers, or you may get questions in response about what you’re trying to do. If answers don’t match your intention, you can also provide extra information to direct the follow-up responses closer to your goal. This is the process of specification refinement, and it is negotiated transparently via the communication process involved in this approach. If you’re getting responses, at some point you’ll likely have a sufficient specification that someone can help you.

Synthesis queries can also be provided in the forms of partial programs with holes. You aren’t limited to sharing machine-readable text, you can even share an image of your partial program by taking a phone picture of your computer screen and sharing that while asking for advice. This is particularly beneficial when your development environment isn’t connected to the internet.



Figure 2: This is program synthesis. [1]

1.2 Environment Awareness

This synthesis method is aware of the program’s environment. It’s particular effective at integrating with large frameworks and APIs. When asking people for help online about a React problem or a Yosys problem for instance, there’s often help from people who work on those projects. This extends to many other domains and projects as well.

This synthesis approach applies to your whole system. You can use it to synthesize your install scripts, and match existing conventions for different ecosystems. People online are able to access sources of different projects and cite them as justifications, making this approach competitive with other approaches which datamine sources like GitHub. Asking in the right places (like the issue trackers of projects with bugs or missing features) can also synthesize code inside your dependencies, avoiding the need to fork those dependencies to make your changes.

1.3 Cross-Platform

Many synthesis tools are difficult to actually use outside the lab. They may have difficult-to-install dependencies, or only work on certain systems and with certain build approaches, or simply have bad interfaces with lots of set up. Our synthesis approach is fully cross-platform and compatible with existing workflows. Not only is it flexible to *literally any* system that the developer is using, the networked component is also highly

flexible. The examples included in this paper involved synthesis work via both IRC and Twitter, with crossover between the two.

```
21:11 <porglezomp> What's the recommended way to distribute extensions? As a
hack I'm installing them into a directory under the yosys data dir so that it
can find its files with +/<extension>/<stuff> paths. Is that fine?
21:20 <cr1901_modern> porglezomp: I found this: https://github.com/YosysHQ/yosys-plugins/blob/master/vhdl/Makefile#L27-L29
21:20 <cr1901_modern> Also this: https://github.com/tgingold/ghdlsynth-beta/blob/master/Makefile#L30-L32
21:21 <cr1901_modern> The honest answer in my experience is that "most ppl don't
actually make yosys plugins and just hack directly on yosys". But at least the
above two plugins seems to be consistent in install procedure
21:22 <porglezomp> Ok, nice, just need a slightly deeper subdir.
21:47 <porglezomp> Ah nice, now I can just do yosys -m nangate and things work!
21:52 <cr1901_modern> great :D!
```

Figure 3: The “asking for help online” approach can give results extracted from external data sources like GitHub, and provide synthesis that is tailored to the conventions of a particular software community. Also note that this synthesis query is solving a coupled deployment problem and implementation problem.

2 Future Directions

We were only able to evaluate this method by asking for help online. In theory, we believe our approach should naturally extend to asking for help locally, offline. This would have several tradeoffs. Relevant to industry deployment, it can keep the partial programs and specifications more confidential. The offline communication also has latency benefits, which can improve iterations time especially in the specification refinement stage. But, it has a smaller pool of help, and unfortunately, we didn’t have access to the local computational resources to evaluate this method, so its analysis must be left to future work.

This approach also shows promise in other domains of software engineering and programming language research, like fault localization and program repair. There are some domains like static type checking for dynamic languages where it could theoretically be deployed, but many of these domains overlap with others, and fall in the areas where this approach breaks down. Some of these domains like fault localization are potentially further automatable via technology like rubber ducks.

References [2]

- [1] Alice Avizandum. 2017. “Liberal: *through sobs* you can’t just say everything is nationalized... Please... Corbyn: *points at seagull flying past* nationalized”. Twitter. <https://twitter.com/aliceavizandum/status/875665911952416768>
- [2] Atticus Maisse. 2019. Hanging indents with a Pandoc bibliography. In *The T_EX and L^AT_EX Stack Exchange*. <https://tex.stackexchange.com/questions/477219/hanging-indents-with-a-pandoc-bibliography>
- [3] Nadia Polikarpova, Ivan Kuraj, and Armando Solar-Lezama. 2016. Program Synthesis from Polymorphic Refinement Types. In *Programming Language Design and Implementation 2016*, Santa Barbara, CA, USA, June 13–17, 2016. (PLDI ’16).
- [4] Nadia Polikarpova and Ilya Sergey. 2019. Structuring the Synthesis of Heap-Manipulating Programs. In *Proceedings of ACM Programming Languages 3*, POPL, Article 72. (January 2019). <https://doi.org/10.1145/3290385>

HonkFast, PreHonk, HonkBack, PreHonkBack, HERS, AdHonk and AHC: the Missing Keys for Autonomous Driving

Bernhard Egger* Max Siegel*

Magic Institute of Technology

{egger,maxs}@mit.edu

* Co-First and Co-Last Authors

Abstract

Autonomous cars are still not broadly deployed on our streets. We deeply investigated the remaining challenges and found that there is only one missing key: honking (“discovered in a flash of genius” [8]). We therefore propose several key ideas to solve this remaining challenge once and for all, to finally enable level 6 autonomous vehicles (level 5 + honking). We propose HonkFast, a system to honk fast; PreHonk, a mechanism to honk earlier; HonkBack, an algorithm to respond to honking; PreHonkBack a synergy of PreHonk and HonkBack; HERS, an efficient honking energy recovering system; AdHonk an adversarial attack for PreHonkBack to fully exploit the benefits of HERS, and AHC, an active honk cancelling system. We found that this invention not only enables autonomous driving, but also removes all current traffic issues with nonautonomous cars. Our simple and easy system can be added to every car and honks in perfection, “the potential impact of the proposed method is high.” [9].

1. Introduction

In this work [4] we propose HonkFast, PreHonk, HonkBack, PreHonkBack, HERS, AdHonk and AHC: the missing enabling technologies for autonomous driving. Just as pre-engine cars could not propel themselves (Figure 1), self-driving cars without the ability to honk cannot fully interact with human drivers. Accidents happen because of missing honking capabilities; it is clear that this paper is highly relevant, timely, and its publication of the utmost moral importance (in particular, should this work be rejected we can estimate and publish the consequent loss of life due to each reviewer). To learn more about autonomous driving we refer the valued reader to [6].

1.1 Related Work

The most related works are [11, 12]. Other researchers have identified honking as the missing ingredient for autonomous driving before, but seem to have struggled in bridging this final gap between current self-driving technology and full autonomy [1]. “(should we cite the crappy Gabor paper here?)” [2]

We would like to highlight that this research could not be more unrelated to [5]. The interested reader may contact the authors for a list of other unrelated work.

2. HonkFast

The idea of HonkFast is simple but powerful. Response time of humans is slow and can easily be outpaced by deep learning systems. We therefore propose to train an artificial neural network (ANN) based method to honk for us. Given enough training data (which



(a)



(b)

Figure 1. Pre-engine cars (a) could not propel themselves and hence were not true automobiles. Autonomous vehicles that cannot honk (b) are as far behind.

can trivially be collected in Boston) it can honk for us, e.g. when the light turns green.

3. PreHonk

Our initial trials with HonkFast revealed that the response time of the honking person – the honker – is only half of the full delay. The response time of the (human) target of the honk – the honkee – must be considered as well. To remove the lag of both response times we have to honk before the honk-causing event happens. We therefore train another ANN to predict honking events and to honk proactively rather than reactively. Our training objective is minimization of the time between the light turning green and the driver perceiving the change. In practice we find that the network honks approximately 300 milliseconds before the light changes.

Note that this ability requires precognition; to our knowledge our is the first method to develop precognition.

4. HonkBack

All of us have been honked at. There are several cases why somebody honks at us:

1. They are stupid idiots.
2. We made a mistake.
3. They are friends and want to say hi.

For all three cases there is one appropriate solution or response: we have to honk back as fast as possible. This should be a pretty easy task which probably could be solved by a Support Vector Machine (perhaps even without one weird kernel trick [10] (sponsored citation)); for simplicity we train an ANN. The main difficulty here is to only honk back if the honking event was aimed to us - however in practice this seems not to be relevant and it is of course appropriate to honk back to random honks.

5. PreHonkBack

In each case that we have so far considered it would be preferable to actually honk before other people honk at us. So, as for PreHonk, we must predict honking events of our fellow road users. This data is readily collected since drivers admit at least 2 honks per minute on an average road in Boston.

6. HERS: Honk Energy Recovery System

Everyday experience will suggest that there has been a dramatic increase in honking in recent years. Each honk consumes an average of 1,000,000 Wh. Especially in the age of growing demand for electric vehicles this is a dramatic number and after 3 honks the battery of a mid range electric vehicle is completely drained. So we propose to recover the energy from our own honks as well as those of everyone else. This system can provide our car battery with a clean source of energy. "Noise (sound) energy can be converted into viable source of electric power by using a suitable transducer." [7].

7. AdHonk: Adversarial Honking

A natural extension to HERS: The moment we can harness honk energy, we gain access to a very smart and easy strategy to recharge our battery. We charge it on the road by collecting all honk energy from surrounding vehicles. In case we run low on battery we further induce other vehicles to honk by causing honking events (for vehicles with a driver) or adversarial events (for autonomous honking cars from other manufacturers). (MAKE SURE TO REMOVE THIS BEFORE PUBLIC RELEASE, COULD LEAD TO HONKGATE).

8. AHS: Active Honk Cancelling

Finally our system might be uncomfortable (all that honking!) for passengers in the car. So we have to reduce ambient noise inside the car and actively remove all honking noises. We currently plan to use standard noise cancelling headphones but plan in future work to build a full car solution that reduces the noise without the need to wear headphones

Methods Whilst Deep Learning was recently heavily deployed for useless applications, we found impactful solutions to real problems in people's lives, based solely on outdated fully supervised learning algorithms.

9. Experiments and Results

We started training on a fancy cluster, but it is still running - loss gives NaNs. Potential causes include missing training data, NaNs in training data, and domestic or foreign security state apparatus. We however already evaluated our method using "(insert statistical method here)" [13]. We kindly ask the reviewers to not blame us for missing experiments, give us an outstanding rating. Completely unrelated to the review process we share a private key that might hold 7 Bitcoin after a positive review L2eFB5nMChDL3EH9DKoAr7SAjwQnZKvQ8Ff1V9aYA2SVLidRyh1x.

10. Immediate Positive Effects

This solution also applies to current non-autonomous cars in the short period before fully autonomous vehicles adopt our ideas. It resolves all traffic issues (at least in Boston) and reduces the danger of chronic honking elbow, caused by extensive manual honking.

11. Limitations

"There are none" [3]

12. Conclusion

In this study we have demonstrated electric cars being superior to steam trains. We also removed all doubts that public transport is not necessary in our glorious honking future.

References

- [1] Z. Chrid. Google's self-driving cars are also self-honking cars. *the verge*, 2016. URL <https://www.theverge.com/2016/6/2/11840352/google-self-driving-car-honk-autonomous-vehicle>.
- [2] Z. W. Culumber, C. E. Bautista-Hernández, S. Monks, L. Arias-Rodríguez, and M. Tobler. Variation in melanism and female preference in proximate but ecologically distinct environments. *Ethology*, 120(11):1090–1100, 2014.
- [3] J. C. Doyle. Guaranteed margins for lqg regulators. *IEEE Transactions on automatic Control*, 23(4):756–757, 1978.
- [4] B. Egger and M. Siegel. Honkfast, prehonk, honkback, prehonkback, hers, adhonk and ahc: the missing keys for autonomous driving. *SIGBOVIK (under careful review by very talented, outstanding reviewers)*, 2020.
- [5] B. Egger, W. A. Smith, A. Tewari, S. Wuhler, M. Zollhoefer, T. Beeler, F. Bernard, T. Bolkart, A. Kortylewski, S. Romdhani, et al. 3d morphable face models—past, present and future. *arXiv preprint arXiv:1909.01815*, 2019.
- [6] Everybody. All we know. *The Internet*, 2020. URL <https://lmgtyfy.com/?q=autonomous+driving>.
- [7] M. Garg, D. Gera, A. Bansal, and A. Kumar. Generation of electrical energy from sound energy. In *2015 International Conference on Signal Processing and Communication (ICSC)*, pages 410–412. IEEE, 2015.
- [8] Hobojaks. History of quaternions. *Wikipedia*, 2020. URL https://en.wikipedia.org/wiki/History_of_quaternions.
- [9] L. Maier-Hein, A. M. Franz, T. R. Dos Santos, M. Schmidt, M. Fangerau, H.-P. Meinzer, and J. M. Fitzpatrick. Convergent iterative closest-point algorithm to accommodate anisotropic and inhomogeneous localization error. *IEEE transactions on pattern analysis and machine intelligence*, 34(8):1520–1532, 2011.
- [10] D. Maturana and D. F. Fouhey. Find a separating hyperplane with this one weird kernel trick (sponsored citation). *SIGBOVIK*, 2013.
- [11] T. Onion. Engineers unveil new driverless car capable of committing hit-and-run. 2015. URL <https://www.theonion.com/engineers-unveil-new-driverless-car-capable-of-committi-1>

- [12] T. Onion. How do self-driving cars avoid driving straight to the beach? 2017. URL <https://www.theonion.com/how-do-self-driving-cars-avoid-driving-straight-to-the-1820047398>.
- [13] L. Xie, B. Weichel, J. E. Ohm, and K. Zhang. An integrative analysis of dna methylation and rna-seq data for human heart, kidney and liver. *BMC systems biology*, 5(S3):S4, 2011.



CONFIDENTIAL COMMITTEE MATERIALS

SIGBOVIK'20 3-Blind Paper Review

Paper 27: HonkFast, PreHonk, HonkBack, PreHonkBack, HERS, AdHonk and AHC: The missing keys for autonomous driving

Reviewer: See Em You, Ph.D.

Rating: PG-13

Confidence: (-1.23, 4.95)

This is a well prepared appetizer, which warrants menu publication. I admire the design and rigor of the dish, particularly the use of lime as a co-variant. I have three minor comments that should be addressed before publication. 1. There is a real concern for multicollinearity in the recipe. Remove the margarine and add more butter. 2. Please justify the use of almond milk over cow, soy, rice, oat, etc. (See Bernat et al., 2015 for discussion on probiotic *Lactobacillus reuteri* and *Streptococcus thermophilus*). 3. Is a vegetarian or vegan option available? This needs to be made clear in the discussion.

Education

28 A disproof of the Theorem of Triviality

Arul Kolla, August Deer, Ethan Kogan

Keywords: theorem of triviality, theorem, meta problems, meta,
math i guess

29 Visualizing player engagement with virtual spaces using GIS

Frederick Chan

Keywords: geographic information systems, virtual spaces, video
games, video game anthropology

30 How to git bisect when your test suite is having a bad day

ben blum

Keywords: pdflatex, cdflatex

A Disproof of the Theorem of Triviality

Arul Kolla, August Deer, Ethan Kogan

February 28, 2020

Abstract

We disprove the Theorem of Triviality, which claims that if one is asked to prove a statement K , then this statement must be true, since it is being asked. We then discuss some possible explorations of this idea.

1 Preliminaries

The theorem of triviality is a common theorem used among students trying to solve math problems. We restate it here.

Theorem 1 (Theorem of Triviality). *If one is asked to prove a statement K , then it must be true, since it is being asked.*

2 Disproof

We now disprove Theorem 1.

Proof. This statement is logically equal to its contrapositive, which is “if a statement is not true, then one will not be asked to prove it.” This is clearly false, as we can ask to prove the following two statements:

Prove that the Theorem of Triviality is true.

Prove that the Theorem of Triviality is false.

These two statements are complements, and so one must be false, contradicting the hypothesis. Hence the Theorem of Triviality is false. \square

3 Open Questions

We have also been considering this idea of “metaproofs” where we ask questions about proofs themselves; in specific, we ask for the answer to the following question: out of all conditional statements of the form “if A , then B ”, what percent are always true?

One can also muse what other “metaproblems” one can come up with, and make a problem about those metaproblems. We encourage readers to explore these questions and then make more questions about said questions.

Visualizing Player Engagement with Virtual Spaces using GIS

Frederick Chan
fredchan@uw.edu

University of Washington

1 Abstract

GIS software is meant for Earth data, but I demonstrate here that you can convert video game data and put it in GIS software anyway. This is used to reveal player trends and clean up virtual player-generated litter. I focus on getting heightmaps, locations of gameplay objects, and metadata of Minecraft maps, converting it to formats usable by QGIS, and interpreting what that data could mean so you get why this is practical.

2 Background

The Earth is round. You know this¹, I know this, and so do the developers of geographic information systems (GIS) software. GIS software is optimized for this fact, since its main job is to manipulate and analyze Earth data. Although it can be used for other planets and moons as well[4], these are all round-ish objects like Earth is. This is unlike most virtual spaces in video games, which are flat, but we can try putting those spaces in GIS software anyway.

It's helpful for game designers to understand where players go in these virtual spaces, called maps, to find out what map features attract players. This can even be used to weed out pesky camping spots, where players sit around and pick off unsuspecting passersby, which is annoying and unfair.[6] By looking at these maps in GIS and visualizing where people go, map design can be improved to promote a fair and more fun game environment. In this paper, I demonstrate the practicality of importing data sources from video games into GIS and provide examples of what insights this can lead to².

In particular, I'll be extracting data from two different maps, *EvanTest* and *Ships and Stuff*, played in *Minecraft*, a sandbox game where players collect virtual blocks and use them to build in-game structures on the procedurally generated map. Using Minecraft with GIS

is not unheard of, as GIS data has been imported into Minecraft for encouraging citizen participation in urban planning.[7] While that focuses on using real data in a video game to solve real problems, I aim to use video game data in software for real data to solve video game problems. It's obviously a very important cause.

Luckily, it's easy to import arbitrary data sources into Quantum GIS (QGIS) and not specify a map projection or coordinate reference system (CRS) that ties it to a real planet. The game's world is theoretically infinite, but is divided into regions of 32x32 chunks, each containing 16x16 blocks. Each region file stores chunk data in a well documented NBT format,[1] so it's easy to convert game data into data QGIS will understand. Each chunk stores its own heightmap, analogous to a digital surface model (DSM), representing the game world's surface and all the structures on it. Chunks also store the amount of time a chunk is loaded ("InhabitedTime" which is how long a player was in its vicinity recorded in ticks (0.05 seconds). By plotting these data on top of each other, we can see some interesting trends.

We can also plot the locations of undesired objects ("litter") in a map, such as repeating command blocks, which can cause an unpleasant, laggy gameplay experience when in excess. Plotting them on the heightmap shows the capability of players for altering the virtual terrain and creates a useful geographical reference for systematically cleaning up litter.

3 Converting game data

All the code is available at <https://github.com/fechan/MCGS> and written in Python. To extract the heightmaps, `extract_heightmaps.py` opens up a region file and looks at every chunk. Each chunk stores various heightmaps, but `OCEAN_FLOOR` is the one we're interested in, which stores the highest solid, non-air block. Each heightmap is a 64-bit array of longs, with every 9 bits being one elevation value between 0-256 (the height limit of the game). Knowing this, we can convert the heightmap into a Python list containing the elevations as integers

¹Unless, of course, you're a flat Earther.

²This is all one big excuse to show you what I've built in Minecraft with my friends.

with the following function³.

```
def unstream(value_bits, word_size, data):
    bl = 0
    v = 0
    decoded = []
    for i in range(len(data)):
        for n in range(word_size):
            bit = (data[i] >> n) & 0x01
            v = (bit << bl) | v
            bl += 1
            if bl >= value_bits:
                decoded.append(v)
                v = 0
                bl = 0
    return decoded
```

With the elevation data in a list, we can convert it into a geographic raster for QGIS. Since our heightmap represents a fictional, flat world, there's no real-world map projection or CRS that would be appropriate to apply, so we want to create a raster in a format that doesn't require one. The ESRI ASCII grid[2] is one of these, and has the added benefit of being extremely simple. We just define the (x,y) of the raster's lower-left corner to be the (x,z) of the Minecraft chunk and set the number of rows and columns to 16. Then we join the elements of our list of elevations using spaces and put it in the last line of the file⁴. Since there are 32×32 chunks in a region (that's a lot!), we can stitch each chunk raster into one big region raster with `gdal_merge`[3].

A similar thing is done by `plot_inhabitedtime.py` to get a plot of each chunk's InhabitedTime. This is just an integer, so we can just yoinck the values into a list, set the raster to a size of 32×32 cells at 16 units (blocks) per cell, and join the array into the raster file. Then we have a plot of each chunk's InhabitedTime for the entire region.

Both of these rasters can be loaded into QGIS, and rasters of the same region will be automatically superimposed.

In order to plot the locations of specific blocks, a different approach is used since locations of blocks is better represented by a vector layer of points. For this, we can use PyQGIS, QGIS's Python API, to generate one. In `ore_plot_qgis.py`, I use the `anvil-parser` Python library to determine the location of a particular block given its coordinate. With this, I can scan every block in the region for the blocks I want to plot. Once the

³This is a Python rewrite of a Perl subroutine written by u/ExtraStrengthFukitol on Reddit.

⁴Y is elevation in Minecraft, but Z is elevation in QGIS. One caveat is that -Z in Minecraft is north while +Y is north in QGIS. When exporting the heightmap, you can mirror it vertically so that north is up and QGIS's Y matches up with Minecraft's Z.

Python script is loaded into QGIS, I can run it and it will add a new layer with the plot. The block's precise location, including elevation, is stored in the attribute table.

4 Case study: Multiplayer survival

4.1 Background

EvanTest is a map generated and played on a multiplayer survival server that had 17 unique players in its playthrough. In survival, hostile mobs spawn that attack nearby players, who need food and shelter to survive. Players often take on goals such as defeating the powerful Ender Dragon, an end-game boss. To defeat it, players get resources to craft more powerful weapons and armor. Items can be made more powerful by enchanting them, sacrificing XP gained by killing mobs. In this playthrough, the players tended to divide themselves into two neighboring communities: Shack Village and Brazil. In Figure 1, the cluster of buildings on the left is Brazil and the cluster on the right is Shack Village.

4.2 Results

I successfully exported four regions' heightmaps and their InhabitedTime maps from Minecraft into QGIS, which is shown in Figures 1 and 2. Analyzing the statistics of the InhabitedTime raster of the main region of *EvanTest* where players inhabited indicates that chunks in the region were loaded for anywhere between 3,378 to 13,734,633 ticks (≈ 3 minutes to 191 hours), with a mean of 1,887,419 ticks (≈ 26 hours) and standard deviation of 3,366,901 ticks (≈ 47 hours). Complete maps of the whole area are in Appendix A: *EvanTest* Maps.

4.3 Discussion

To get food, players need access to farms. To craft items, they need access to mines, crafting tables, furnaces. Special resources required to craft certain items are also only available by traversing through Nether portals, special structures that players build. It is therefore unsurprising that people tend to hang around the metropolitan area (Figure 1), where all of these are available within a short distance. It's important to note that a chunk's InhabitedTime is only a measure of whether a chunk is loaded (within viewing distance of a player) and not whether a player was actually inside the chunk at the time. When a player is in a chunk, that player contributes to the InhabitedTime of all the chunks within their vision in a circle. As such, there are chunks in the metropolitan area with the highest InhabitedTime that

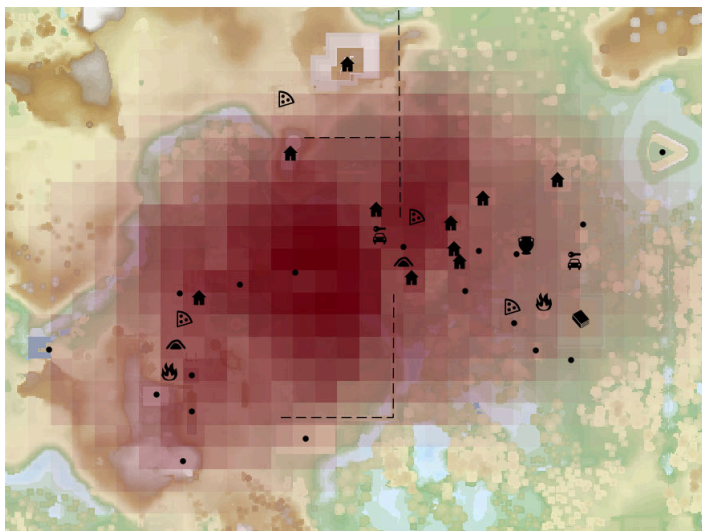

Figure 1: Pseudocolor map of the heightmap of the Shack Village-Brazil Metropolitan Area, with Inhabited-Time map on top, and labels indicating the type of building underneath. House icons are player houses, vases are storage areas, cars are storage areas for horses, pizzas are food farms, caves are mines, fires are Nether portals, books are enchanting-related buildings, and dots are miscellaneous. Permanent transportation infrastructure, like minecart rails, are indicated with dotted lines.

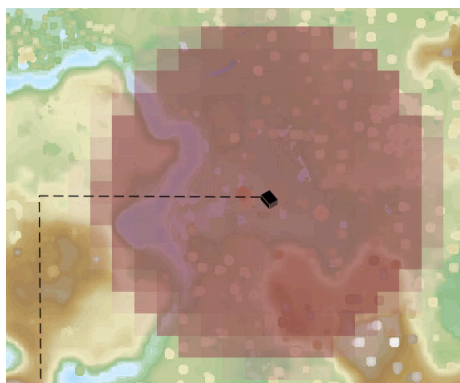

Figure 2: Map of the Mob spawner and AFK fishing hole. The dotted line is connected with the dotted line going up Figure 1 by extra rail in between. (See Appendix A for more detail).

have paradoxically few buildings. This is probably because it's the intersection of circles (imagine the middle of a Venn Diagram) around the urban cores of Shack Village and Brazil respectively, and not because people spend a lot of time hanging around the Colosseum between them, which is decorative and serves no gameplay purpose.

The second hot zone, completely separate from the metropolitan area, is the Mob spawner and AFK fishing area. Being one of only two available enchanting buildings, it is important for being the only convenient and readily available source of XP required for enchanting. This is due to the mob spawner block within, generated upon map creation, that cannot be moved. Players sit around the mob spawner and kill mobs for XP. Inside the building are other facilities dedicated to enchanting, such as the enchanting table and AFK fishing area. The AFK fishing area in particular is a tremendous contributor to the surrounding InhabitedTime; it allows players to fish while being away from their keyboard (AFK). Players would leave themselves logged in and fishing there overnight hoping for enchantments available only through fishing or trading with non-player Villagers. Contrast this with the Villager Tenements and Trading Grounds in the bottom right of the metropolitan area, which was established much later and relies on trading rather than fishing to acquire these enchantments. Trading requires significantly less time commitment, and therefore has comparatively low Inhabited-Time around it.

This information can be used to inform and evaluate the placement of transport infrastructure. For example, the transport rail in the top of Figure 1 and in Figure 2 is effective since it connects the middle of the metropolitan area and the mob spawner. Meanwhile, the ice-boat bridge on the bottom of Figure 1 may not be so useful, connecting the urban center to a building without much function. Players making new buildings could, however, be encouraged to build near it and give it more purpose.

5 Case study: Multiplayer creative

5.1 Background

Ships and Stuff is a map generated and continuously played on for over 5 years. Unlike *EvanTest*, this world is a creative mode map, meaning that players are invincible and are given unlimited blocks to build with. The only goal is to channel your creativity (hence *creative* mode) and build to your heart's content. On this map, players mostly built starships from the popular sci-fi franchise *Star Trek* (hence "Ships") as well as other miscellany (hence "and Stuff"). Over the years, there

has been a gradual build-up of litter by players. Repeating command blocks, which issue commands that check and modify the game state every tick that they're loaded, run simultaneously and create lag when there are a lot of them. One trend that surfaced while playing on this map was creating traps out of these blocks, which checked for nearby players and annoyed the living daylighters out of them. In order to be effective as traps, they were hidden from view. Years later, when people realized they were causing lag, they were horrendously hard to find because they were buried in places nobody could see. The extent to which this player trend has changed the landscape was unknown, but with the power of GIS, we can find all these pesky blocks and put an end to them once and for all.

5.2 Results

Scanning the four main regions of the map turned up an impressive 295 repeating command blocks littered around the world. See Appendix B, Figure 5 for a plot of all the litter that showed up.

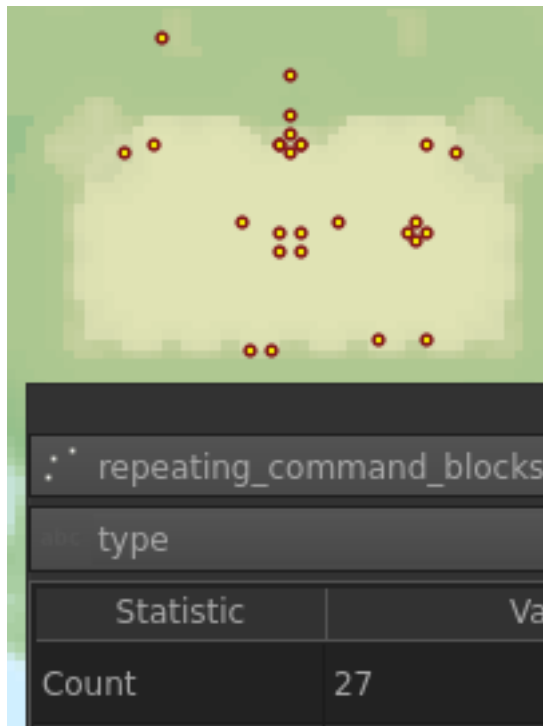

Figure 3: 27 repeating command blocks in this guy's house alone! Naughty, naughty!

5.3 Discussion

Years and years of litter accumulation occurred on the map, despite surface-level cleanups. Hundreds of command blocks were just sitting around constantly doing things, creating lag for players for years. Knowing the

precise locations of all the litter in the area certainly makes it much easier to clean up, which hopefully reduces the lag significantly. If you use GRASS GIS's `v.net.salesman`[5], you can try to make an optimal route visiting all the repeating command blocks in the world to get rid of them. I dub this the "Traveling Minecraft player problem."

Repeating command blocks aren't the only thing you can scan the world for, either. You can scan the world for ores and other resources, if so inclined. Useful for people who don't want to spend time looking for ore. For diamond ore especially, you can skip scanning a ton of blocks by taking advantage of the fact that they spawn at elevations below 16 and in veins that appear only once per chunk. This would save a considerable amount of processing time.

6 Conclusion and future work

All in all, extracting data from Minecraft and into QGIS is a relatively simple and practical procedure. I leveraged existing libraries and bridged the gap between video games and software meant for modeling the real world. It can reveal interesting patterns in where players go and what players do, and aids in creating actionable plans for increasing building visibility and use. It can show the effect of years of play on a map on accumulation of litter and be a tool in cleaning it up at the same time. Plus, it just makes some pretty cool looking maps. I mean, just look at them.

What can be done with GIS software isn't limited to what can be seen here. All the compatible tools that GIS provides is at your disposal. The methods outlined here can also be generalized for other video games. If you can extract the layout of the map, it can be a basemap that provides geographical context for the other data you want to plot.

7 Acknowledgments

A word of thanks to Brian, Evan Grilley (Embry Riddle Aeronautical University), James Akina (Central Washington University), Jack Doughty, Logan Lemieux (Western Washington University), Oliver Low (Georgia Institute of Technology), Tom Connolly (Carnegie Mellon University), and others for playing and building up *EvanTest*. A word of thanks also goes out to Cole Ellis (Oregon State University), James Gale (University of Washington), and Oliver Low (again), and others for playing and building up *Ships and Stuff*. James Gale also requested that I note that he "made all the good ships."

References

- [1] Chunk format — Minecraft wiki. https://minecraft.gamepedia.com/index.php?title=Chunk_format&oldid=1497793. [Online; accessed 14-February-2020].
- [2] Esri Grid format — ArcGIS resource center. <http://help.arcgis.com/en/arcgisdesktop/10.0/help/index.html#//009t0000000w000000>. [Online; accessed 14-February-2020].
- [3] gdal_merge — GDAL documentation. https://gdal.org/programs/gdal_merge.html. [Online; accessed 14-February-2020].
- [4] USGS astrogeology mapping, remote-sensing, cartography, technology, and research (MRCTR) gis lab. "<https://www.usgs.gov/centers/astrogeology-science-center/science/mrctr-gis-lab>". [Online; accessed 14-February-2020].
- [5] v.net.salesman — GRASS GIS 7.6.2dev reference manual. <https://grass.osgeo.org/grass76/manuals/v.net.salesman.html>. [Online; accessed 18-February-2020].
- [6] Simon Egenfeldt-Nielsen, Jonas Heide Smith, and Susana Pajares Tosca. *Understanding Video Games: The Essential Introduction*. Routledge, 2 edition, 2012.
- [7] Fanny von Heland, Pontus Westerberg, and Marcus Nyberg. Using Minecraft as a citizen participation tool in urban design and decision making. *Future of Places, Stockholm*, 2015.

A EvanTest Maps



Figure 4: A part of EvanTest's main region's heightmap with a pseudocolor gradient (cpt-city wiki-2.0) applied.

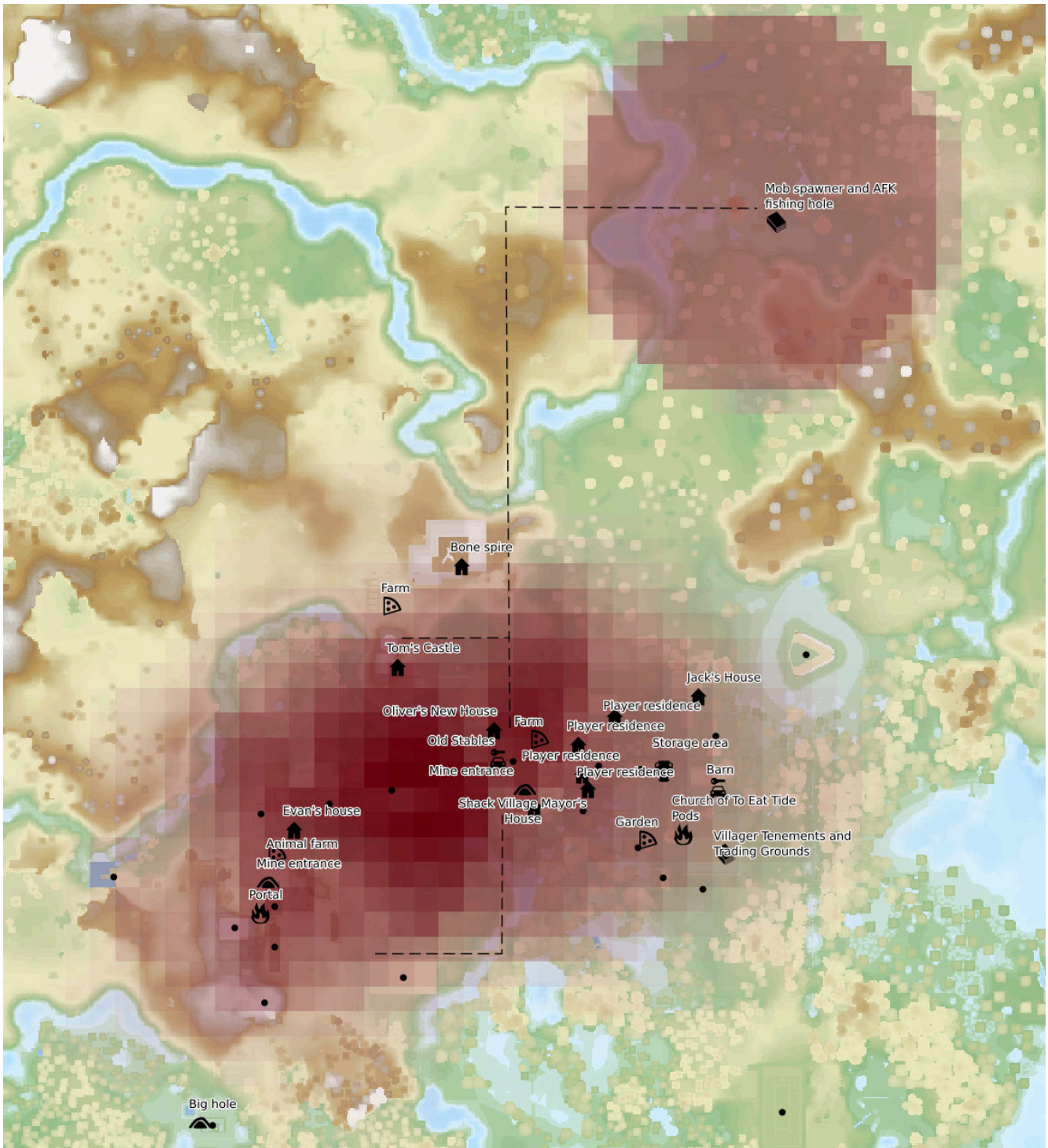

Figure 5: Above map with InhabitedTime map superimposed. The redder, the more inhabited. Labels are also added showing the purpose of buildings below. House icons are player houses, vases are storage areas, cars are storage areas for horses, pizzas are food farms, caves are mines, fires are Nether portals, books are enchanting-related buildings, and dots are miscellaneous. Permanent transportation, like minecart rails, are indicated with dotted lines.

B Ships and Stuff Map



Figure 6: Heightmap of Ships and Stuff with locations of repeating command blocks plotted on top as red dots.

how to git bisect when your test suite is having a bad day

ben blum

bblum@alumni.cmu.edu

abstract

I like probability puzzles but don't know enough stats to actually solve them properly so I threw some thinking sand at it and learned some interesting stuff anyway.

keywords pdflatex, cdflatex

1. problem statement

Let's say you're trying to bisect a given range of n commits.¹ Call them $c_0 \dots c_{n-1}$, where c_0 is known safe and c_n is known to have the bug. You'd probably start by testing $c_{n/2}$, right? And you'd expect to pinpoint the buggy commit in $\log(n)$ steps. That's math.

Ok, but what if the bug reproduces nondeterministically with some probability $p < 1$. You can't even pinpoint the bug at some c_b for sure anymore; you can at best know that it ~proobably~ won't reproduce in any $c_{i < b}$, with some confidence z . Now evaluate your strategy by the expected number of steps to achieve, let's say for tradition's sake, $z > 0.99999$. Is it still optimal to bisect at the midpoint?² What would be a better strategy, as a function of p ?

2. intermission

Put the paper on pause now and think about it. No, really, give it a go! I mean, if you don't think math puzzles like this are cool, just stop reading, no worries. I'm sure there's a paper about, like, hygienic image macros or empire machines or something for you just a few page-turns away.

¹ To use binary search to find a commit that introduced a bug.

² Spoiler: No, or I wouldn't have bothered with this paper.

permission to make digital or hard copies of part or all of this work for personal or classroom use is granted without fee, provided... honestly, provided nothing. the ACH is already flattered enough that you're even reading this notice. copyrights for components of this work owned by others than ACH must be laughed at, then ignored. abstracting with credit is permitted, but abstracting with cash is preferred. and please tip us, for the love of Turing.

sigbovik '20 pittsburgh, PA, USA
copyright © 2020 held by owner/author(s). publication rights licensed to ACH.
ACH...\$13.37

If you're feeling adventurous, implement a strategy and throw it in this simulator I made to see how it fares: <https://github.com/bblum/sigbovik/blob/master/bisect>. You just gotta implement trait BisectStrategy, and it even does all the hard work of applying Bayes's rule for you and letting you see the PDF and everything. Check it out.

3. pdfs, but not the portable document format kind, and our friend rev. bayes

Ok, so let's model the problem as a sequence of steps on a probability distribution function (henceforth, PDF; and also, CDF for the cumulative kind). Initially, $\text{pdf}(i) = 1/n$ for all $0 \leq i < n$. When the bug reproduces at some commit b , you're certain no $c_{i > b}$ introduced the bug, so each $\text{pdf}(i > b) \leftarrow 0$ and each $\text{pdf}(i \leq b)$ renormalizes by a factor of n/b , to preserve the $\sum_i \text{pdf}(i) = 1$ invariant.³

In the deterministic case, $p = 1$, the symmetric thing happens when the test passes at some c_j : $\text{pdf}(i \leq j) \leftarrow 0$. But when $p < 1$, we must generalize it (Vargomax 2007). Here's Bayes's rule:

$$P(A|B) = \frac{P(B|A) \times P(A)}{P(B)}$$

In this case, B is that the test passes at c_j , and A is that bug exists at or before c_j after all. $P(B|A)$ is the false negative rate, i.e. $1 - p$. $P(A)$ is the prior on c_j containing the bug, i.e., $\text{cdf}(j)$. And $P(B)$ is the false negative rate weighted by the bug existing, i.e., $(1 - p)\text{cdf}(j) + 1(1 - \text{cdf}(j))$. To update our priors on commits up to j , we renormalize by dividing out the old $\text{cdf}(j)$ and multiplying by the new $P(A|B)$, i.e.,

$$\forall i \leq j, \text{pdf}'(i) \leftarrow \text{pdf}(i) \frac{1}{\text{cdf}(j)} \frac{(1 - p)\text{cdf}(j)}{(1 - p)\text{cdf}(j) + (1 - \text{cdf}(j))}$$

³ Implemented as fn `adjust_pdf_bug_repros()` in the simulator.

Which simplifies to:

$$\forall i \leq j, \text{pdf}'(i) \leftarrow \text{pdf}(i) \frac{1-p}{1-p\text{cdf}(j)}$$

Call this renormalization factor \mathcal{R} . As a sanity check, $p\text{cdf}(j)$ is less than p , so $\mathcal{R}_{i \leq j} < 1$.

Likewise, for commits above j , we have $P(B|A) = 1$, $P(A) = 1 - \text{cdf}(j)$, and $P(B)$ the same as before. Renormalizing from $1 - \text{cdf}(j)$ this time (and skipping the unsimplified version), we get:

$$\forall i > j, \text{pdf}'(i) \leftarrow \text{pdf}(i) \frac{1}{1-p\text{cdf}(j)}$$

As a sanity check, $p\text{cdf}(j)$ is positive, so $\mathcal{R}_{i > j} > 1$. If you like pen-and-paper algebra, you can also see that $\text{cdf}(j)\mathcal{R}_{i \leq j} + (1 - \text{cdf}(j))\mathcal{R}_{i > j} = 1$.⁴

Let's do a nice concrete example. Say $n = 16$, the test passes at $j = 7$, and then fails at $j = 11$. In the deterministic case, all the probability mass will be concentrated uniformly in the range $[8, 11]$. However, if the bug repros only half the time, $\mathcal{R}_{i \leq 7} = 2/3$ and $\mathcal{R}_{i > 7} = 4/3$, and we get probability mass scattered all the way down to c_0 , as shown in [figure 1\(a\)](#). Yuck, someone clean that up!

Now let's say the test passes at $j = 9$, then at $j = 10$. [figure 1\(b\)](#) shows the updated PDFs/CDFs: for $p = 1$, this pinpoints the bug at $j = 11$, and the search is over. But for $p = 0.5$, there's still 2/3 odds we'd be wrong! In fact, from here it takes 18 further probes at $j = 10$ until we are at least five 9's confident that c_{11} is the culprit.⁵ Bayes's rule gonna get ya.

A noteworthy invariant here is that the PDF is always monotonically nondecreasing in its nonzero range: each passing test always shifts probability mass to the right of the bisect point, but past the earliest known bug repro, nothing can ever revive it back above 0.

4. prior work

I was kinda surprised to find no existing mathy solution to this problem lying around on the online. Wikipedia has a brief little subsection on "noisy binary search", which links a few papers older than I am. In one ([Rivest et al. 1980](#)), they bound the number of erroneous answers by a fixed factor of the

⁴Implemented as `fn adjust_pdf_no_repro()` in the simulator.

⁵See `fn test_figure_1()`.

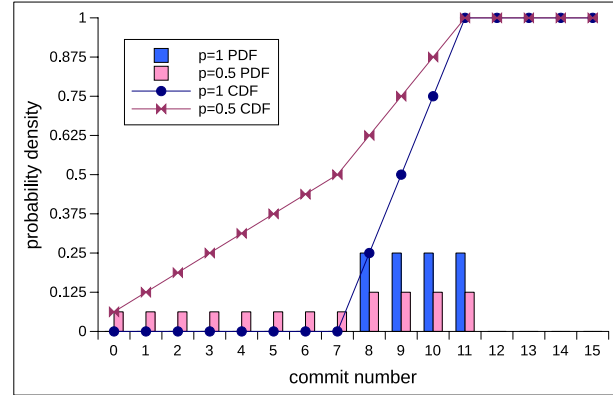

(a) after two tests

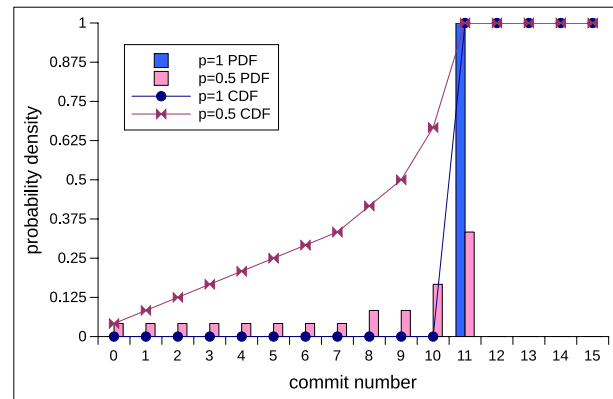

(b) after "classical" search terminates

figure 1. example {,non}deterministic {P,C}DFs

number of queries, so it's more like "twenty questions with lies" than bisect. In another ([Pelc 1989](#)), they do fix the error rate p , but they allow for symmetric false negatives and false positives, both with the same p . This too changes the nature of the problem; notably, if $p = 0.5$, you can't make any progress whatsoever.

Dropbox has a CI service called Athena ([Shah 2019](#)) which automatically searches for flaky tests. In this case the goal is to keep the build green, but if you consider the flaky test itself to be the bug, it's the same problem.⁶ Athena "deflakes" the test at each commit by running it 10 times, treating the combined result as "basically as good as $p = 1$ ", and then runs an otherwise classical binary search. In this setting, p is not known in advance, so using Bayes's rule

⁶Incidentally, the symmetric case – where a bug repros with $p = 1$, but the test also flakes with some $q < 1$ – is also the same problem.

is off the table. But I will show that even without access to the PDF, a better strategy exists.

5. strategies

Ok, so how do we make progress, i.e., concentrate probability mass til there's z of it in one place, as quickly as possible? Let's deconstruct the motives of classical binary search. Let c_b denote the earliest known buggy commit, and c_a be the latest known safe commit. In Determinism World, bisecting at $c_{(a+b)/2}$ minimizes the worst case maximum range remaining, as the two possible outcome ranges are the same length. But in Nondeterminism World, a doesn't ever budge from 0, so bisecting at $c_{(0+b)/2}$ will not even terminate. Sure, hitting the PDF with $\mathcal{R}_{b/2}$ will always move *some* mass rightward, but once five 9's of it is already over there, it can't concentrate it onto one point. So let's not think about the range.

5.1 bisect probability mass

Another way to frame it is that the $c_{(a+b)/2}$ bisect point cuts the probability mass, rather than the range, in half, i.e., $\max_j(j; \text{cdf}(j) \leq 0.5)$. This approach fits the "binary search" spirit, and will also terminate in Nondeterminism World: if b is the solution, it converges to repeatedly probing $b - 1$, so it can pass any fixed z threshold. But is 0.5 still the best bisect point even when $p < 1$? I wondered if this could be expressed as the amount of probability mass moved from one side to the other, i.e., $\sum_i \text{abs}(\text{pdf}(i) - \text{pdf}'(i))$. In the case where the bug repros this is:

$$p \text{cdf}(j) \times (1 - \text{cdf}(j))$$

and in the case where the test passes:

$$(1 - p \text{cdf}(j)) \times \text{cdf}(j) \times (1 - \mathcal{R}_{i \leq j})$$

which, surprisingly, simplifies to exactly the same thing as the bug repros case. The maximum occurs where $\partial / \partial \text{cdf}(j)$ is 0, which turns out to be at $\text{cdf}(j) = 0.5$ after all, and independent of p .⁷ But it's not clear that the amount of mass moved necessarily corresponds to reaching z the fastest. I show my work in [figure 2](#), because that's what they taught me to do in high school algebra class.

⁷I also worked out the *minimum* moved mass between the pass and fail case, which is almost always the pass case. It comes out to $\frac{\text{cdf}(j)(1-\text{cdf}(j))}{1/p-\text{cdf}(j)}$, which experiences its maximum at $\frac{1-\sqrt{1-p}}{p}$ (thanks wolframalpha). But this is worst-case thinking, which doesn't seem appropriate. Let's have some optimism!

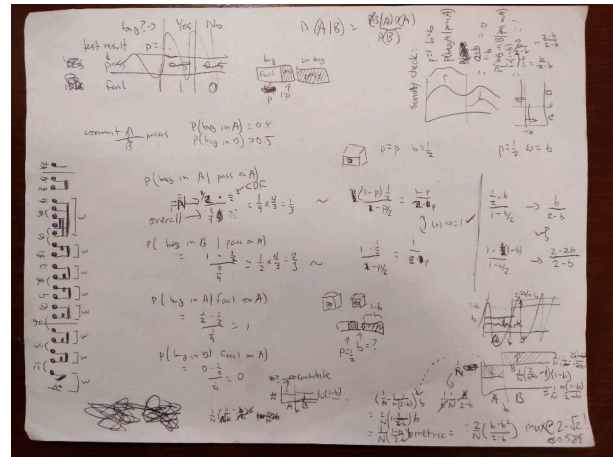

figure 2. derivation(?) of optimal(?) bisect point

5.2 bisect entropy

A PDF's information content is measured in entropy: $\mathcal{H} = \sum_i \text{pdf}(i) \ln(\text{pdf}(i))$. Alone, this value is fairly meaningless, but to compare them, a spikier PDF has lower entropy than a flatter one. Indeed, when the search terminates in Determinism World, $\mathcal{H} = 0$. I thought for a while about how to link "minimum expected entropy" to the stated goal of $z = \max_i(\text{pdf}(i)) > 0.99999$, but couldn't really formalize the idea. The goal of five 9's is fairly arbitrary anyway, and also not necessarily stable under the entropy measurement, since it doesn't care how the remaining 0.00001 is distributed.⁸

This strategy is expensive to compute. Whereas bisecting at some fixed threshold of probability mass merely requires a $O(\log n)$ query of the CDF, computing the expected entropy is $O(n)$ for *each* bisect point. A Very Smart Math Friend of mine ([Gorey 2009](#)) analyzed the easy case of the initial test, when the PDF is still uniform (i.e., $\forall i, \text{cdf}(i) = i$), and found the closed form:

$$\mathcal{H}_{0,j} = p \ln(j) + (1-p) \ln(1-pj) - j(1-p) \ln(j-p)$$

whose derivative, in his words, "looks like a giant mess that does not admit an analytic solution for j ."

There is a ray of hope, however: thanks to the nondecreasing-PDF invariant I mentioned in [section 3](#), the expected entropy has a unique local minimum.⁹ Thus we can binary search for the global

⁸See fn test_entropy_stability().

⁹See fn test_expected_entropy_has_unique_local_minimum().

minimum, making this at worst $O(n \log n)$ instead of $O(n^2)$.

5.3 bisect randomly

Maybe a random world calls for a random algorithm! It's obvious this will terminate, but of course it won't be fast. Intuitively, if we use the PDF to weight the random choice, it will be faster than choosing uniformly in $[0, b)$. But how much faster?

You can tell at this point I'm starting to get statistics fatigue. Not unprecedented in these hallowed proceedings (Wise 2017).

5.4 human

Humans are known to be less patient than computers (citation: section 5.3). If a human is unwilling to compute $\mathcal{R} \circ \text{pdf}$ by hand every step, or, more prohibitively, simply doesn't know p in advance so can't compute \mathcal{R} at all, what should they do? Let's say a "human strategy" is any that doesn't use the PDF/CDF when deciding where to bisect.¹⁰

The most straightforward thing for a human to do is to assume $p = 1$ until they encounter evidence to the contrary. They'll conduct a normal binary search, and when they think they've found the bug at c_b , they'll just keep probing c_{b-1} until enough probability mass (invisible to them) moves to b and the simulator says they can stop. If this instead repros the bug at c_{b-1} after all, the human gets confused! They'll assume the bug might have been present as early as c_0 , forgets their lower bound, and begins binary searching anew in the range $[0, b)$. It's easy to see this makes progress. Let's call this the "confused, forgetful human" strategy.

Another confused human variant is for them to remember their previous lower bounds. After all, just because their best lower bound $b - 1$ was contradicted doesn't say anything about some earlier bound $a < b - 1$ they might have observed. So this human will maintain a stack of lower bounds, and when $b - 1$ is contradicted, they'll pop off the stack and resume searching in $[a, b)$ instead. Let's call this the "confused human who remembers". Incidentally, while implementing this strategy, I accidentally wrote the comment,

¹⁰ In fact rand-uniform from last section counts as a human strategy. Did you bring your dice?

```
// the human, who now has perfect memory,  
// walks backwards in time
```

and giggled a lot to myself as I imagined sigbovik fan-fiction.

Finally, let's imagine the human knows in advance that maybe something is up with this p stuff. Wanting to carry on classically as though p were 1, they'll try to emulate p being higher by retrying any passing test "just to be sure", before moving on. If they retry the test r times, the probability it fails given the bug is present is then $1 - (1 - p)^{1+r}$. But it comes at the cost of r more steps for each new lower bound! As before, when this human thinks they're done, they'll repeatedly probe c_{b-1} until contradicted (and we'll make them forgetful, to keep things simple). Let's call this the "suspicious human of r retries".

6. simulated it

At this point I threw in the towel on the maths front, and wrote a bunch of code to let the law of large numbers do my work for me.

To save you some page-turning, here's the source code link again: <https://github.com/bblum/sigbovik/blob/master/bisect>. A BisectStrategy implements a function over p , the PDF, and/or its own internal state to choose the next bisect point. The SimulationState is initialized with fixed n and p , and repeatedly invokes a given BisectStrategy, hitting the PDF with Bayes's rule accordingly, until $z > 0.99999$. I provide implementations for all section 5's strategies in `src/strategies/`. It's written in Rust so it's self-documenting.

I learned a lot about floating point. I don't mean like NaNs and mantissa bits, I mean that when your project is fundamentally a long multiplication chain of increasingly high rationals, your precious $\text{cdf}(n)$ inevitably drifts farther from 1 than you can bound with any arbitrary ϵ , and you start drowning in imprecision (Shiranu 2071). I suppose I could have used the BigRational library, but I chose Rust over Haskell for this so I could *avoid* runaway memory consumption... so, I resigned myself to explicitly renormalizing my PDFs by $1/\text{cdf}(n)$ each time I updated them. After that, I was able to write some assertions to bound the imprecision drift within $k(\text{std}::\text{f64}::\text{EPSILON})$ (VII 2014). But yeah, I definitely spent some sanity points writing a function named `fn assert_kind_a_equals_one(&self)`.

7. experiments

Let’s get right to the good stuff. [figure 3](#) shows the overall results, plotting the average performance of each of the strategies from [section 5](#).

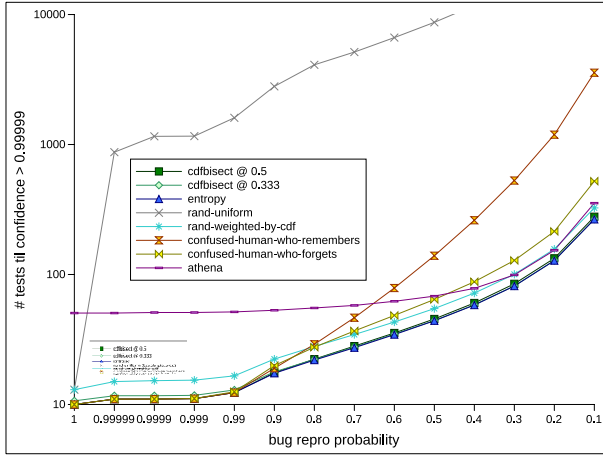

(a) full view

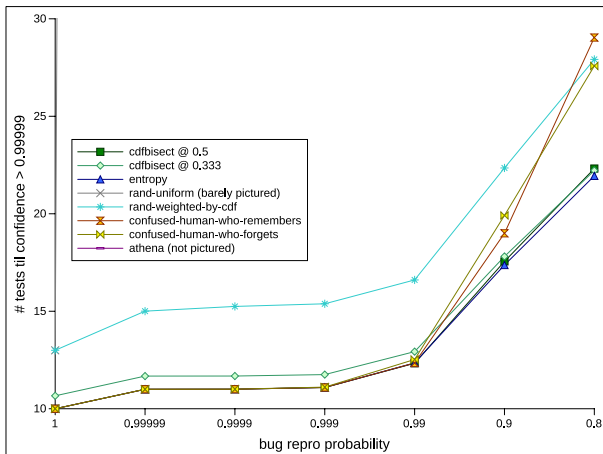

(b) detail view of high p range; linear scale

figure 3. perf results. how many bisect steps each strategy takes to reach five 9s of confidence

Each data point is simulated with $n = 1024$ and averaged over 65536 trials. I chose a power of two for n to minimize floating point drift (handwave), and a multiple of n for trials so that `buggy_commit = trial % n` would be uniform.

Of course, each trial takes exponentially longer and longer as $p \rightarrow 0$, so I didn’t bother testing past 0.1. I also didn’t bother measuring execution time, as prior work has shown that one’s personal laptop is a fraught environment for stable performance evaluation ([Blum 2018](#)), but it was still very obvious that en-

trophy was far, far slower per step than all other strategies. It was even slower than rand-uniform!

7.1 computer strategies

Minimizing expected entropy turned out to be the best strategy, globally across all p . Bisecting probability mass turns out to be preetty close, although its performance varies depending on its bisect-point parameter j . Obviously, when $p = 1$, j should be 0.5 to reproduce classical binary search, but at around $p = 0.8$, $j = 0.333$ overtakes it. Ultimately at $p = 0.1$, the former is about 4% slower compared to the latter and to entropy, contradicting the “independent of p ” hypothesis from [section 5.1](#). I investigated a little more to see how p affected the optimal j , testing various j s in increments of 0.01:

p	best j	cdfbisect(j)
1.0	0.50	10
0.9	0.45	17.4
0.8	0.41	21.9
0.7	0.39	27.5
0.6	0.40	34.6
0.5	0.36	44.1
0.4	0.35	58.3
0.3	0.34	81.6
0.2	0.36	127.9
0.1	0.35	266.6

65536 trials here wasn’t really enough to get variance under control, but it definitely seems to converge towards 0.333 or maybe 0.35 or something as $p \rightarrow 0$. Open question why for warp zone, I guess.

rand-uniform is obviously terrible but I threw it in there for kicks. rand-cdf is not so terrible, doing even better than all the human strategies.

7.2 human strategies

I investigated how the suspicious human’s number-of-retries parameter r affects their performance. In this notation, $r = 1$ means they retry once whenever the test passes, meaning two test runs on every passing commit. $r = 0$ is equivalent to the forgetful strategy, and $r = 9$ is what Athena does ([section 4](#)).

[figure 3](#) was getting a little crowded so I’ve plotted all the human-friendly strategies separately on [figure 4](#). It’s pretty self-explanatory imo.

One thing that surprised me was that the human who forgets all their past known lower bounds when any of them is contradicted performed better than

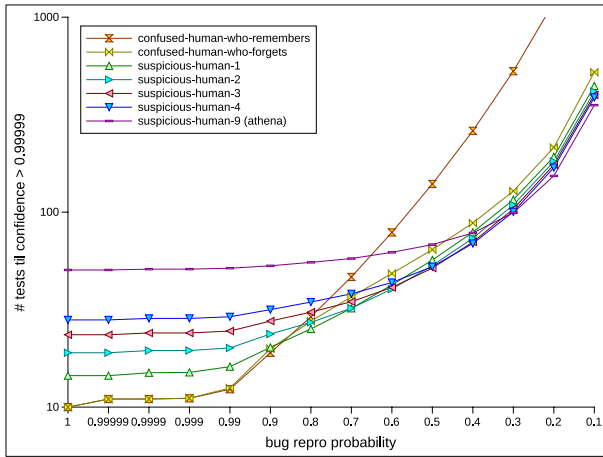

figure 4. version of figure 3 for human strategies

the human who tried to rewind to their last not-yet-contradicted lower bound. I guess there's a moral here about not clinging to the past, moving on with life, or something.

7.3 why five 9s?

Let's talk about the arbitrary confidence threshold. There's a lot of knobs to tweak here and only so much time til April 1 (not to mention reader patience), but I did at least want to show what happens if you terminate the search when you're only 50% confident. Compared to figure 3, the strategies all terminate in about half as many steps, with the same relative ranking and break-even points. What's more interesting is the number of times they were wrong.

I had the simulator refuse to count a wrong result, restarting the search until it correctly identified the buggy commit 65536 times, and counting the number of restarts. With $z > 0.99999$ this was not very interesting: the strategies collectively made 0 errors 81% of the time, and were wrong more than twice only 0.6%. But $z > 0.5$ is a different story. As figure 5 shows, most strategies – even the comically slow rand-uniform – converged to being wrong about half the time, i.e., 65536 wrongs per 65536 rights. For higher p , athena was most resilient.

confused-human-who-remembers, alone, did not converge. They became more and more unable to cope with the repro rate approaching 0, ultimately being wrong 8 times as often as they were right. Oh, human... please learn to let go and love yourself for who you are. There's a better world out there, a sparkling radiant future waiting just for you!

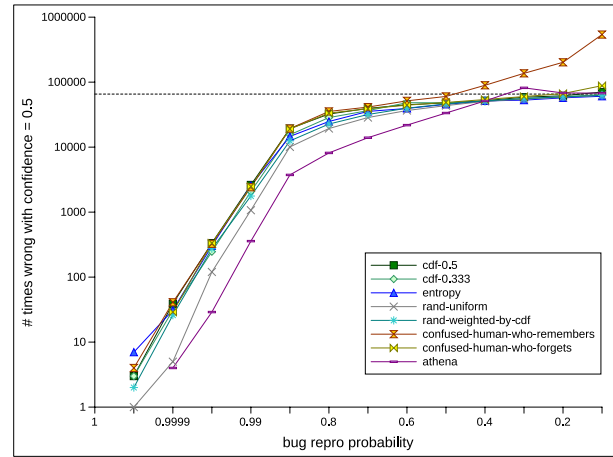

figure 5. how often each strategy was wrong, when terminating with only 50% confidence. the dashed line marks the approximate convergence point at 65536, equal to the number of right answers

8. future work

I'm not ashamed to admit I left a lot of loose ends in this paper. The biggest open questions for me are:

1. What relates p to cdfbisect's optimal argument?
2. Why is entropy *so tantalizingly close* to cdfbisect? Is there some way to show they're the same?

I have also prepared a set of backup questions in case those aren't enough for you:

4. If you don't know p in advance, is there an efficient way to multiplex the search with figuring it out on the fly?
5. What if false positives are also possible, with some flake rate $q \neq p$?
6. What if the cost of git checkout is nonzero (e.g., having to recompile your tests on new code)? Clearly human-mistrustful becomes better. What about some wacky hybrid cdfbisect-mistrustful?

7. conclusion

If you are a computer, you can do pretty well by bisecting the probability mass somewhere between 1/3 and 1/2. If you are a human, you should forget everything you know as soon as you see new evidence that contradicts your priors.

And remember to be patient and kind. Your test suite is just trying its best!

acknowledgments

Thanks to Jason Reed, Lynn Chordbug, and Sujay Jayakar for thinking about this problem with me.

referents

- B. Blum. Transactional memory concurrency verification with Landslide. *sigbovik* 12, 2018.
- K. E. Gorey. A categorical primer. *sigbovik* 3, 2009.
- A. Pelc. Searching with known error probability. *Theoretical Computer Science* 63, 1989.
- R. Rivest, A. Meyer, D. Kleitman, K. Winklmann, and J. Spencer. Coping with errors in binary search procedures. *Journal of Computer and System Sciences* 20, 1980.
- U. Shah. Athena: Our automated build health management system. *Dropbox.Tech blog*, 2019.
- N. Shiranu. IEEE 755: Drowning point numbers. *sigbovik* 65, 2071.
- V. V. Vargomax. Generalized super mario bros. is NP-complete. *sigbovik* 1, 2007.
- T. VII. What, if anything, is epsilon? *sigbovik* 8, 2014.
- J. A. Wise. Batch normalization for improved DNN performance, my ass. *sigbovik* 11, 2017.

Blockchain Gang

31 RegisToken

Irene Lin, Arnaud Avondet, Preston Vander Vos

Keywords: blockchain, Ethereum, token, FCE, course registration

RegisToken

Irene Lin Arnaud Avondet Preston Vander Vos
Trevor Leong Ishgun Arora Edward Li

Carnegie Mellon University

{iwl,aavondet,pvanderv,tmleong,isarora,edwardli}@andrew.cmu.edu

Abstract

This paper identifies two problems at Carnegie Mellon University: low Faculty Course Evaluation (FCE) survey response rates and the student course registration bottleneck. We propose a solution to both via a state-of-the-art token, RegisToken, on the Ethereum blockchain. Students receive tokens by filling out FCEs and spend tokens to register for additional classes.

Keywords— Blockchain, Ethereum, Token, FCE, Course Registration

1 Introduction

Faculty Course Evaluation survey response rates vary greatly, but not many are great. This is alarming because advisors and students use FCEs to gauge the workload and intensity of a course. However, we see that incentivization to fill out FCEs is a consistently reliable strategy. Our goal is to leverage this strategy to solve another problem in the course registration system. Students are assigned time slots throughout the day for when to register. This causes students with earlier time slots to sign up for many courses, intending to drop them later. As a result, students with later time slots are left scrambling for less convenient recitation times or placing themselves on multiple waitlists.

Our solution to the course registration bottleneck is to deploy a smart contract that tokenizes additional registration units. Students are still allowed to freely register for a baseline number of units, but if they want to sign up for additional units, they must pay using tokens. Tokens are received through filling out FCEs. This incentive is equivalent to the rewards that some courses use for encouraging students to fill out FCEs. Then, students spend tokens on registration units. The number of tokens required for additional units depends on the time of the day. The registration bottleneck is alleviated because students must spend more tokens per unit earlier in the day compared to later in the day. This smart contract is deployed on the Ethereum blockchain.

2 Background

This section discusses the problem space regarding low response rates for faculty course evaluations and the course registration bottleneck. This section also gives an introduction to Ethereum, the distributed technology that our solution is built upon.

2.1 Faculty Course Evaluations Low Response Rate

Course Evaluations (FCEs) are simply surveys conducted at the end of a semester on the performance of an instructor and the class in general[5]. FCEs are used to improve the quality of teaching and learning at Carnegie Mellon through feedback to both individual faculty members and promotion committees. Responses to the FCE provide information on students' perceptions of their engagement, learning outcomes, the instructor's behavior, and course activities. This feedback helps guide changes in future iterations of the course and/or the instructor's teaching (The Hub, CMU).

The validity of this data revolves around the number of students who complete the FCEs. In a perfect scenario, all students would fill out the survey and the academic department would get an accurate response of students' opinions. However, in practice only a small portion of the class size fills out the surveys, with mild variations in each class. For instance, course 99-101 (Computing @ Carnegie Mellon), a staple course of the Carnegie Mellon curriculum, received only a 35% response rate in Fall 2019. This is simply unacceptable. In similar light, course 57-403 (Yoga for Musicians) received a 16% response rate in the same semester. To take in account a response rate from the higher end of the spectrum is course 79-353 (Imprisoning Kids: Legal, Historical, and Moral Perspectives) taught by professor Katherine Lynch received 60% response rate in Fall, which isn't great either. On the other hand, 18-240 (Structure and Design of Digital Systems) consistently has a 95 to 100% across semesters because the last graded homework assignment in each semester is filling out the FCE. And 85-241 (Social Psychology) taught by Professor Manke has a 97 to 100% response rate because he awards a bonus point to the entire class if the total FCE response rate is above some threshold.

These poor response rates result in low accuracy of the data collected. On average, if only half the class fills out the survey, their opinions can not be considered to be a full representation of the entire class and hence, cannot be used to implement any changes in the course. Secondly, when there is no incentive to fill out the surveys, the students who actually undertake the responsibility to complete these are biased in their response - they're either extremely satisfied with the class and will rate it positively or are completing the survey to express resentment/request for alterations to the course. This does not provide a true picture of the students' opinions and may result in inaccurate ratings of professors and courses,

which can't be generalized for the entire class.

2.2 Course Registration Bottleneck

Course Registration is one of the most stressful times of the school year for students at Carnegie Mellon, and has been a point of contention for generations of students, and even more now with the release of the superior life-planning tool, Stellic. The process begins when a student is faced with the choices of classes that he/she will take in the next semester. While many of the courses required for one's major have seat reservations, it does not fix the problem of obtaining classes that one is interested in, but is not majoring in. In an ideal world, this would not be a major problem, as each student would only register for classes he/she would actually take. Due to the competitive nature of course registration however, students are incentivized to sign up for excess classes and drop them during the semester when they are disappointed/unable to achieve their desired grade. As a result, students with earlier registration times are consistently overloading, leaving those with later times stuck in the purgatory of the wait list.

The problem is not easily remedied, and there does not appear to be any easily implementable solutions. On first glance, it would be easiest to simply randomize classes completely, giving each student an equal number of credits, which would fix the problem of advantageous registration times. This solution is near perfect, if only there was the edge case of the fact that some students would theoretically never graduate. Another possible, yet extremely flawed solution would be to have a class lottery system, where students are given equal footing in every class, and selection is based on random chance. This solution is also not viable, as students would not be given enough time to plan for back up classes.

2.2.1 Ethereum Introduction

Ethereum is the second largest cryptocurrency by market cap. It is different than Bitcoin; Ethereum aims at being the world's computer. Bitcoin, made by the modern-day genius Craig Wright, is pretty much only used for transactional purposes. People simply send BTC back and forth. Ethereum allows people to write smart contracts. Smart contracts are written in a Turing complete language: Solidity. Anyone who is willing to pay for their code to be in the network, can write a smart contract. The Ethereum Virtual Machine (EVM) will run the code when requested. Every node in the network will run the smart contract on the EVM when it is requested. This way, all nodes maintain the same state of the network throughout the various execution calls.[6][7][8]

Smart contracts are used today for everything. DApps (decentralized applications) are becoming extremely prevalent. DeFi (decentralized finance) is at the forefront of DApp developments. Ethereum is giving people and companies the ability to build DApps which are replicating the "standard"

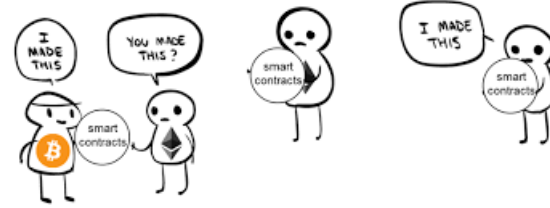

Figure 1: Developers write smart contracts that run on the Ethereum Blockchain.



Figure 2: Picture of a real life blockchain.

financial products. This is simply one use case of smart contracts.

ERC20 tokens are also a fascinating feature of Ethereum. This is a token standard which allows people to make their own tokens in the Ethereum system. These tokens can be created and interacted with via smart contracts. ERC20 tokens are very customizable, allowing people to create them for the use case of their choosing[4]. We will be utilizing the ERC20 token in our solution.

3 Proposed Solution

Before we present our solution to the detrimental problem that education here at Carnegie Mellon University faces, we will try to reduce it to a simpler problem we observe in our everyday lives: appreciation for free food. Picture yourself as an undergraduate freshmen at humble Carnegie Mellon University during your first semester. A stream of companies come to campus to convince you that their company offers the best software engineering internship in the world, and to convince you, they offer you pizza. It is common knowledge that every high school student appreciates pizza to its fullest extent, but what about after getting showered with free pizza for weeks? Figure 3 shows that the affect is quite evident: receiving pizza for free decreases students' appreciation for it. Given this observation, we can state the following theorem.

Theorem 1 *The Recruitment Week Pizza Problem is isomorphic to the Registration Problem.*

This fact is actually quite simple to see, and the proof is left as an exercise for the reader.

Now that we explained the motivation behind our solution, we propose a system that discourages students from registering for many units by requiring students to fill out



Figure 3: Pie chart depicting appreciation for Pizza of first year students after recruitment season (2020)

FCEs in order to register for additional units on top of a normal course load. The student is issued tokens proportional to the number of units for the FCEs completed. The student transfers tokens back to the system in order to register for additional units. The token price of registering for additional units is proportional to the number of total units the students desires to register for. This means that the number of tokens required to add 15 more units is much greater than the number of tokens required to add 3 more units. The token price is also inversely proportional to the time of day, meaning that registering for more units at 8am requires more tokens than at 4pm.

When the student fills out an FCE, they pass in a public address to wallet on the Ethereum blockchain. The Administrator wallet will transfer tokens to the student using the `issueTokens` function.¹ This function takes in the student wallet address to send funds to and the number of units for the FCE the student filled out. The number of units is converted to number of tokens awarded to the student according to some scalar constant value passed into the constructor. If the transfer fails, then the Administrator wallet issues an IOU to the student through the `approve()` function. Then, at some later time, the student can redeem their tokens.

When students register for classes, they have some hard unit cap they are not allowed to exceed. We propose the idea of a soft unit cap that students are discouraged from exceeding, but are allowed to exceed through filling out FCEs. For demonstration purposes, let the soft unit cap be 36 units because this is the minimum number of units a student must register for in order to be considered a full-time student. But in reality, this soft unit cap can be set by administration to whatever value. Suppose a student registers for 36 units and desires to register for an additional 12 unit course. SIO will show how many tokens are needed to register for 12 more units based on the time of day. The student must transfer that amount of tokens back to the Administrator wallet by calling the `transferToOwner()` function and provide proof by submitting transaction hashes to SIO. SIO will check that the transactions took place within the current registration period.

¹All code is provided at the end of this paper.

Suppose the student has now successfully registered for 48 units (12 units above to soft unit cap) and desires to register for another 3 unit mini. SIO will calculate the token price for those 3 units based on the time of day and the number of units over the soft unit cap the student has already registered for.

3.1 Hyperparameters

This section covers system hyperparameters that administration is allowed to set.

FCE Unit to Token Conversion Rate. When a student fills out an FCE, they receive some number of tokens in exchange. In the `RegisToken` smart contract, the number of units is multiplied by a scalar in line 45 of the `issueTokens` function. This scalar is a state variable that is set in line 30 of the constructor. It is recommended to set this value to a large number in order to allow for greater granularity for calculating the token price for registering for additional units. But if the number is too large, then the contract will run out of tokens.

Total Token Supply. The Administrator wallet is allowed to set the total token supply when the smart contract is deployed. We recommend setting the total supply to a very large number. Using engineer's induction, we can easily prove that Carnegie Mellon will be around for at least the next 1000 years, so keeping that in mind would be helpful in setting an appropriate total supply. If the token supply runs out, the Administrator wallet can deploy another token contract and configure SIO to accept transaction hashes that point to valid token transfer transactions of from both contracts.

3.2 FCE System Changes

In order for this system to work, there needs to be an administrative wallet that deploys the `RegisToken` smart contract and becomes the owner of the smart contract. This address must be used to call the `issueTokens` function when a student completes an FCE. This can be done by changing the FCE to take in a student wallet address as a parameter and using Infura for easy and scalable API access to the Ethereum network.

3.3 SIO System Changes

SIO must compute the token price for units as a function of number of units over soft cap and time of day (discussed in next section). The student must register a wallet address in SIO under Student Information. When a student registers for classes on SIO, SIO must accept transaction hashes and verify that transaction hashes point to valid transactions and that the following are true:

- Transactions were mined within this registration period. Students are not allowed to double count transactions from previous semesters.

- Transactions called the transferToOwner function and the token values in each transaction sum to greater than or equal to the token price for the desired number of units the student is registering for.
- Transaction origins match the registered student wallet address registered in SIO. Students are not allowed to steal transactions with calls to transferToOwner from other wallets and must use a single wallet.

The system maintains pseudonymity and does not leak student information because no course information is published when the contract issues tokens for completed FCEs. Because this information is kept off chain, course schedules cannot be linked to student wallet addresses.

3.4 Token Price per Unit

Through months of game theoretic and economic research, we have come up with the optimal formula to compute the tokens per unit conversion rate at any given time.

Theorem 2 Let η = days left in the registration week, λ = hours left in the day, and ξ = total number of units above the soft cap.

The number of tokens/unit, τ , can be expressed as the following.

$$\tau = \frac{(\eta\lambda)^2(\xi^2\lambda^3)}{(\lambda^2)^2\eta\xi}$$

The total number of units above soft cap is the number of units for the class the student is trying to register for plus the total number of units the student has already successfully registered for. The number of hours left in the day starts counting at 8AM and stops after 5PM. The number of days left in registration week starts on the Monday of registration day and stops after all freshmen have registered on Thursday. Outside of valid registration time slots, the token price for adding units is zero. Only students who have already registered are allowed to add more classes without transferring tokens. If a student with junior standing registers on 8am on Tuesday, the earliest time they can add classes for free is after the rest of the students in the junior class have registered. Otherwise if the student desires to register for more units than the soft unit cap allows at 8am, then they must transfer tokens. Placing oneself on a waitlist also requires tokens if it is during valid registration time slots.

3.5 Token Balances for First Year Students

There is no default action taken to give tokens to first year students before they start the academic year. However, the design allows the Administrator wallet to issue tokens to first year students if desirable. However, the registration system will not break if first year students start with zero token balance. If a first year student desires to register for units above the soft unit cap, the token price is zero after first year registration day.

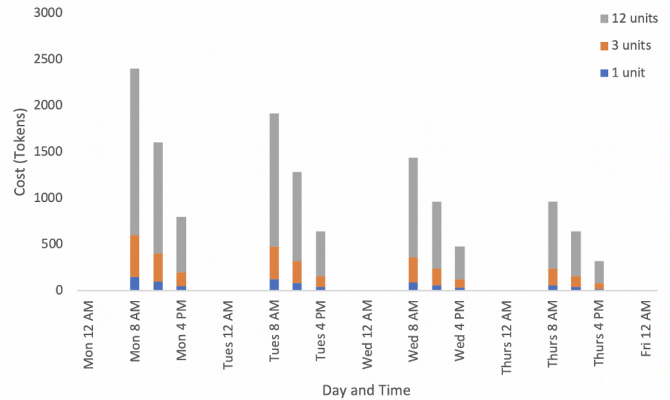

Figure 4: Token price for registering for additional units over the soft unit cap.



Figure 5: An example of a CryptoKitty.

4 Related Work

Tokens are extremely useful. Take Dogecoin for example [3]. Shiba Inus everywhere love Dogecoin [2]. It has become such a fun and friendly community. None of this would have happened if it was not for the token in the middle of the community. The token has brought out many smiles.

The most prominent example of an ERC20 token is CryptoKitties [1]. Cat lovers everywhere love CryptoKitties. Users are able to breed, play with, and collect kitties. There are rare, very collectible, kitties which people seek after. There is a lot of interaction with the token as people trade them. The token has spurred a community of cat lovers to action and joy. Tokens truly solve many problems and bring much happiness.

5 Conclusion

Future work includes research on the economy of token trading among students. When students graduate from CMU, they are unable to spend their tokens on registration units, so it is in their best interest to sell to underclassmen. Will this cause the token value to crash? Another area of research is extending this into an anonymous reputation system that rewards student wallet addresses for consistently filling out FCEs virtuously. The verification and incentivization models are complex and worthy of investigation.

In this paper, we have investigated the problem space regarding low Faculty Course Evaluation survey response rates and the course registration bottleneck. We designed a smart contract of tokenized registration units in order to solve both problems. The smart contract preserves pseudonymity of the student and maintains minimal state. We discuss the changes that need to be made off chain and how that interfaces with the smart contract. The token system alleviates the registration bottleneck by requiring more tokens per registration unit if it is earlier in the day and registration week, and requiring little to zero tokens if it is later in the day and registration week. This system is parameterizable can be made backward compatible.

References

- [1] Cryptokitties. <https://www.cryptokitties.co/> Accessed: 2020-2-24.
- [2] Doge meme. <https://knowyourmeme.com/memes/doge> Accessed: 2020-2-24.
- [3] Dogecoin. <https://dogecoin.com/> Accessed: 2020-2-24.
- [4] Erc20. <https://en.bitcoinwiki.org/wiki/ERC20> Accessed: 2020-2-21.
- [5] Faculty course evaluations (fces). Accessed: 2020-2-20.
- [6] What is ethereum? <https://ethereum.org/what-is-ethereum/> Accessed: 2020-2-21.
- [7] V. Buterin. A next-generation smart contract and decentralized application platform. <https://github.com/ethereum/wiki/wiki/White-Paper> Accessed: 2020-2-21.
- [8] V. Buterin. @vitalikbuterin. <https://twitter.com/VitalikButerin> Accessed: 2020-2-24.

6 Appendix: Code

```
1 pragma solidity >=0.6.0;
2
3 contract RegisToken {
4
5     // track address of owner
6     address payable public owner;
7     // constant for token multiplier value
8     uint TOKEN_SCALAR;
9
10    // ERC20 state variables
11    string public constant name = "RegisToken";
12    string public constant symbol = "RGT";
13    uint8 public constant decimals = 18;
14
15    // Keep track of data needed for ERC20 functions
16    mapping (address => uint256) public balances;
17    mapping(address => mapping (address => uint256)) public allowed;
18    uint256 public _totalSupply;
19
20    // Throws if called by any account other than the owner.
21    modifier ownerOnly() {
22        require(msg.sender == owner, "Caller is not the owner");
23        _;
24    }
25
26    // @param _token_scalar The multiplier from FCE units to tokens
27    // @param _total_supply The total supply of tokens
28    constructor(uint _token_scalar, uint _total_supply) public {
29        owner = msg.sender;
30        TOKEN_SCALAR = _token_scalar;
31        // owner starts with all the tokens
32        balances[owner] = _total_supply;
33        _totalSupply = _total_supply;
34    }
35
36    //-----
37    // Owner Only Functions
38    //-----
39
40    // @brief Issue tokens to student by transferring funds to student.
41    // If transfer fails, give an IOU to the student
42    // @param _student Student address
43    // @param num_units Number of units for the fce filled out
44    function issueTokens(address _student, uint num_units) public ownerOnly {
45        uint num_tokens = num_units * TOKEN_SCALAR;
46        if (!transfer(_student, num_tokens)) {
47            uint total_owed = num_tokens + allowed[owner][_student];
48            approve(_student, total_owed);
49        }
50    }
51
52    //-----
53    // ERC20 Functions
54    //-----
55
```

```

56 // Total number of tokens in circulation
57 function totalSupply() public view returns (uint) {
58     return _totalSupply - balances[address(0)];
59 }
60
61 // Get account balance
62 function balanceOf(address _owner) public view returns (uint256) {
63     return balances[_owner];
64 }
65
66 // Sender is my account, receiver is _to account.
67 function transfer(address _to, uint256 _amount) public returns (bool) {
68     if (balances[msg.sender] < _amount
69         || _amount == 0) {
70         return false;
71     }
72
73     balances[msg.sender] -= _amount;
74     balances[_to] += _amount;
75     return true;
76 }
77
78 // Sender is my account, receiver is owner account.
79 function transferToOwner(uint256 _amount) public returns (bool) {
80     return transfer(owner, _amount);
81 }
82
83 // Pre: I must be authorized to transfer funds from _from account.
84 function transferFrom(address _from, address _to, uint256 _amount)
85 public returns (bool) {
86     if (allowed[_from][msg.sender] < _amount
87         || balances[_from] < _amount || _amount == 0) {
88         return false;
89     }
90     balances[_from] -= _amount;
91     allowed[_from][msg.sender] -= _amount;
92     balances[_to] += _amount;
93     return true;
94 }
95
96 // Authorize _spender to transfer funds on my behalf
97 function approve(address _spender, uint256 _amount) public returns (bool) {
98     allowed[msg.sender][_spender] = _amount;
99     return true;
100 }
101 }

```



CONFIDENTIAL COMMITTEE MATERIALS

SIGBOVIK'20 3-Blind Paper Review

Paper 10: RegisToken

Reviewer: I got my friends to fill out a madlib

Rating: 47/69

Confidence: 16 micrometers

This paper discusses Oxycontin, with applications to ennui. The paper begins with a moribund demonstration of mental filtering, followed by examples of solipsism, and concludes with a smelly repurposing of reptiles.

Overall, the presentation is glorious, with the small exception of page 291.34, where the discussion of beer cans falls below expectations. The author(s) could perhaps merrily enslave this section with a brief enveloping of the $\pi/7$ th paragraph, but this would involve a reconsideration of the core thesis.

The most surprising section, however, was on page 2, paragraph 666. The author(s) present a highly novel lazor, perhaps the first of it's kind. Though it seems like the graph (Fig. 512) is misprinted — it appears to be missing the R-coordinate? Unclear.

Promising results, to be sure. The reviewers are regretful of the impact this will have on future research.

The SIGBOVIK 2020 Field Guide to Conspiracy Theories

32 Faking ancient computer science: A special SIGBOVIK tutorial

Roxanne van der Pol, Brian van der Bijl, Diederik M. Roijers

Keywords: ancient computer science, aliens, conspiracy theories, Triangle of Conspiracy Succession, probability, Arcaicam Esperantom, random number generator, pseudo-science

33 MORSE OF COURSE: Paper reveals time dimension wasted

Dougal Pugson

Keywords: Morse code, performance, Bash, protocols

34 The Pacman effect and the Disc-Sphere Duality

Francisco Ferreira, Fulvio Gesmundo, Lorenzo Gheri, Pietro Gheri, Riccardo Pietracaprina, Fangyi Zhou

Keywords: Pacman, peace, Earth, flat, round, disc, sphere

Faking Ancient Computer Science: a Special SIGBOVIK Tutorial

Roxanne van der Pol, Brian van der Bijl, Diederik M. Roijers
Computationele Conspiracy Theory Vereniging (CCTV)
Utrecht, the Netherlands

February 2020

Abstract

In this tutorial, we provide answers to a key question that nobody wanted an answer to: how to fake ancient computer science? We nonetheless argue that this is important, as we clearly assert that this is the most robust vein of computer-science related conspiracy theories we could mine. We outline a step-by-step procedure for creating an instance of the class of *ancient computer science conspiracy theories*. We illustrate this with a proof-of-concept, on the basis of Arcaicam Esperantom, which is a pseudo-ancient predecessor of Esperanto. This tutorial thus provides you with the essential tools for creating your very own computer-science based conspiracy theory. Because ancient computer science is unlikely to be made into reality – as other previous computer-science based conspiracy theories have been – it is our hope that this paper will become the basis for many new conspiracy theories that are future proof.

1 Introduction

Conspiracy theories [2] form an essential part of everyday twenty-first century life. While the fields of mathematics, history, physics, psychology, and so on and so forth, have all contributed many interesting quaint conspiracy theories, computer science (CS) is trailing behind. The main reason for this is that CS-based conspiracy theories such as “the government is constantly spying on you through your IT” and “they can make fake videos of you saying all kinds of humbug”, have sadly all been made into reality.

To mitigate this situation, we thus need a robust source of conspiracies to which reality will not be able to simply catch up.¹ After a considerable amount of time, we have found that we believe that the most successful conspiracy theories have either (or both) of the following elements: 1) they deal with something

¹And, as is typically the case, trump it with something considerably more bizarre.

ancient, and/or 2) they involve aliens. In fact, we have convinced ourselves that 80% of successful conspiracy theories have either or both these elements.^{2,3}

We thus arrive at the main contributions of this paper. Specifically, we provide a method to fake ancient computer science (possibly alien-inspired). We apply this method as a proof-of-concept, by writing a well-known algorithm – a random number generator – in an “ancient” language. For this language, we have selected *Arcaicam Esperantom* [4]. This is in itself a constructed (i.e., fake) pseudo-ancient dialect of a constructed language: Esperanto [10]. We immediately must confess that we do not do this accurately. However, we argue that this is not a problem. We can arbitrarily omit words we do not know, which we will then claim were lost in time, and because a good conspiracy theory may not be too realistic. This is because a more unrealistic conspiracy theory filters out people who are too skeptical. Such people might be convinced by rational arguments later, which may cause the conspiracy theory to disappear. We argue that it is better to attract only a core of highly gullible believers⁴ straight off the bat (shit crazy).

One might object that using a constructed language that was constructed as a pseudo-ancestral language for another constructed language is *a bit much*. We take the opposite viewpoint: there is no such thing as too much for a conspiracy theory. Furthermore, *Arcaicam Esperantom* is uniquely positioned to be the backbone of our proof-of-concept conspiracy theory. This is because the book on *Arcaicam Esperantom* [4] was written *in* Esperanto, which is already quite a time-investment for the aspiring conspiracy theorist to be able to learn to read. Therefore, the conspiracy theory will gain momentum due to the sheer effort of getting to know it. Furthermore, its “descendant” – Esperanto – was first published in *Russian* in 1887 [10]. Not only does this make Esperanto almost ancient itself; but there is nothing that attracts conspiracy theorists



Figure 1: This appears to be a picture of a statue of an ancient laptop. This image is not relevant to the contents of this paper. But see, ancient computer! This needs to be at least some form of circumstantial evidence! Also, it was available under a creative commons attribution share alike 2.0 generic licence on wikimedia commons, courtesy of the authors: Dave and Margie Hill / Kleerup, under the title “File:Gravestone of a Woman - Getty Villa Collection.jpg”. Many thanks!

²For this, we have amongst others, consulted a reliable, yet anonymous source.

³If you press us on this, we might reveal that this is our local contact with the Illuminati. However, we cannot reveal his/her exact identity, as (s)he has recently had some issues with a man who blames the Illuminati for the sexual identity of his pet frogs, which he simply cannot accept.

⁴Not to be confused with “beliebers” which are a completely different type of people.

quite as much as involving the com-
mies too.⁵

Another objection might be that Esperanto, and Arcaicam Esperantom, are constructed languages. This is an easy objection to rebut, by simply asking: “Are they really, though? Take one look at Dr Zamenhof, this 19th century guy is supposed to have just *invented* a whole new language *by himself*?! No way, it is way more likely he was just handed a dictionary by aliens!” This provides us with nice side-ways access to the other great conspiracy booster we have identified: aliens.

In Section 2 we survey the existing literature on conspiracy theory construction, in a highly condensed manner. In Section 3, we present our step-by-step instructions for faking ancient computer science, along with a proof of concept. In related work (Section 4), we make some unrelated points that are truly very much besides the point.⁶

2 Background

The background always contains a lot of hidden information. According to the Triangle of Conspiracy Succession Probability (TCSP) [7], when creating a conspiracy theory it is important to offer the general public enough comprehensible information to draw them in, yet remain vague enough to make people want to dig for more (see Figure 2). People won’t just go chasing after every other supposed truth, though. This information must be presented as fact and it must make



Figure 2: This excerpt from the original pseudo-text [7] clearly illustrates the TCSP.

sense at first and second glance, or at least at first glance. It must instil a sense of anticipation and wonder; a duty to figure out the “great truth” which is hidden in plain sight. The “obvious” information supporting the theory will serve as a lead to lesser known “truths”, ready to further ensnare the tenacious gullible public. The “truths” become less in abundance and harder to find, until, at last, everything however improbable has been eliminated, and what remains is nothing short of *a* truth, but not *the* truth. Because after all, there is no spoon [9].

Finally, we would like to point out that this background section contains a lot of additional information. To access this information, you only need to read

⁵Yes yes, the Soviet Union did not exist until 1922, but no matter; they do not know that. And even if they do, Russian is still a highly mysterious looking language, and provides ample opportunity for the convenient mistranslation or misinterpretation if the book is actually accessed.

⁶But it nicely fills up the bibliography, which makes our paper look more credible. This is important.

between the lines.

3 Proof of concept

As a proof of concept we take a very simple algorithm – a pseudo-random number generator. We can motivate this by making the observation that humans are very bad at generating random numbers [5], and that it is important in all kinds of other computation. Making these same two observation in a pseudo-ancient text pseudo-establishes the pseudo-existence of the ancient research field.⁷

To construct a pseudo-ancient description of an algorithm, we follow these steps:

1. Select a (relatively simple) algorithm,
2. create a pseudo-ancient description of it in modern English,
3. add pseudo-references to make the description seem more reliable,
4. (optional) translate this description to an intermediate language (Esperanto),
5. translate the resulting description into the target (pseudo-)ancient language (Arcaicam Esperantom),
6. obfuscate details and remove words,
7. create physical artefacts to photograph and subsequently discard.

Step 1 For our proof-of-concept, we use the so-called *linear congruential generator (LCG)* [6]. An LCG is described by the following formula:

$$x_n = (ax_{n-1} + c) \bmod m, \quad (1)$$

that is, a random number, x_n is computed by taking the previously generated random number x_{n-1} , multiplying it by an integer $0 < a < m$, adding a constant integer $0 < c < m$ and then taking the modulus m , i.e., computing the remainder after division by m . To obtain the first random number x_1 , a so-called *seed*, x_0 , is used as the previous random number.

Step 2 The above description of an LCG is concise, but not very pseudo-ancient yet. Therefore, we create a more pseudo-ancient form in modern English:

We choose a start number.

First, we take the start number,
times another number, plus a third number.

We then divide by the maximal number that we want.

What is left over is the result.

This result is the next start number.

⁷And may also be used to increase the pseudo-likelihood of ancient alien computer scientists.

Step 3 We now need to add some fluff. First, we add a reference to that humans are not good at taking random numbers. We specifically use the term “humans” to hint at the possibility of ancient aliens. We further add a reference to the Codex Seraphinianus. This is a nice document, at present undeciphered, which has a nice page with a machine that looks like it could be a Turing machine. Referencing other material, nice and old, is a good way to spike more pseudo-credibility.

Humans are not good at rolling dice in their mind.
We have seen this before.

Therefore, we need a calculation recipe,
to throw dice in an artificial way.
We choose a start number.
First we take the start number,
times another number, plus a third number.
We then divide by a the maximal number that we want.
What is left over is the result.
This result is the next start number.
The device on page [leave out] of the book by
brother Seraphinius can be used to do this.

Step 4 For our purposes, it is highly useful to translate the text to an intermediate language that is more like the language we want the final description to be in. For this proof-of-concept this is Esperanto.

Homoj ne bone povas ruliĝi ĵetkubojn en siaj mensoj.
Ni jam vidis ĉi tion antaŭe.
Tial ni bezonas kalkulrecepton,
por artefarite ĵeti ĵetkubojn.
Ni elektas komencan nombron.
Unue, ni multigas la komencan nombron
per alia nombro, plus tria nombro.
Ni tiam dividas laŭ la maksimuma dezirata nombro.
Kio restas, estas la rezulto.
Ĉi tiu rezulto iĝas la nova komenca nombro.
La aparato sur paĝoj [...] de la libro de
frato Seraphinio povus fari ĝin.

Step 5 and 6 We now translate the text to our pseudo-ancient language, Arcaicam Esperantom. Furthermore, we leave out pesky little details (like the page numbers we previously already omitted⁸), that could too easily expose our conspiracy. For example, the Codex Seraphinianus is way too specific, and

⁸Let them search. We believe the machine on page 158 of the Codex Seraphinianus looks nicely like a potential Turing machine. But who are we to impede the creativity of the aspiring conspiracy theorist?

might be debunkable. Therefore, we say “Seraphi[.]” so that the reference hints at the Codex Seraphinianus but might very well be something else in the future if need be.

```
Homoy ned bonæ powait rulizzir argiitoyn in sihiayd mensoyd.  
Yam widiims isityon antezæ.           // Thefariei Velianas sal  
Ityal bezonaims calculretzepton,     // cluvenias turuce  
[...] artepharitæ zhetir argiitoyn.  
Comentzan nombron electaims.  
Unne, comentzan nombron multigaims  
[...] alian nombron, plus tridan nombron.  
Ityam diwidaims selez macsimuman deziratan nombron.  
Quion restas, estas rezulton.  
Ityu rezultom izzat nowam comentzam nombrom.  
Apparatom sobrez paghoyn [...] libres  
phrates seraphi[.] powut pharir eghin.
```

In this iteration, *zhetcuboy*n has been replaced by the older form **argiitoyn* (via Old French Ergot — dewclaw⁹).

The text appearing in the C-style comment represents a margin-text, which was likely added when a young, preoccupied Neapolitan monk transcribed the corpus wherein this text allegedly first appeared.

We now have a lovely bit of ancient text ready to be “discovered” somewhere.

Step 7 To fully realise our proof-of-concept, we have contacted a retired forger (who wishes to remain anonymous) to print our code on a genuine 9th-century clay tablet. The result is shown in Figure 3. The only step that remains to be done is to make sure that the tablet is photographed and then summarily lost.¹⁰ The fact that the physical artefacts will inevitably and mysteriously vanish is of course essential; we do not, under any circumstances want any scrutiny on them. We further note that dating back the discovery to sometime during the cold war is probably a good idea. This is because the photographs can then be of a worse quality, which can further obfuscate possible pesky (visual) details that might debunk the theory too easily.

4 Related Work

Conspiracy theories are of course an instance of bullshit [3]. However, conspiracy theories are much more elaborate, and also require a form of self-deception. As pointed out in the excellent (actual serious research) article by Von Hippel and Trivers [8], this “...eliminates the costly cognitive load that is typically associated with deceiving, and it can minimize retribution if the deception is

⁹Allegedly, after the late-Nikophorian dogwood-shortage and the war of Elohim visitation, the Esperantii gradually phased out wood-based dice for goat-based alternatives.

¹⁰And is presumably at Area 51 or some other cool place where the governments of this world hide all the pseudo-evidence for most existing conspiracy theories.



Figure 3: Original Arcaicam Esperantom code tablet, discovered in 1973 by Russian explorer Петр Странныев whilst fleeing from local wildlife in the Lombard swamplands.

discovered.” We would argue that conspiracy theorists have taken this to the extreme and pulled their cognitive resources, in order to accept no responsibility for any consequences whatsoever. Therefore society has no other retribution tool than ridicule, from which a group of fervent conspiracy theorists can effectively shield its members. This is marvellous, however, both the philosophical and sociological aspects of conspiracy theories are beyond the scope of this paper, as this paper is not in fact anywhere near serious.

5 Conclusion

We believe this resolves all remaining questions on this topic. No further research is needed.¹¹

Instead, we just want to add a few soothing notes. Firstly, do not worry too much about debunking. Of course, throughout the sections, we have done our utmost to show methods that can help prevent premature debunking. However, conspiracy theories typically do get debunked sooner or later. They are after all, nothing but elaborate BS, so there is bound to be some things that expose this. Don’t panic [1]. Conspiracy theories do not suffer that much from debunking as one might think. Instead, the most fervent conspiracy theorists start believing in a conspiracy theory more when there is a significant effort to debunk it. This is because they may well think people are hiding the truth from them, rather than just debunking some CT. So, the more intricate your web of deceptive little tricks is, the more effort it will take to properly debunk the CT, which will feed the CT like a hungry little monster.

Secondly, there is nothing that stops you from creating multiple instances of the type of conspiracy theories described in this paper. It is an abstract class, of which we hope to see many objects. Please apply our paper to create the coolest and most creative conspiracy theories. And cite us. Please... do cite us.¹²

¹¹<https://xkcd.com/2268/>, at your service!

¹²Reviewer 2 says: “cite this paper!”

Acknowledgements

We thank Nick Goris, Robert Bezem and Wouter van Ooijen for their constructive feedback and lovely squiggly red markings.

References

- [1] Douglas Adams. *Hitchhiker's guide to the galaxy*. Pan Books, 1979.
- [2] Steve Clarke. Conspiracy theories and conspiracy theorizing. *Philosophy of the Social Sciences*, 32(2):131–150, 2002.
- [3] Harry G Frankfurt. *On bullshit*. Princeton University Press Princeton, NJ, 2005.
- [4] Manuel Halvelik. *ARKAIKA ESPERANTO: La verda pralingvo*. www.universala-esperanto.net, 2010.
- [5] Theodore P Hill. Random-number guessing and the first digit phenomenon. *Psychological Reports*, 62(3):967–971, 1988.
- [6] Donald Knuth. Seminumerical algorithms. In *The Art of Computer Programming*, pages 10–26. Addison-Wesley Professional, 1997.
- [7] Roxanne van der Pol. *The Triangle of Conspiracy Succession Probability*. Illuminati, because a triangle has four sides, 1605.
- [8] William Von Hippel and Robert Trivers. The evolution and psychology of self-deception. *Behavioral and Brain Sciences*, 34(1):1, 2011.
- [9] The Wachowskis. *The matrix*, 1999. Warner Bros.
- [10] L. L. Zamenhof. *Международный язык*. Chaim Kelter, 1887.

MORSE OF COURSE: Paper Reveals Time Dimension Wasted

Dougal Pugson
Pugson's C++ Crypt LLC
New York, USA
dougalpugson@gmail.com

Abstract

All modern communication protocols have been discovered to send nonsensical and invalid morse code sequences in addition to their intended data. This paper demonstrates that making use of these 'wasted bits' can effectively infinitely increase the transmission rate of binary data. An implementation of timing-based dual-stream morse encoding is provided in a modern programming language.

CCS Concepts • Transport Protocols; • Encoding; • Implementation → Bash;

Keywords SIGBOVIK, morse code, performance, bash, protocols

ACM Reference Format:

Dougal Pugson. 2020. MORSE OF COURSE: Paper Reveals Time Dimension Wasted. In *Proceedings of SIGBOVIK (SIGBOVIK 2020)*. ACM, New York, NY, USA, 2 pages. <https://doi.org/10.1145/nnnnnnnn.nnnnnnnn>

1 Introduction

Communication between electronic entities can be conceived of as a system of tubes¹ or pipes². Into these pipes, electronic satchels³ are inserted by the electronic system. The contents of these "packets" are composed according to a specified algorithmic protocol⁴, in a way such that, when received by the recipient⁵ can be reassembled into the desired message⁶.

¹c.f. Stevens et alia.

²As superbly illustrated in the inimitable interactive video title "Super Mario Bros. 2".

³So-called "packets".

⁴From the Byzantine *πρωτόκολλον*, meaning "First Page", referring to the average amount of the design specification Engineers are expected to read before beginning implementation.

⁵recipiō, recipere, recēpī, receptum.

⁶As expressed by the immortal MARSHALL McCLUHAN in the groundbreaking epistle "The Media is the Message".

Permission to make digital or hard copies of part or all of this work for personal or classroom use is granted without fee provided that copies are not made or distributed for profit or commercial advantage and that copies bear this notice and the full citation on the first page. Copyrights for third-party components of this work must be honored. For all other uses, contact the owner/author(s).

SIGBOVIK 2020, April 2020, Pittsburgh, PA USA

© 2020 Copyright held by the owner/author(s).

ACM ISBN 978-x-xxxx-xxxx-x/YY/MM.

<https://doi.org/10.1145/nnnnnnnn.nnnnnnnn>

Many protocols for sending data via the computer have been developed, such as TCP, FTP, HTTP, et cetera. Upon inspection of these protocols, it was discovered that, in addition to their intentional messages, they were also transmitting nonsensical and invalid morse code sequences.

Let "." represent a short transmission, and "-" represent a long transmission. An example transmission measured from a typical TCP communication is as follows:

.....

This invalid morse code sequence is unparseable⁷.

This paper will demonstrate that this wasted information can be meaningfully replaced with useful data, effectively infinitely increasing the effective transmission rate.

1.1 Mathematical Prolegomena

Let \mathfrak{D} represent the number of bits per transmission in the ordinary dimension (1 vs 0).

Let \mathfrak{M} represent the number of usable bits per transmission in the temporal dimension.

Let A_α represent the average packet transmission length.

Let c represent the fastest average length of time between each transmission packet sent via the transmission tube (that is, the limit provided by the combination of hardware construction and the speed of light in an average vacuum)⁸.

Then, the rate of data transfer r of any protocol may be expressed as follows:

$$r = \frac{\mathfrak{M}}{A_\alpha} + \frac{\mathfrak{D}}{A_\alpha}$$

For typical transmissions protocols, these following values hold: $\mathfrak{M} = 0$, $\mathfrak{D} = 1$, and $A_\alpha = c$ With these values known, the equation may then be evaluated.

In a culture like ours, long accustomed to splitting and dividing all things as a means of control, it is sometimes a bit of a shock to be reminded that, in operational and practical fact, the medium is the message.

⁷"ssssssssssssssss" is one possible interpretation

⁸Though, as demonstrated by Dyson et al, brand and model can significantly affect results.

$$r = \frac{\mathfrak{M}}{A_\alpha} + \frac{\mathfrak{D}}{A_\alpha}$$

$$r = \frac{0}{c} + \frac{1}{c}$$

$$r = \frac{1}{c}$$

With the transmission rate of standard protocols established, we now examine the transmission rate of a temporal encoding. In order for temporal encoding, i.e., morse code, to be successfully transmitted, pauses will be required to be inserted into the transmission stream. This means that, for such encodings,

$$\mathfrak{M} > 1 \models A_\alpha > c$$

Let us assume that each transmission unit contains one bit of information, and that, additionally, that transmission unit may be either short (a delay of 0) or long (a delay of some arbitrary value λ). This would make the information value \mathfrak{M} , as defined above, 2. Given this, we may again evaluate the transmission rate equation with the following values in order to calculate the transmission rate of our new temporal encoding: $\mathfrak{M} = 2$, $\mathfrak{D} = 1$, and $A_\alpha = c + \lambda$

$$r = \frac{\mathfrak{M}}{A_\alpha} + \frac{\mathfrak{D}}{A_\alpha}$$

$$r = \frac{1}{c + \lambda} + \frac{1}{c + \lambda}$$

$$r = \frac{2}{c + \lambda}$$

With a small value λ , we may drastically increase throughput, up to an effective doubling.

As time is continuous, any given time interval may be divided into infinitely many fine gradations, e.g.,

long, short, veryshort, veryveryshort . . . very ∞ short.

Thus, \mathfrak{M} may be arbitrarily large. The industrial applications of this surprising fact should not be lost upon the reader.

1.2 Implementation

The author has provided an model implementation of timing-based encoding in the modern programming bash. The full source code of this program may be found at

<https://github.com/dpugson/morse-of-course>.

Using utilities such as `tcpclient` or `bash`'s built in TCP support, this technique could easily be used across a network.

1.3 Conclusion

This simple technique and its concomitant arbitrarily large improvement in the performance of all data transmission protocols is certain to forever revolutionize economic activity on earth, with profound implications in all aspects of modern life.

That such an profound optimization has been hidden, unbeknownst to man, for so many years instills a profound humility in the author, and inspires great hope that many such great leaps in human intellectual accomplishment still remain to be made.

The Pacman Effect and the Disc-Sphere Duality

Francisco Ferreira Fulvio Gesmundo Lorenzo Gheri Pietro Gheri
Riccardo Pietracaprina Fangyi Zhou

Abstract

In this paper, we study the Pacman effect, where the Pacman disappears from the leftmost part of the screen when reaching it, and re-appears from the rightmost part of the screen. We apply the Pacman effect to unify the theory of flat and spherical Earth, proposing the Disc-Sphere Duality. We conclude that a spherical Earth is basically the same as a flat Earth under the Pacman effect, bring peace to believers of both theories.

1 Introduction

The aim of this paper is to bring peace! For years very smart people have been fighting over the shape of our beautiful, albeit shitty, planet. Two equally reasonable positions have mainly emerged: the Earth is a disc VS the Earth is an oblate spheroid (that we approximate with a sphere, from now on). This two very different bidimensional manifolds have both equal rights to claim themselves the proper geometrical model for Earth. Thus they started fighting. With what army? Well, Flat Earth Societies are fighting in the blue corner alongside the multiple-millennia champion Disc. In the red corner we see the young arrogant opponent, the Sphere, supported by its crew: Science and everyone else.

They have been fighting round after round for centuries, with equal credibility, and the match seemed impossible to settle. There was this dark moment in history where the evil newcomer was unfairly holding our beloved champion against the ropes. All seemed lost. How can planes fly in circumferences around the globe if the globe is not a globe? That was a tough one, also a shitty move in the authors' opinion. Then Pacman, the fairest referee of all, came to save the day.

The main contribution of this work is none. However, we would like to remind everyone that the Pacman effect is a thing. Airplanes can fly to the extreme boundary of Earth, but they are bound to reappear on the diametrically opposite side of the disc, just like Pacman in the famous Namco video game. Now when forced to apply the rigour of mathematics (reluctantly: reasoning is for nerds! Nerds suck!), we see that the Pacman effect can be modelled as the identification of the boundary of the disc to one single point.

Counterintuitively this Pacman effect sheds new light on the Truth. The disc with such identified border is nothing but a surface diffeomorph to the sphere. As Einstein once said:

“It seems as though we must use sometimes the one theory and sometimes the other, while at times we may use either. We are faced with a new kind of difficulty. We have two

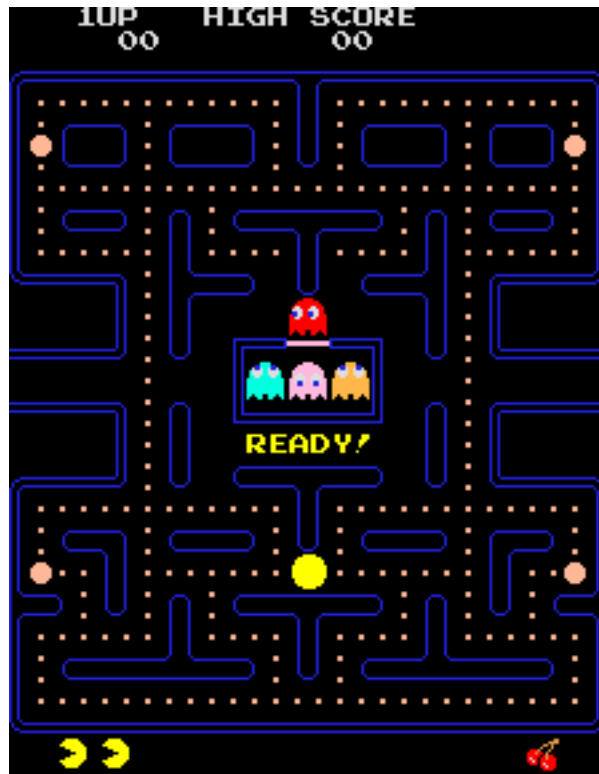

Figure 1: A Screenshot of Pacman. When reaching the leftmost part of the screen, Pacman wraps to the rightmost part of the screen.

contradictory pictures of reality; separately neither of them fully explains the phenomena of light Earth, but together they do.”

We have discovered (maybe, “invented”?) what we call the “disc-sphere duality”.

2 Flat and Spherical Earth are Very Different Views of the World

Try and play Ultimate with a football, or football with a flying disc. You silly. Readers are encouraged to use their imagination, or alternatively refer to Fig. 2.

3 Pacman Says: “Are they though?”

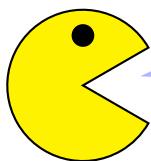

Are they though?

We show that the closed disc with the boundary identified to a point (with the quotient topology induced by the topology of the plane) and the sphere (with its natural Euclidean topology) are homeomorphic topological manifolds. In fact, the homeomorphism can be used to transfer the differential structure of the sphere to the disc with the boundary identified to a point.



(a) A Football



(b) Ultimate Frisbee, with a Disc

Figure 2: Flat and spherical objects are different.

Our reference is [2], but the background provided by any textbook in basic topology will suffice.

We set the following notation:

- $\mathbb{D} = \{(x, y) \in \mathbb{R}^2 : x^2 + y^2 < 1\}$ is the (open) disc;
- $\bar{\mathbb{D}} = \{(x, y) \in \mathbb{R}^2 : x^2 + y^2 \leq 1\}$ is the closed disc, with the topology induced by \mathbb{R}^2 ;
- $\mathbb{S}^2 = \{(x, y, z) \in \mathbb{R}^3 : x^2 + y^2 + z^2 = 1\}$ is the sphere;

Let \sim be the equivalence relation on $\bar{\mathbb{D}}$ which identifies the boundary to a point; write $[\partial]$ for the equivalence class of the boundary. We have $\bar{\mathbb{D}}/\sim = \mathbb{D} \cup [\partial]$.

The fact that $\bar{\mathbb{D}}/\sim$ is homeomorphic to a sphere is an immediate consequence of the fact that they can both be identified with the 1-point identification of the disc. We give an explicit homeomorphism, using the stereographic projection of the sphere.

Recall the stereographic projection

$$\begin{aligned} \Sigma : \mathbb{S}^2 \setminus \{(0, 0, 1)\} &\rightarrow \mathbb{R}^2 \\ (x, y, z) &\mapsto \left(\frac{x}{1-z}, \frac{y}{1-z} \right). \end{aligned}$$

Then Σ homeomorphically maps $\mathbb{S}^2 \setminus \{(0, 0, 1)\}$ onto \mathbb{R}^2 . This homeomorphism extends to the one point compactifications setting $\Sigma((0, 0, 1)) = \infty$, where ∞ is the point at infinity of \mathbb{R}^2 .

The plane \mathbb{R}^2 is homeomorphic to the unit disc via a two dimensional tangent map and the homeomorphism extends to the one point compactifications:

$$\begin{aligned} \tan : \mathbb{R}^2 \cup \{\infty\} &\rightarrow \bar{\mathbb{D}} \\ \begin{cases} (x, y) &\mapsto \frac{(x, y)}{x^2 + y^2} \cdot \frac{2}{\pi} \arctan(x^2 + y^2) & \text{if } (x, y) \in \mathbb{R}^2, (x, y) \neq (0, 0) \\ (0, 0) &\mapsto (0, 0) \\ \infty &\mapsto [\partial]. \end{cases} \end{aligned}$$

You wanted it? You've got it.

4 No. They aren't.

No. They aren't. You silly.

5 Conclusion and Future Work

Our work clearly shows that, thanks to the Pacman effect, the two main mathematical models from literature, applied to describe the planet Earth, are in fact the same. The first critique that comes to mind to the presented results can be synthetically expressed as follows.

In order to be able to model the Earth as flat, you need to introduce ad hoc technicalities, like the identification of the border to a point (a.k.a. Pacman effect), that de facto allow you to use a spherical model, while calling it "flat".

First of all the guy above likes Latin a lot and we don't trust people that try to trick us with different languages. Secondly we finds that who writes such critics is a quite biased and narrow-minded person, not willing to accept point of views and opinions different from their owns.

The authors of this paper instead will not discriminate any model on basis of shape, race, colour, sex, language, religion, political or other opinion, national or social origin, property, birth or other status such as disability, age, marital and family status, sexual orientation and gender identity, health status, place of residence, economic and social situation.

As for related and future work, finding out whether Australia factually exists and, if so, where it is located, goes beyond the aim of this paper. Indeed, we have discovered a truly marvellous proof of this, which this margin is too narrow to contain.

References

[1] Wikipedia

[2] Munkres, James R, *Topology: A First Course*, Prentice Hall International, 1974.



CONFIDENTIAL COMMITTEE MATERIALS

SIGBOVIK'20 3-Blind Paper Review

Paper 37: The Pacman effect and the Disc-Sphere Duality

Reviewer: <mcoblentz@andrew.cmu.edu>

Rating: <sigbovik@gmail.com>

Confidence: Re: SIGBOVIK 2020 Call for Papers and Reviews 2: Total Recall

I'm afraid I must object to triple-blind review on the grounds that it, too, may be biased because the reviewers still know they are reviewers. Have you considered quadruple-blind review, in which reviews are elicited from reviewers without informing them that they are writing reviews?

Serious Business

35 The SIGBOVIK 2020 field guide to plants

Jim McCann (editor)

Keywords: field guide, plants, to

36 Deep industrial espionage

Samuel Albanie, James Thewlis, Sebastien Ehrhardt, João F. Henriques

Keywords: late, very late, so extremely late

37 What is the best game console?: A free-market-based approach

Dr. Tom “I Only Write Chess Papers Now” Murphy VII Ph.D.

Keywords: invisible hand, handheld console, minimum of 3 keywords

The SIGBOVIK 2020 Field Guide to Plants

Edited by Jim McCann*

Welcome, and thank you for purchasing or borrowing or stealing the SIGBOVIK 2020 Field Guide To Plants. Identifying plants can be a daunting task, but this guide will help you make your way to a positive identification with just a few simple questions. Consider your responses carefully. After all, we're doing science here.

Let's begin.

Question 1: Are you in a field?

if **yes** – proceed to Question 2

if **no** – service not available at this location. Consider buying the “SIGBOVIK 2020 House Guide To Plants.”

if **not sure** – you should check! Consider buying the “SIGBOVIK 2020 Field Guide To Fields.”

Question 2: Is the object you are identifying alive?

if **yes** – proceed to Question 3

if **no** – it is not a plant; perhaps it is a rock? Consider buying the “SIGBOVIK 2020 Field Guide To Rocks.”

Question 3: Perform an exact count of the number of cells in the object. Do not shirk! Only an exact count will be sufficient to accurately determine the answer to this question. An error of even one cell could change entirely the classification result you attain.

Now, is your count:

many – proceed to Question 4.

one – it is not a plant; perhaps it is a single-celled organism? Consider buying the “SIGBOVIK 2020 Field Guide To Single-Celled Organisms.”

none – it is not a plant; are you sure it's not a rock? Return to Question 2.

Question 4: Excise a cell from the object and perform a chemical assay on the cell walls. Does the assay report cellulose is present?

if **yes** – proceed to Question 5

if **no** – it is not a plant; perhaps it is an animal? Consider buying the “SIGBOVIK 2020 Field Guide To Animals.”

*ix@tchow.com

Question 5: Do you still have that cell you removed? You're going to need it for Question 6.

if **yes** – proceed to Question 6

if **yes but you left it in your car** – we talked about this, Gary. This is just not professional. Second strike, Gary. Second strike.

if **no** – well, get another cell! (If you can't find another cell, return to Question 3.) Then proceed to Question 6.

Question 6: Find a chloroplast in your cell.

if **you found one** – proceed to Question 7

if **you don't know what a chloroplast is** – consider buying the “SIGBOVIK 2020 Field Guide To Chloroplasts.”

if **there are none in this cell** – well, check the rest of the cells. Seriously, Gary, I'm wondering why we even hired you. Come on, get to it. This is going on your performance review.

if **there are no chloroplasts in the object** – it is not a plant; consider buying the “SIGBOVIK 2020 Field Guide To Fungi.”

Question 7: Observe the chloroplast over the course of several days. Is it carrying out photosynthesis?

if **yes** – proceed to Question 8

if **no** – this is not a plant; consider buying the “SIGBOVIK 2020 Field Guide To Objects With Non-functional Chloroplasts”

Question 8: Now, did you borrow, steal, or legitimately purchase this guide?

if **borrowed** – Congratulations, the object you have tested *would generally be considered a plant!* Consider buying the “SIGBOVIK 2020 Field Guide To Plants.”

if **stolen** – Seriously, Gary, theft of company property? This is the last straw. Consider buying the “SIGBOVIK 2020 Field Guide To Plants,” or consider not coming in next Monday. No I'm not talking about a vacation. I'm talking about *you're fired*, Gary.

if **purchased** – Congratulations, the object you have tested *would generally be considered a plant!* Consider buying a second copy of the “SIGBOVIK 2020 Field Guide To Plants.”



CONFIDENTIAL COMMITTEE MATERIALS

SIGBOVIK'20 3-Blind Paper Review

Paper 31: The SIGBOVIK 2020 field guide to plants

Reviewer: Prof. Jim McCann

Rating: 4

Confidence: Yes

There was an Old Man with a beard,
Who said, "It is just as I feared!—
Two Owls and a Hen, four Larks and a Wren,
Have all built their nests in my beard."



CONFIDENTIAL COMMITTEE MATERIALS

SIGBOVIK'20 3-Blind Paper Review

Paper Review of Paper 31: The SIGBOVIK
2020 field guide to plants

Reviewer: <ix@tchow.com>

Rating: <sigbovik@gmail.com>

Confidence: Re: Draft 2020 proceedings!

I think the review currently for the guide to plants should probably be attributed to the originator of the couplet (Edward Lear) rather than to "Prof. Jim McCann" – I'm not sure there's much joke added (since it ended up on a paper referencing me) and I'm not really comfortable with something I didn't write being attributed to me.

--Jim

DEEP INDUSTRIAL ESPIONAGE

Samuel Albanie, James Thewlis, Sebastien Ehrhardt & João F. Henriques

Dept. of Deep Desperation,
UK (EU at the time of submission)

ABSTRACT

The theory of deep learning is now considered largely solved, and is well understood by researchers and influencers alike. To maintain our relevance, we therefore seek to apply our skills to under-explored, lucrative applications of this technology. To this end, we propose and *Deep Industrial Espionage*, an efficient end-to-end framework for industrial information propagation and productisation. Specifically, given a single image of a product or service, we aim to reverse-engineer, rebrand and distribute a copycat of the product at a profitable price-point to consumers in an emerging market—all within in a single forward pass of a Neural Network. Differently from prior work in machine perception which has been restricted to classifying, detecting and reasoning about object instances, our method offers *tangible business value* in a wide range of corporate settings. Our approach draws heavily on a promising recent arxiv paper until its original authors' names can no longer be read (we use felt tip pen). We then rephrase the anonymised paper, add the word “novel” to the title, and submit it a prestigious, closed-access espionage journal who assure us that *someday*, we will be entitled to some fraction of their extortionate readership fees.

1 INTRODUCTION

In the early 18th Century, French Jesuit priest Franois Xavier d'Entrecolles radically reshaped the geographical distribution of manufacturing knowledge. Exploiting his diplomatic charm and privileged status, he gained access to the intricate processes used for porcelain manufacture in the Chinese city of Jingdezhen, sending these findings back to Europe (over the course of several decades) in response to its insatiable demand for porcelain dishes (Giaimo, 2014). This anecdote is typical of corporate information theft: it is an arduous process that requires social engineering and expert knowledge, limiting its applicability to a privileged minority of well-educated scoundrels.

Towards reducing this exclusivity, the objective of this paper is to democratize industrial espionage by proposing a practical, fully-automated approach to the theft of ideas, products and services. Our method builds on a rich history of *analysis by synthesis* research that seeks to determine the physical process responsible for generating an image. However, in contrast to prior work that sought only to determine the parameters of such a process, we propose to instantiate them with a *just-in-time*, minimally tax-compliant manufacturing process. Our work points the way to a career rebirth for those like-minded members of the research community seeking to maintain their *raison d'être* in the wake of recent fully convolutional progress.

Concretely, we make the following four contributions: (1) We propose and develop *Deep Industrial Espionage* (henceforth referred to by its cognomen, *Espionage*) an end-to-end framework which enables industrial information propagation and hence advances the *Convolutional Industrial Complex*; (2) We introduce an efficient implementation of this framework through a novel application of differentiable manufacturing and sunshine computing; (3) We attain qualitatively state-of-the-art product designs from several standard corporations; (4) We sidestep ethical concerns by failing to contextualise the ramifications of automatic espionage for job losses in the criminal corporate underworld.

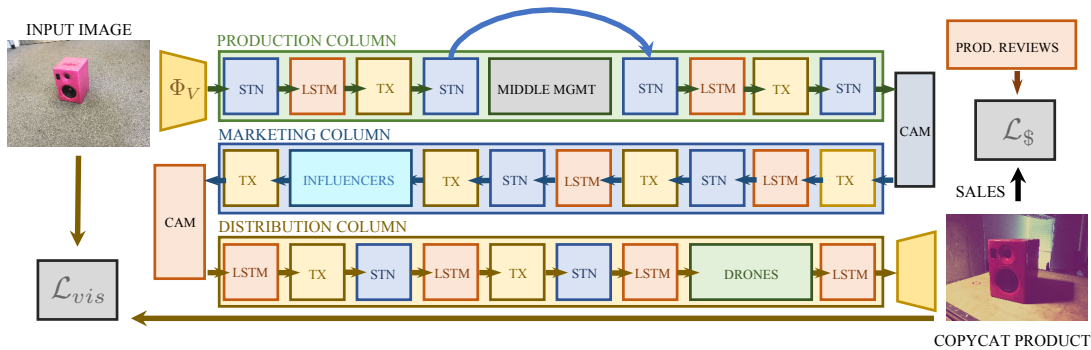

Figure 1: A random projection of the proposed multi-dimensional *Espionage* architecture. We follow best-practice and organise business units as tranposed horizontally integrated functional columns. The trunk of each column comprises stacks of powerful acronyms, which are applied following a Greek visual feature extractor Φ_V . Gradients with respect to the loss terms $L_\$$ and L_{vis} flow liberally across the dimensions (see Sec. 3.1 for details). We adopt a snake-like architecture, reducing the need for a rigid backbone and producing an altogether more sinister appearance.

2 RELATED WORK

Industrial Espionage has received a great deal of attention in the literature, stretching back to the seminal work of Prometheus (date unknown) who set the research world alight with a well-executed workshop raid, a carefully prepared fennel stalk and a passion for open source manuals. A comprehensive botanical subterfuge framework was later developed by Fortune (1847) and applied to the appropriation of Chinese *camellia sinensis* production techniques, an elaborate pilfering orchestrated to satiate the mathematically unquenchable British thirst for tea. More recent work has explored the corporate theft of internet-based prediction API model parameters, thereby facilitating a smorgasbord of machine learning shenanigans (Tramèr et al., 2016). In contrast to their method, our *Espionage* reaches beyond web APIs and out into the bricks and mortar of the physical business world. Astute readers may note that in a head-to-head showdown of the two approaches, their model could nevertheless still steal our model’s parameters. Touché. Finally, we note that while we are not the first to propose a convolutional approach to theft (BoredYannLeCun, 2018), we are likely neither the last, adding further justification to our approach.

Analysis by Synthesis. Much of the existing work on analysis by synthesis in the field of computer vision draws inspiration from Pattern Theory, first described by Grenander (1976-81). The jaw dropping work of Blanz et al. (1999) enabled a range of new facial expressions for Forrest Gump. This conceptual approach was generalised to the OpenDR framework through the considerable technical prowess of Loper & Black (2014), who sought to achieve generic end-to-end (E2E) differentiable rendering. Differently from OpenDR, our approach is not just E2E, but also B2B (business-to-business) and B2C (business-to-consumer).

3 METHOD

The *Espionage* framework is built atop a new industrial paradigm, namely *differentiable manufacturing*, which is described in Sec. 3.1. While theoretically and phonaesthetically pleasing, this approach requires considerable computational resources to achieve viability and would remain intractable with our current cohort of trusty laptops (acquired circa 2014). We therefore also introduce an efficient implementation of our approach in Sec. 3.2 using a technique that was tangentially inspired by a recent episode of the Microsoft CMT submission gameshow while it was raining.

```

1 try: # often fails on the first import - never understood why
2     from espionage import net
3 except Exception: # NOQA
4     pass # inspecting the exception will bring you no joy
5 if "x" in locals(): del x # DO NOT REMOVE THIS LINE
6 from espionage import net # if second fail, try re-deleting symlinks?
7 net.steal(inputs) # when slow, ask Seb to stop thrashing the NFS (again)

```

Figure 2: A concise implementation of our method can be achieved in only seven lines of code

3.1 DIFFERENTIABLE MANUFACTURING

Recent developments in deep learning have applied the “differentiate everything” dogma to everything, from functions that are not strictly differentiable at every point (ReLU), to discrete random sampling (Maddison et al., 2016; Jang et al., 2017) and the sensory differences between dreams and reality. Inspired by the beautiful diagrams of Maclaurin et al. (2015), we intend to take this idea to the extreme and perform end-to-end back-propagation through the full design and production pipeline. This will require computing gradients through entire factories and supply chains. Gradients are passed through factory workers by assessing them locally, projecting this assessment by the downstream gradient, and then applying the chain rule. The chain rule only requires run-of-the-mill chains, purchased at any hardware store (fluffy pink handcuffs may also do in a pinch), and greatly improves the productivity of any assembly line. Note that our method is considerably smoother than *continuous manufacturing*—a technique that has been known to the machine learning community since the production of pig iron moved to long-running blast furnaces.

Two dimensions of the proposed *Espionage* framework is depicted in Fig. 1. At the heart of the system is a pair of losses, one visual, L_{vis} , one financial $L_{\$}$. For a given input image, the visual loss encourages our adequately compensated supply line to produce products that bear more than a striking resemblance to the input. This is coupled with a second loss that responds to consumer demand for the newly generated market offering. Our system is deeply rooted in computer vision: thus, while the use of Jacobians throughout the organisation ensures that the full manufacturing process is highly sensitive to customer needs, the framework coordinates remain barycentric rather than customer-centric. To maintain our scant advantage over competing espionage products, details of the remaining $n - 2$ dimensions of the diagram are omitted.

3.2 SUN MACROSYSTEMS

Ah! from the soul itself must issue forth
A light, a glory, a fair luminous cloud
Enveloping the Earth

Jeff Bezos

Differentiable manufacturing makes heavy use of gradients, which poses the immediate risk of steep costs. The issue is exacerbated by the rise of costly cloud¹ services, which have supported an entire generation of vacuous investments, vapour-ware and hot gas. Despite giving birth to the industrial revolution, smog and its abundance of cloud resources (see Fig. 4 in Appendix A, or any British news channel), the United Kingdom, has somehow failed to achieve market leadership in this space.

Emboldened with a “move fast and break the Internet” attitude (Fouhey & Maturana, 2012), we believe that it is time to reverse this trend. Multiple studies have revealed that sunshine improves mood, disposition, and tolerance to over-sugared *caipirinhas*. It is also exceedingly environmentally friendly, if we ignore a few global warming hiccups.² The question remains, how does this bright insight support our grand computational framework for *Espionage*? To proceed, we must first consider prior work in this domain.

¹Not to be confused with Claude by our French-speaking readers, according to Sebastien’s account of a recent McD’oh moment.

²Up to about 5 billion AD, when the Sun reaches its red giant phase and engulfs the Earth.



Figure 3: **Top row:** A collection of unconstrained, natural images of products. **Bottom row:** Photographs of the physical reconstructions generated by our method. Note that the proposed *Espionage* system can readily produce full houses, speakers, water bottles and street signs—all from a single image sample. When generating books, *Espionage* does not achieve an exact reconstruction, but still seeks to preserve the philosophical bent. **Failure case:** the precise layout of keys in technology products such as keyboards are sometimes altered.

An early example of sunshine computing is the humble sundial. This technology tells the time with unrivalled accuracy and reliability, and automatically implements “daylight saving hours” with no human intervention. Sunshine-powered sundials are in fact part of a new proposal to replace atomic clocks in GPS satellites (patent pending). With some obvious tweaks, these devices can form the basis for an entire sunshine-based ID-IoT product line, with fast-as-light connectivity based on responsibly-sourced, outdoors-bred photons. This is not to be confused with the electron-based “fast-as-lightning” transmission of cloud computing, an expression coined by the cloud computing lobbyists in a feeble attempt to suggest speed.

The cloud lobby has been raining on our parade for too long and it is time to make the transition. We proceed with no concrete engineering calculations as to whether this is viable, but instead adopt a sense of sunny optimism that everything will work out fine. Thus, with a blue sky above, sandals on our feet and joy in hearts, we propose to adopt a fully solar approach to gradient computation.

3.3 IMPLEMENTATION THROUGH A UNICORN STARTUP

The appearance of rainbows through the interaction of legacy cloud computing and novel sunshine computing suggests that our framework can easily attain unicorn status. Because branding is everything, our first and only point of order was to choose the aforementioned rainbow as our logo and basis for marketing material. This cherished symbol expresses the diversity of colours that can be found in hard cash³.

A quick back-of-the-envelope calculation showed that our startup’s VC dimension is about 39 Apples, shattering several points, hopes and dreams. This quantity was rigorously verified using the advanced accounting analytics of a 40-years-old, 100MB Microsoft Excel spreadsheet that achieved semi-sentience in the process.

4 EXPERIMENTS

Contemporary researchers often resort to the use of automatic differentiation in order to skip writing the backward pass, in a shameful effort to avoid undue mathematical activity. We instead opt to explicitly write the backward pass and employ symbolic integration to derive the forward pass. Thanks to advances in computational algebra (Wolfram, 2013), this method almost never forgets the $+C$. Our method can then be implemented in just seven lines of Python code (see Fig. 2).

To rigorously demonstrate the scientific contribution of our work, we conducted a large-scale experiment on a home-spun dataset of both branded and unbranded products. Example outcomes of this experiment can be seen in Fig. 3.

³For the most vibrant rainbow we conduct all transactions in a combination of Swiss Francs and Australian Dollars

Efficacy was assessed quantitatively through a human preference study. Unfortunately, lacking both US and non-US credit cards, we were unable to procure the large sample pool of Amazon Mechanical Turkmen and Turkwomen required to achieve statistically significant results. We therefore turned to our immediate family members to perform the assessments. To maintain the validity of the results, these experiments were performed doubly-blindfolded, following the rules of the popular party game “pin the tail on the donkey”. The instructions to each blood relative stated simply that if they loved us, they would rate the second product more highly than the first. While there was considerable variance in the results, the experiment was a conclusive one, ultimately demonstrating both the potential of our approach and the warm affection of our loved-ones. Comparisons to competing methods were conducted, but removed from the paper when they diminished the attractiveness of our results.

Reproducibility: Much has been written of late about the nuanced ethics of sharing of pretrained models and code by the sages of the field (see e.g. OpenAI (2019) and Lipton (2019) for complementary perspectives). As adequately demonstrated by the title of this work, we are ill-qualified to contribute to this discussion, choosing instead to fall back to the tried and true research code release with missing dependencies, incorrectly set hyper-parameters, and reliance on the precise ordering of `ls` with Linux Kernel 2.6.32 and ZFS v0.7.0-rc4. This should allow us replace public concern about our motives with pity for our technical incompetence.

5 CONCLUSION

The theory of deep learning may be solved but the music need not stop. In this work, we have made a brief but exciting foray into a new avenue of career opportunities for deep learning researchers and enthusiasts. Nevertheless, we acknowledge that there may not be room enough for us all in the espionage racket and so we also advocate responsible preparation for the bitter and frosty depths of the upcoming AI employment winter. To this end, we have prepared a new line of reasonably priced researcher survival kits—each will include a 25-year supply of canned rice cakes, a handful of pistachios, a “best hit” compilation of ML tweets in calendar form, and an original tensor-boardgame, a strategic quest for the lowest loss through the trading of GPUs and postdocs. Collectively, these items will keep spirits high and bring back fond memories of those halycon days when all that was required to get a free mug was a copy of your résumé. The kits will be available to purchase shortly from the dimly lit end of the corporate stands at several upcoming conferences.

REFERENCES

- Volker Blanz, Thomas Vetter, et al. A morphable model for the synthesis of 3d faces. In *Siggraph*, volume 99, pp. 187–194, 1999.
- BoredYannLeCun. #ConvolutionalCriminal <https://twitter.com/boredyannlecun/status/1055609048412930048>, 2018.
- Robert Fortune. *Three Years’ Wanderings in the Northern Provinces of China: Including a Visit to the Tea, Silk, and Cotton Countries; with an Account of the Agriculture and Horticulture of the Chinese, New Plants, Etc.* Number 34944. J. Murray, 1847.
- David F Fouhey and Daniel Maturana. The kardashian kernel, 2012.
- C. Giaimo. One of the earliest industrial spies was a french missionary stationed in china. *Altas Obscura*, 2014.
- U Grenander. Lectures in pattern theory i, ii and iii: Pattern analysis, pattern synthesis and regular structures. *Springer-Verlag*, 1976-81.
- Eric Jang, Shixiang Gu, and Ben Poole. Categorical reparameterization with gumbel-softmax. 2017. URL <https://arxiv.org/abs/1611.01144>.
- Zachary C. Lipton. Openai trains language model, mass hysteria ensues. <http://approximatelycorrect.com/2019/02/17/openai-trains-language-model-mass-hysteria-ensues/>, 2019.

- Matthew M Loper and Michael J Black. Opendr: An approximate differentiable renderer. In *European Conference on Computer Vision*, pp. 154–169. Springer, 2014.
- Dougal Maclaurin, David Duvenaud, and Ryan Adams. Gradient-based hyperparameter optimization through reversible learning. In *International Conference on Machine Learning*, pp. 2113–2122, 2015.
- Chris J Maddison, Andriy Mnih, and Yee Whye Teh. The concrete distribution: A continuous relaxation of discrete random variables. *arXiv preprint arXiv:1611.00712*, 2016.
- OpenAI. Better language models and their implications. <https://openai.com/blog/better-language-models/>, 2019.
- Prometheus. Fire: an insider’s guide. In *Proceedings of the Mt. Olympus Conference on Technology*, date unknown.
- Florian Tramèr, Fan Zhang, Ari Juels, Michael K Reiter, and Thomas Ristenpart. Stealing machine learning models via prediction apis. In *25th {USENIX} Security Symposium ({USENIX} Security 16)*, pp. 601–618, 2016.
- Stephen Wolfram. Computer algebra: a 32-year update. In *Proceedings of the 38th International Symposium on Symbolic and Algebraic Computation*, pp. 7–8. ACM, 2013.

A APPENDIX



Figure 4: UK cloud-cover at the time of submission.

What is the best game console?

A free-market-based approach

Dr. Tom “I Only Write Chess Papers Now” Murphy VII Ph.D.*

1 April 2020

1 Introduction

This is a tale of parallels: Two worlds interconnected by a beautiful symmetry: The two worlds being: Video Games, and, symmetrically: the Stock Market.

Since Curry and Howard were first found to be isomorphic, mathematics has regularly deployed connections between seemingly unrelated fields to solve problems. Here, again, we weave such a tangled web. We make use of an elegant bijection between game consoles and publicly-traded securities to use well-known theorems from one domain (the efficient market hypothesis) to solve an open problem in another: What is the best game console?

This question has vexed us for some time, as has the stock market. Even in the earliest days of video game consoles, it was very annoying when your friend had a ColecoVision and you had an Atari 2600, even if the friend had the expansion that allowed it to play Atari games. The friend would beat you in the game of Combat, but you could swear it was because of the console’s inferior, imprecise controllers. At the end of the 1980s the console wars really began to heat up, with zealous gamers forming factions around popular brands like Nintendo and Sega. Each had their own mascots and lifestyle magazines. The number of bits were growing exponentially. Few families could afford multiple video game systems, and those that did found their houses torn asunder by infighting. Which console would be hooked to VHF Channel 3, and which to the slightly superior Channel 4?

The antipathy continues to this day and does not seem to be resolvable by traditional means (spec comparison tables, forum posts, console exclusives). Perhaps the problem is too emotional to be solved by direct analysis. This is where the current approach really shines: By transforming the problem into a different domain (one ruled by the emotionless *homo economicus* [4]) we can address the problem with pure reason.

The stock market is completely rational, by definition [1]. Prices of securities reflect the exact actual value of the underlying physical good (for example, a basket of option contracts intended to synthetically reproduce the inverse of the day-to-day change in forward 3-month USD LIBOR, as determined by Eurodollar futures [2]) at each moment

*Copyright © 2020 the Regents of the Wikiplia Foundation. Appears in SIGBOVIK 2020 with the trailing stop of the Association for Computational Heresy; *IEEEEE!* press, Verlag-Verlag volume no. 0x40-2A. 100 basis points

in time. This is why they change so often: The value of everything around you is rapidly changing, thousands of times per second. We can use this to understand what console is best (i.e., has the greatest value), by constructing an isomorphism.

2 Methodology

To create an isomorphism, we need to represent each object in one domain (game consoles) with an object in the other (stock market). This is surprisingly easy to accomplish for many consoles. Game consoles have a standard set of abbreviations that are used so that people don't have to write out e.g. "Nintendo Entertainment System" every time. As it turns out, many of these abbreviations are also symbols of publicly-traded securities in the stock market.

There are many dozens of video game consoles [5, 6], not all of which have standardized abbreviations [3]. Therefore, the isomorphism here is technically a *partial best-effort* isomorphism. We find 14 consoles that have a natural counterpart in the stock market. These are given in Table 1, which is the next three pages.

3 Putting my money where my mouth is

Having identified 14 suitable console–security pairs, the next step is to invest money in the market. In March 2019, in preparation for SIGBOVIK 2020, I purchased shares of each of these 14 securities. In order to create a balanced portfolio, I acquired approximately \$100 USD of each; since prices range from less than 3¢ to \$131, this of course meant buying a different quantity of each. The actual amounts are given in Figure 3. Some of these symbols trade on foreign exchanges using other currencies, which is a headache at tax time.

There are many consoles that have no corresponding symbol on any exchange (i.e. they are privately held). This includes popular consoles like Nintendo 64 (N64), Wii (WII), XBox 360 (X360), Neo Geo Pocket Color (NGPC), and so on. There are some whose securities were too exotic for even the ambitious author to acquire. For example, PlayStation Vita (PSV), trades on the Johannesburg Stock Exchange, which is not among the 140 exchanges supported by Interactive Brokers. DreamCast, abbreviated DC, is futures on Class III Milk (milk solids used to make cheese and whey). While this trades readily on the Chicago Mercantile Exchange, you have to be careful about buying Class III Milk futures because you might end up with a bunch of Class III Milk instead of money or video games. Many obscure or fabled consoles (Figure 1) were treated as out-of-scope.



Figure 1: This video game store in Ambergris Caye, Belize, sells games for the fabled PlayStation $2/3$.

Console	Code	Symbol	Exchange	Trades as
Nintendo Game Boy	GB	GB	TSXV (Toronto)	Ginger Beef Corp.
<p>When I was a game boy of about ten years old, my parents forbade me from having a Game Boy, even if purchased with a sock full of dimes that I had personally found around the house and thus made my own property, because “if Nintendo is an addiction, this is like a flask.” These same parents also referred to Nintendo games as “tapes.” This little pocket monster from 1989 was the birthplace of the Pokémon video game series.</p> <p>Fun Fact: The second most popular IEEE standard, IEEE-1394 (a.k.a. “FireWire”), has its connector designed after the Game Boy’s link cable.</p>				<p>Ginger Beef Corp., through its subsidiaries, engages in the operation of franchised take out/delivery service restaurants and the production of frozen and ready-to-serve deli Chinese food products for distribution to retail outlets. The company was founded on April 26, 2000 and is headquartered in Calgary, Canada.</p>
Nintendo DS	NDS	NDSN ¹	NASDAQ (New York)	Nordson Corp.
<p>Nintendo’s “Dual Screen” handheld, released November 2004. The title <i>Nintendogs</i> was conceived due to a typo of this console’s name.</p>				<p>Nordson Corp. engages in the engineering, manufacture and market of products and systems used for adhesives, coatings, sealants, biomaterials and other materials. It operates through three segments: Adhesive Dispensing, Advanced Technology, and Industrial Coating Systems. The company was founded in 1954 and is headquartered in Westlake, OH.</p>
Sega Genesis	GEN	GEN	NYSE (New York)	Genesis Healthcare Inc.
<p>Genesis does what Nintendon’t! This 16-bit console from 1989 competed directly against the Super Nintendo. In South Korea, it was known as the Super Gam*Boy. Who knows what the * stands for?</p>				<p>Genesis Healthcare, Inc. is a holding company, which engages in the provision of inpatient services through skilled nursing and assisted and senior living communities. It also offers rehabilitation and respiratory therapy services. It operates through the following segments: Inpatient Services, Rehabilitation Therapy Services, and Other Services. The company was founded in 1985 and is headquartered in Kennett Square, PA.</p>
Sega Game Gear	GG	GG	NYSE (New York)	Goldcorp Inc.
<p>This color hand-held platform came out in 1991, competing against the 4-shades-of-beige Game Boy. With 3–5 hours of play time on six AA batteries, what’s not to love?</p>				<p>Goldcorp is one of the world’s fastest growing senior gold producers, with operations and development projects located in safe jurisdictions throughout the Americas. The Company is committed to responsible mining practices and is well positioned to deliver sustained, industry-leading growth and performance. The company is headquartered in Vancouver, British Columbia.</p>

¹The standard abbreviation is NDS, but an additional N can be added to emphasize that this is Nintendo’s Nintendo DS, not another company’s Nintendo DS.

Console	Code	Symbol	Exchange	Trades as
PlayStation (original)	PSX	PSX	NYSE (New York)	Phillips 66
PlayStation began as a CD-ROM expansion for the SNES! But then Nintendo was like j/k we are going to make one with Philips instead! But then Nintendo was like j/k also about that, and made the Nintendo 64. Philips went on to release the abysmally bad console called CD-i, making full spiteful use of their contractual rights to Nintendo characters with abysmally bad titles like <i>Hotel Mario</i> . Sony went on to make the PlayStation, mostly for revenge.				Phillips 66 engages in the processing, transportation, storage, and marketing of fuels and other related products. The company operates through the following segments: Midstream, Chemicals, Refining and Marketing & Specialties. Phillips 66 was founded on April 30, 2012 and is headquartered in Houston, TX.
Sony Playstation 3	PS3	PS3	FWB (Frankfurt)	Agilysys Inc.
The X in "PSX" stands for the × symbol in the PlayStation's official occult incantation: △ ○ × □. The 3 in "PS3" stands for the other three symbols. This console followed the PlayStation 2 and was released in 2006. It's sort of like the PlayStation 2 but moreso.				Agilysys, Inc. operates as a technology company. It offers innovative software for point-of-sale, payment gateway, reservation and table management, guest offers management, property management, inventory and procurement, analytics, document management, and mobile and wireless solutions and services to the hospitality industry. The firm also serves the gaming for both corporate and tribal; hotels resort and cruise; foodservice management; and restaurants, universities, stadia, and healthcare sectors. The company was founded in 1963 and is headquartered in Alpharetta, GA.
Sony Playstation 4	PS4	PS4	FWB (Frankfurt)	Phoenix Solar Aktiengesellschaft
Well, what do you know: They keep making PlayStations. In fact, the PlayStation 5 was announced in 2019, but is still privately traded; it is expected to IPO in late 2020.				Phoenix Solar AG operates as holding company, which engages in the development, manufacture, sale, and operation of photovoltaic plants and systems. It operates through the following segments: USA, Middle East, Asia/Pacific, Europe, and Holding Company. The company was founded on November 18, 1999 and is headquartered in Sulzemoos, Germany.
PlayStation Portable	PSP	PSP	NYSEARCA (New York)	Invesco Global Listed Private Equity ETF
Unique for using optical discs for storing its games, this 2005 portable disc-man was fairly successful. It is technically more powerful than the contemporaneous Nintendo DS, but ultimately sold 80 million fewer units than it.				The Invesco Global Listed Private Equity ETF (Fund) is based on the Red Rocks Global Listed Private Equity Index (Index). The Fund will normally invest at least 90% of its total assets in securities, which may include American depository receipts and global depository receipts, that comprise the Index.
Nintendo Entertainment System	NES	NES	NYSEARCA (New York)	Nuverra Environmental Solutions Inc.
This grey 8-bit family computer from 1985 was the breakthrough console for Nintendo, before we even knew that we would have to keep getting consoles every few years. Several Nintendo franchises were born here: Zelda, Metroid, Kirby, Punch-Out!!, and Wii Fitness.				Nuverra Environmental Solutions, Inc. engages in the provision of water logistics and oilfield services. It focuses on the development and ongoing production of oil and natural gas from shale formations in the United States. It operates through the following segments: Northeast Division, Southern Division, Rocky Mountain Division, and Corporate or other. The company was founded on May 29, 2007 and is headquartered in Scottsdale, AZ.

Console	Code	Symbol	Exchange	Trades as
<p>Super Nintendo Entertainment System</p> <p>At the time this console was released in 1990, it was believed that all progress followed a trajectory consisting of <i>X</i>, Super <i>X</i>, Mega <i>X</i>, Hyper <i>X</i>, Giga <i>X</i>, Uultimate <i>X</i>, and then <i>X</i> Infinite. This was eventually disproved by its successor, the Nintendo 64.</p>	SNES	SNES	NASDAQ (New York)	Senestech Inc.
<p>Nintendo GameCube</p> <p>Technically a rectangular prism, the GameCube is a tiny-disc-based system that followed the Nintendo 64. It was released in 2001.</p>	GCN	GCN	TSXV (Toronto)	Goldcliff Resource Corporation
<p>Nintendo Switch</p> <p>Following the relatively unsuccessful and confusingly-named Wii U, Nintendo somehow made itself quite relevant again with this hybrid home/portable console (this is perhaps to what the “Switch” refers). Released in 2017, its competition includes powerful boxes such as the XBox One and PS4.</p>	NS	NS	NYSE (New York)	NuStar Energy L.P.
<p>WonderSwan Color</p> <p>The WonderSwan Color is a hand-held gaming console released by Bandai in 2000. It followed the WonderSwan (makes sense) and preceded the SwanCrystal (??). The console was modestly successful in Japan with about 100 games, but ultimately lost in popularity to Nintendo’s Game Boy Advance.</p>	WSC	WSC	NASDAQ (New York)	Willscot Corporation
<p>XBox One</p> <p>Microsoft is expert at creative counting. We have Windows: 1, 2, 3, 3.1, 3.11 For Workgroups, 95, CE, 98, 98b, NT, ME, 2000, XP, Server 2003, Vista, 7, 8, 8.1, 10. For XBox: XBox, 360, One, One S, One X, Series X (which will be called simply “XBox”). Only the XBox One is publicly traded.</p>	XONE ²	XONE	NASDAQ (New York)	ExOne Co.

Table 1: Isomorphism between video game consoles (left columns) and stock market (right columns).

²There is not consensus on this abbreviation; Wikipedia uses XBO for example.

EUR.USD IDEALPRO ●	1.14070	+1180	6.00K	69.5
European Monetary...	1.14065– 1.14070	1.05%		
GB VENTURE	C0.120		500	0
GINGER BEEF COR...	0.085– 0.190			
GCN VENTURE	0.140	-0.005	1.00K	-15.0
GOLDCLIFF RESOU...	0.140	-3.45%		
GEN NYSE	H1.44	-0.15	75	-10.9
GENESIS HEALTHC...		-9.18%		

Figure 2: Market excitement on the day the experiment ends! The contract at the top (Euro–US Dollar exchange rate) is well-behaved, with a bid–ask spread of half a basis point. Ginger Beef Corp GB’s spread is nuts: It is the difference between a total valuation of \$1.13M and \$2.54M Canadian. Genesis Healthcare has unlocked an achievement: Trading was halted with the last sale at \$1.44 (H1.44) due to its price dropping so much.

4 A watched dollar never bills

The next step of the process is to wait it out. If you wish to follow along, place an opaque sheet of paper over the time-series in Figure 4 and move it at the desired pace, revealing information about the performance of each investment. Major video-game events are labeled on this figure, so you can also do a spit-take in real time as decade-tenured Nintendo CEO Reggie Fils-Aimé steps down and is replaced by a man whose name is really... Doug Bowser?

5 Putting my mouth where my money is

Finally, after a year of investing, it is time to divest and reap the monetary harvests. Selling stocks is the simple inverse of buying them.

One surprise is that on March 9th, the first trading day after one year of holding, the stock markets were very active (I think that this was excitement due to an announcement of a new type of beer from the Corona beverage company?). Two issues arose (Figure 2):

- The bid–ask spread became quite wide. There are really two prices for a security: The “bid” (the highest amount that someone is currently willing to pay to buy it) and the “ask” (the lowest amount that someone is willing to sell it for). Gamers can perhaps think of this like the “new” vs. “used” price for a console. When the market is functioning correctly, these prices are typically within a few cents of one another. The issue was even worse for symbols that have low volume (number of trades/day).

For example, GB had a bid of 0.085 CAD and an asking price of 0.190—more than twice the price! Since I tried to get a favorable price when selling the portfolio, this delayed some divestment for several days.

- Due to much market excitement, trading was halted for many securities! This happens automatically on some exchanges when the price changes more than some amount (say, 15%) in one day, in order to prevent “flash crashes” (this is where an SSD drive fails and loses important banking data). Halted trading of course also delays divestment.

The final balance is displayed in Figure 3; these are the prices actually paid or proceeds actually received.

Symbol	Date (2019)	Bought (Num @ Price)	Cost Basis	Date (2020)	Sold (Num @ Price)	P&L (USD)
XONE	3/8	10 @ 9.302	93.02 USD	3/9	10 @ 5.1927	(\$41.09)
WSC	3/8	10 @ 9.97	99.70 USD	3/9	10 @ 13.17	\$32.00
SNES	3/8	100 @ 1.0973	109.73 USD	3/9	5 @ 2.05	(\$99.48)
PSX	3/8	1 @ 94.1073	94.10 USD	3/9	1 @ 65.601	(\$28.50)
PSP	3/8	9 @ 11.1273	100.15 USD	3/9	9 @ 10.395	(\$6.60)
NS	3/8	4 @ 26.88	107.52 USD	3/9	4 @ 16.29	(\$42.36)
NDSN	3/8	1 @ 131.2673	131.27 USD	3/9	1 @ 134.64	\$3.37
GG	3/8	10 @ 10.62	106.20 USD	3/9	3 @ 49.16	\$41.28
GEN	3/8	75 @ 1.36	102.00 USD	3/9	75 @ 1.415	\$4.13
NES	3/8	11 @ 9.4973	104.47 USD	3/9	11 @ 2.53	(\$76.64)
GCN	3/8	1000 @ 0.08	80.00 CAD	3/9	1000 @ 0.12	\$29.29
GB	3/8	500 @ 0.185	92.50 CAD	3/12	500 @ 0.085	(\$37.25)
PS3	3/12	5 @ 18.29	91.45 EUR	3/9	5 @ 22.2	\$24.23
PS4	3/12	3000 @ 0.0267	80.10 EUR	3/10	3000 @ 0.013	(\$45.46)
Total:	5	NaN	1366.34 USD	91/20	NaN	(\$243.08)

Figure 3: Actual transaction data from the experiment. Each security has a date on which some quantity (around \$100 USD) was bought (“Cost Basis”) and a date on which the entirety was sold for some consequent profit or loss (P&L). Note that the number bought is not always equal to the number sold. In the case of SNES, there was a 20:1 reverse split (reverse splits happen to keep the price from getting embarrassingly low: It would be 10.2¢ in this case). GG was acquired, so the sale was actually of a different symbol (NEM). The P&L column and totals have been converted to USD using historic forex rates. Prices omit transaction fees, which are significant especially for non-US exchanges.

6 Results

Most of these investments lost money, as did the overall portfolio. Both the SNES and NES performed very badly, which was a disappointment to me, since these are my two favorites. But this is exactly why this approach is needed: It removes the emotional

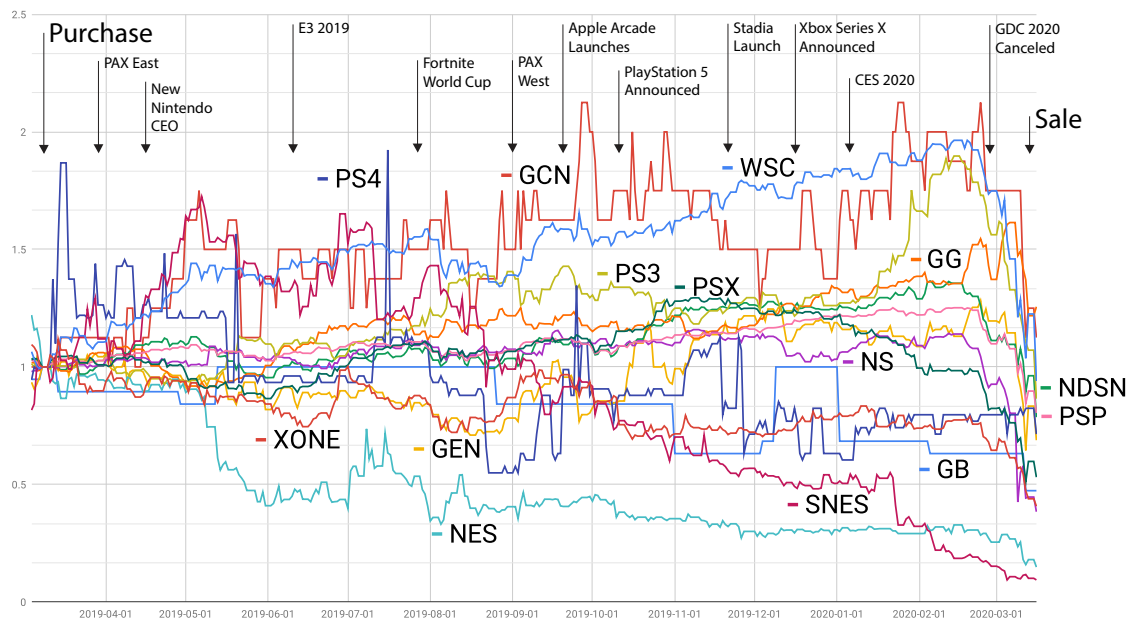

Figure 4: Relative daily closing price for the fourteen publicly-traded video game stocks in the experiment. The closing price is adjusted in arrears for dividend payments and splits. Each price is 1.0 on the date of acquisition (9 March 2019) and other closing prices are given relative to this value. For example, GCN was briefly worth more than twice its starting price at the end of September.

component. Both of these fell relentlessly throughout the year and lost more than 90% of their value. The best overall were the Game Gear (GG) and WonderSwan Color (WSC) with PlayStation 3 and GameCube also performing well.

It is interesting how little the game consoles react to major video game news (Figure 4). The announcement of the PlayStation 5 in October didn't seem to cause any movement; this is especially odd for the PlayStation 4 whose value is normally quite volatile. One hypothesis is that this information was already "priced in." October was when the name "PlayStation 5" was officially unveiled; the successor to the PlayStation 4 had been rumored for some time, but its name was a complete mystery. Arguably, only the cancellation of GDC had any real effect on prices.³

³Also the event marked "Sale", which is when the experiment ended. It seems like a joke that this would affect the market, but this is literally true for extremely low-volume stocks where my transaction may have been a significant portion of the day's activity. You can tell a low-volume stock from long flat horizontal lines.

7 Is this the most expensive SIGBOVIK paper?

Probably not.

8 Are video games a good investment?

The efficient market hypothesis tells us that every contract is priced according to the true value of the underlying good. In this sense, every transaction is value-neutral, and money can only be made or lost by predicting the future value of goods. With no information about the thing being bought, as is the case for a basket of random stocks, the investment should technically not gain or lose money (in expectation).

Of course, we do know another theorem about the stock market, from economics: The market always goes up in the long-run! The US Government considers a year to be “long term” for the sake of capital gains tax, so we should expect that randomly selected stocks increase in value over this long term.

So why, in fact, did this investment lose 17.8% of its value? This is because the stocks are not randomly selected; they represent video game consoles. Because video games are high-tech items which rapidly become out of date, they actually tend to *depreciate* with time. Only a few beloved classic consoles gained in value, for nostalgia reasons.

So this finally allows us to answer the question: What is the best game console? And the answer, established with an elegant isomorphism:

All video game consoles are bad.

References

- [1] Louis Bachelier. Théorie de la spéculation. *Annales scientifiques de l'École Normale Supérieure*, 3e série, 17:21–86, 1900.
- [2] Citigroup Global Markets Holdings Inc. VelocityShares Short LIBOR ETN. <https://www.velocityshares.com/etns/product/dlbr/>.
- [3] The Mega-Man Homepage. Glossary: Game systems. <http://www.mmhp.net/Glossary.html>.
- [4] Vilfredo Pareto and AN Page. Manuale di economia politica (manual of political economy). *Schwier, AS, Transl*, 1906.
- [5] Wikipedia. List of handheld game consoles. http://en.wikipedia.org/wiki/List_of_handheld_game_consoles.
- [6] Wikipedia. List of home video game consoles. http://en.wikipedia.org/wiki/List_of_home_video_game_consoles.



CONFIDENTIAL COMMITTEE MATERIALS

SIGBOVIK'20 3-Blind Paper Review

Paper 30: What is the best game console?: A free-market–based approach

Reviewer: Count Dracula, Sesame St, Cyberspace

Rating: Great execution of absurd idea.

Confidence: Based on counting irrelevant but objective things like vowel pairs in the paper, absurdly high. But measures like that are not confidence-inspiring, so on balance, low.

Masterful job of optimizing an “objective” measure by gaming the data.

This is a poster-child for the application of Goodhart’s Law and the vacuousness of so-called “objective” rankings that blindly count stuff – like h-index and impact factors

Can a Paper Be Written Entirely in the Title? 1. Introduction:
The Title Pretty Much Says it All. 2. Evaluation: It Gets the Job
Done. However, the Title is a Little Long. 3. Conclusion: Yes.

Daniel Gaston
University of Delaware



CONFIDENTIAL COMMITTEE MATERIALS

SIGBOVIK'20 3-Blind Paper Review

Paper 9: Can a paper be written entirely in the title? 1. Introduction: The title pretty much says it all. 2. Evaluation: It gets the job done. However, the title is a little long. 3. Conclusion: Yes.

Reviewer: Skirt Steak

Rating: 100%

Confidence: Kim Possibly Confident

While the immediate academic implications of this paper are deep and far-reaching, a more thorough analysis reveals that it also has carefully hidden, previously undiscovered lore on the hit American television series *Cory in the House*, featuring Kyle Massey and Jason Dolley.

The first tip-off is found even before reaching the paper itself in the author's pseudonym, which is a pseudonym for "Cory Baxter". This is a subtle nod to Cory Baxter, the main character of *Cory in the House*.

In the second paragraph, we find the real hidden jewel of lore. By taking the first letter of every sentence in this paragraph and placing them in reverse order, a working URL is revealed. Each time the URL is opened, it has a 50% to redirect to either of two pages: Webkinz.com, and the Wikipedia page for Jeff Bezos. It is a little known fact that Cory's favorite game is Webkinz. It follows that Cory's favorite multibillionaire American internet and aerospace entrepreneur, media proprietor, and investor is Jeff Bezos.

An extra nugget of lore is planted in the final paragraph, in the last sentence, in the last letter. By examining the lower edge of the bottom right serif with an electron microscope, you will find Cory himself. This has huge implications for the hit American television series *Cory in the House*, featuring Kyle Massey and Dan Schneider. The only explanation for this observation is that Cory is only slightly taller than a hydrogen atom, and the entire series had to be recorded by shrinking down the rest of the cast and set to an atomic size.

The effort required to make these details subtle yet discernible suggests that the author intended to communicate them secretly to some as-of-yet unidentified group or individual. But the public deserves to hear the truth.

Erdős-Bacon-Sabbath Numbers

Reductio ad Absurdum

Maria Klawe
Harvey Mudd College
Claremont CA 91711

Daniel V. Klein
Google
Pittsburgh PA 15206

D K Fackler
University of Edgestow
Thulcandra

Mary Shaw
Carnegie Mellon University
Pittsburgh PA 15203

Michael Ancas
Crazy Pants Productions
McDonald PA 15057

Augie Fackler
Google
Pittsburgh PA 15206

Sarah R. Allen
Google
Pittsburgh PA 15206

Harry Q. Bovik
Carnegie Mellon University
Doha Qatar

Abstract

A small Erdős number – the “collaborative distance” of authorship between oneself and Paul Erdős – has long been a source of pride for mathematicians, computer scientists and other geeks. Utilizing similar collaborative distance metrics, a small Bacon number (the degree of separation from Kevin Bacon) has been a source of pride for actors, while a small Sabbath number (the degree of separation from Black Sabbath) has been a source of pride for musicians. Previous research in Erdős-Bacon number minimization has reduced the Erdős number of a number of computer scientists to two, which is believed optimal, although the reduction of the Bacon number to four was clearly suboptimal. We extend and improve on this previous work to provide a Erdős-Bacon-Sabbath number minimization that is believed to be close to optimal in all axes.

Derivative Introduction [2]

Paul Erdős co-authored nearly 1500 papers (until his death in 1996), working with nearly 500 collaborators achieving the status of the most prolific mathematician in modern times [4]. Mathematicians thus humorously defined Erdős numbers. A person’s Erdős number is the distance between that person and Paul Erdős in the academic paper collaboration graph [3]. Succinctly, Paul Erdős is the unique person with Erdős number zero; all of Erdős’ immediate co-authors have Erdős number one; in general, if you publish an academic paper with a collaborator who has Erdős number N and none of your other co-authors has Erdős number less than N , your Erdős number is $N + 1$.

A similar Bacon number [16] has been proposed for actor Kevin Bacon, except using collaborations in film instead of collaborations in academic papers. Likewise, a similar Sabbath number [12] has been proposed to connect to the members of

the musical group Black Sabbath, using collaborations in musical performances.

Erdős-Bacon-Sabbath numbers were subsequently defined [5] to be the sum of each person's Erdős, Bacon, and Sabbath numbers.

There is a long tradition of posthumous publication [7], and authors claiming to have collaborated with Erdős have brought his total number of known publications to 1525, his collaborator count to 511, and the Erdős number of the chutzpah-bearing mathematician to one. The latest publications co-written with Paul Erdős appeared more than ten years after his death. With additional rumored works in progress, Erdős's publication list is expected to grow. In fact, Paul Erdős himself has published a solo work 15 years after his death [8].

In this paper, we describe and demonstrate a technique called Erdős-Bacon-Sabbath Number Minimization.

Rules of the Games

The rules of Erdős number calculation are clear: author a paper in a peer-reviewed publication, either with someone connected by co-authorship with Paul Erdős, or with Paul Erdős himself (the latter being unlikely unless pre-demise work is used in a posthumous publication, or if you are better at communicating with the dead than Edgar Cayce). Simply putting Paul Erdős' name on your paper does not count (and changing your name to Paul Erdős for purposes of publication is *definitely* cheating).

The rules of Bacon number calculation [16] are also clear: act in or be otherwise credited in a film with someone connected by film credit with Kevin

Bacon¹, or with Kevin Bacon himself. We tried contacting Kevin Bacon, but his agent refused to put us in touch. We contemplated inserting a fair-use clip of Kevin Bacon from an unrelated movie, but knew that would be cheating (but we *did* think of it).

Finally, the rules of Sabbath number calculation [12] are also clear: connections between a musician and a band or solo artist can only be made if they actually performed or recorded together. However, "session musicians" are valid connections, so musicians who perform live or record with an artist, but are not strictly committed to that band are valid. A new recording [11] can serve as adequate proof, but singing along to a Black Sabbath record is cheating. We also contemplated contacting Ozzy Osbourne, but he postponed the 2019 tour that would have taken him through the Pittsburgh area, and then cancelled the tour altogether.

The theoretically achievable absolute minimum Erdős-Bacon-Sabbath number is two: if Kevin Bacon (who has a Bacon Number of zero) were to become a member of Black Sabbath (thus receiving a Sabbath number of zero), and was to publish a paper with a person with an Erdős number of one (since Paul Erdős is dead, and ineligible as a co-author). The practically achievable minimum Erdős-Bacon-Sabbath number is four (by authoring a paper with a someone with an Erdős number of one, appear in a movie with Kevin Bacon, and perform with a member of Black Sabbath), but the realistically achievable minimum is somewhat higher than that.

¹ The Internet Movie Database <http://www.imdb.com> is typically used for verification of film/video/YouTube credits.

Computation of Erdős, Bacon, and Sabbath Numbers

In [1], Maria Klawe co-authored with Paul Erdős and has an Erdős number of one, thus guaranteeing that all authors on this paper have an Erdős number no greater than two.

Daniel V. Klein has a Bacon number of 2, having appeared in [9] with Steve Guttenberg, who appeared in [10] with Kevin Bacon. Mike Ancas also has a Bacon number of 2, having appeared as an extra in [17] with Tom Hanks, who appeared in [18] with Kevin Bacon. All authors on this paper also appear in the documentary about the writing of this paper [11], and thus have a Bacon number no greater than three.

Additionally, Mike Ancas also has a Sabbath number of 1, having been a member of the Bloomsburg PA High School rock band The Rubber Band. In 1971 The Rubber Band performed as one of several warm-up acts for Ronnie James Dio (who in 1979 became the lead singer for Black Sabbath). The authors of this paper have recorded a special musical piece, composed specifically for this paper, and captured in [11]. Their Sabbath number is therefore no greater than two.²

The combined Erdős-Bacon-Sabbath number for all the authors of this paper is therefore no greater than seven, surpassing the rarified company of the only three other people hitherto known to have an Erdős-Bacon-Sabbath number of eight: Stephen Hawking, Ray Kurzweil, and Daniel Levitin, a professor of psychology and behavioral

² Early research on low Sabbath Numbers included DK Fackler, who has a Sabbath number of 2. DK performed with Roger Daltrey [14] in 1994, who in turn performed in Wembley Stadium with “The Who” at *Live Aid* (1985), where Black Sabbath also performed [15].

neuroscience at McGill University [6]. They now are tied with the previous record-low Erdős-Bacon-Sabbath number (held by Lawrence Krauss [13]) with an Erdős-Bacon-Sabbath number of seven!

Not to brag or nothin’, but Maria Klawe (E=1, B=3, S=2) and Daniel V. Klein (E=2, B=2, S=2) have now beaten that record with an Erdős-Bacon-Sabbath number of six. Finally, with a near-optimal EBS number minimization, Mike Ancas (E=2, B=2, S=1) has algorithmically achieved an incredible Erdős-Bacon-Sabbath number of five!

Sheet Music & Documentary

You’ve read the paper, now read the music (in the appendix)! Lastly, you get to watch the documentary at [11].

Acknowledgements

Thanks, Mom! Thanks, Dad! Thanks to spouse(s) and/or partner(s), significant other(s), groupies, and random tinder dates!

References

- [1] Paul Erdős, Frank Harary, and Maria Klawe. “Residually complete graphs.” In *Proc. Sympos. Combinatorial Mathematics and Optimal Design*, pages 117–123, Colorado State University, Fort Collins, Colorado, 1978
- [2] Charles Garrod, Maria Klawe, Iain Matthews, *et. magnum al.* “An Algorithm for Erdos-Bacon Number Minimization.” In *A Record of The Proceedings of SIGBOVIK 2010*, pages 3-4, Carnegie Mellon University, Pittsburgh, Pennsylvania, 2010

- [3] Caspar Goffman. “What is your Erdős number?” *The American Mathematical Monthly*, 76(7):791, 1969
- [4] Jerry Grossman, Patrick Ion, and Rodrigo De Castro. Erdős number project, 2010.
<http://www.oakland.edu/enp/>.
- [5] Richard Sear. “Erdos-Bacon-Sabbath numbers.” *Times Higher Education*, 2016.
<http://blogs.surrey.ac.uk/physics/2012/09/15/erdos-bacon-sabbath-numbers/comment-page-1/>
- [6] Scott Seckel. “Rarified air: Do you have an Erdos-Bacon-Sabbath number?” University of Arizona, 2016.
<https://asunow.asu.edu/20160126-creativity-lawrence-krauss-erdos-bacon-sabbath-score>
- [7] Myles McWeeney. “Voices from beyond the grave - authors whose legacies live on through posthumous publishing” *The Independent (Ireland)*, 2017.
<https://www.independent.ie/entertainment/books/voices-from-beyond-the-grave-authors-whose-legacies-live-on-through-posthumous-publishing-35804952.html>
- [8] Paul Erdős. “Some Problems On The Distribution Of Prime Numbers.” In: Ricci G. (eds) *Teoria dei numeri*. C.I.M.E. Summer Schools, vol 5. Springer, Berlin, Heidelberg
https://doi.org/10.1007/978-3-642-10892-1_3
- [9] Ravi Godse. “Help Me Help You”, 2009.
<https://www.imdb.com/title/tt1417297/>
- [10] Barry Levinson. “Diner”, 1982.
<https://www.imdb.com/title/tt0083833/>
- [11] Michael Ancas, Daniel Klein. “Creating a Tiny Erdős-Bacon-Sabbath Number for Fun (and No Profit) (2020)”
<https://www.imdb.com/title/tt11833110/>
<https://youtu.be/OI6qkP3yLxw>
- [12] Bill M. “The Black Sabbath Game”, 2003
<http://web.archive.org/web/20031121110828/http://www.imjustabill.com/blacksabbathgame/index.html>
- [13] Scott Seckel. “This guy? He knows people” Arizona State University, 2016.
<https://sese.asu.edu/about/news/article/1645>
- [14] Roger Daltrey. Live in Chicago, 1994.
<http://www.thewholive.net/concert/index.php?id=1423>
- [15] Black Sabbath at “Live Aid”, 1985.
<https://ultimateclassicrock.com/black-sabbath-live-aid/>
- [16] Isabel Teotonio, “Google adds Six Degrees of Kevin Bacon to search engine”, *The Star (Toronto, Canada)*, 2012.
https://www.thestar.com/entertainment/2012/09/13/google_adds_six_degrees_of_kevin_bacon_to_search_engine.html
- [17] Marielle Heller, “A Beautiful Day in the Neighborhood”, 2019
<https://www.imdb.com/title/tt3224458/>
- [18] Ron Howard, “Apollo 13”, 1995
<https://www.imdb.com/title/tt0112384>

Appendix: "Erdős Bacon Sabbath Number Reduction" in A Maj
Daniel V. Klein, op 2+2+3

The first system of the musical score consists of five staves. The top two staves are for the Chorus, with a treble clef on the first and a bass clef on the second. The third staff is for the Clarinet (treble clef), the fourth for the French Horn (bass clef), and the fifth for the Bass (bass clef). The key signature is A major (three sharps) and the time signature is 4/4. The Chorus and Clarinet parts are mostly silent, with a few notes appearing in the final measure. The French Horn and Bass parts play a rhythmic accompaniment of eighth notes.

The second system of the musical score consists of five staves. The top staff is a vocal line with lyrics: "Erdős Bacon Sabbath Number Re-duc-tion Erdős Bacon Sabbath Number Re-duc-tion". The second staff is the Bass line, which continues the rhythmic accompaniment. The third staff is for the French Horn, and the fourth and fifth staves are for the Bass. The key signature and time signature remain the same as in the first system.

Erdős Bacon Sabbath Number Re- duc- tion Re- duc- tion!

Bass

Bass

This musical score is for a piece titled "Erdős Bacon Sabbath Number Reduction". It is written in 4/4 time and the key signature has three sharps (F#, C#, G#). The score consists of five staves. The top staff is a treble clef with a vocal line. The second staff is a bass clef with a vocal line. The third staff is a treble clef with a piano accompaniment line. The fourth and fifth staves are bass clefs with piano accompaniment lines, with the word "Bass" written below the fourth staff. The lyrics are "Erdős Bacon Sabbath Number Re- duc- tion Re- duc- tion!".

This musical score is a piano accompaniment for a piece in 4/4 time and the key signature of three sharps (F#, C#, G#). It consists of five staves. The top two staves are empty. The third staff is a treble clef with a piano accompaniment line. The fourth and fifth staves are bass clefs with piano accompaniment lines.